



# Alfa Laval TZ-89

## Low Flow Impact Cleaning

### Application

The Toftejorg TZ-89 rotary jet head provides 3D indexed low flow impact cleaning over a defined time period. It is suitable for processing, storage and transportation tanks and vessels between 0.5 and 10 m<sup>3</sup>.

### Working principle

The flow of the cleaning fluid makes the nozzles perform a geared rotation around the vertical and horizontal axes. In the first cycle, the nozzles lay out a coarse pattern on the tank surface. The subsequent cycles gradually make the pattern more dense, until a full pattern is reached after 8 cycles. The drive mechanism is located outside the tank or process equipment, leaving a minimum of parts to be submerged into the product.

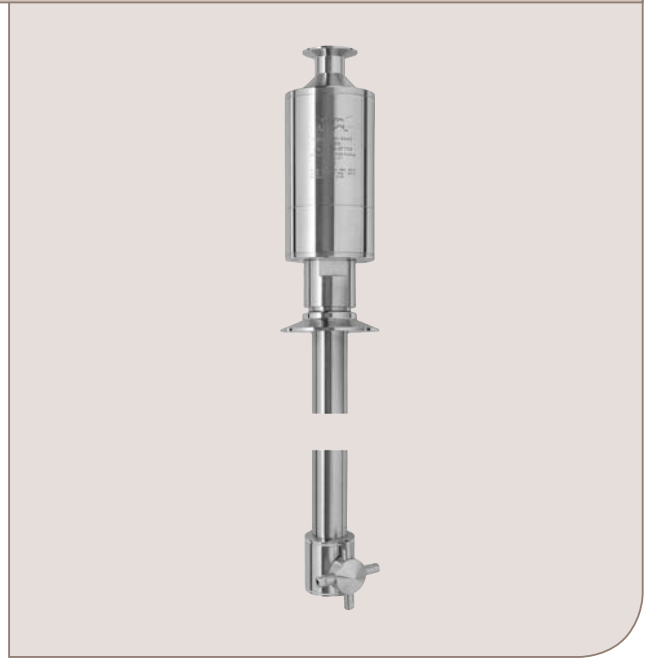

### TECHNICAL DATA

Lubricant: . . . . . Self-lubricating with the cleaning fluid

Standard Surface finish:

Product contact parts: . . . . . Ra 1.0µm

Max throw length: . . . . . 4-7 m

Impact throw length: . . . . . 2.5-4 m

### Pressure

Working pressure: . . . . . 2-7 bar

Recommended pressure: . . . . . 5-6.5 bar

### Cleaning Pattern

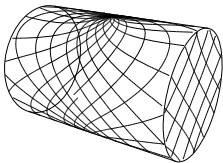

First cycle

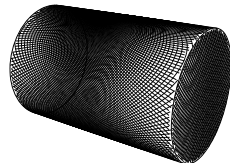

Full pattern

The above drawings show the cleaning pattern achieved on a cylindrical horizontal vessel. The difference between the first cycle and the full pattern represents the number of additional cycles available to increase the density of the cleaning.

### Certificates

2.1 material certificate

### PHYSICAL DATA

#### Materials

316L (UNS S61603), Duplex steel (UNS N31803), PTFE, PEEK, FEP/Silicone

#### Temperature

Max. working temperature: . . . . . 95°C

Max. ambient temperature: . . . . . 140°C

Weight: . . . . . 5.5 - 8.5 kg

#### Connections

Inlet connections: . . . . . Thread: 3/4" Rp (BSP) or NPT, male or  
Clamp: 1" ISO 2852

Tank connection: . . . . . Flange: 50 DN6 DIN 2501, or  
3" ANSI B 16.5 or  
Clamp: 3" or 4" ISO2852

#### Caution

Avoid hard and abrasive particles in the cleaning liquid, as this can cause increased wear and/or damage of internal mechanisms. In general, it is recommended to place a filter in the supply line.

### Flow Rate

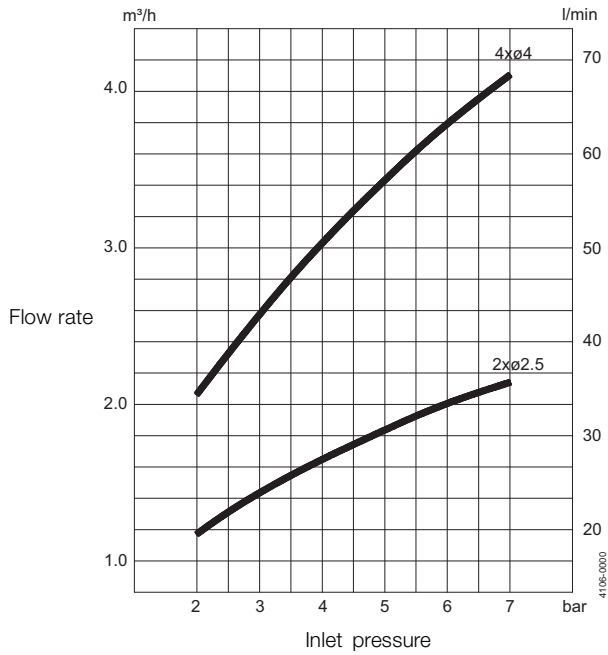

### Impact Throw Length

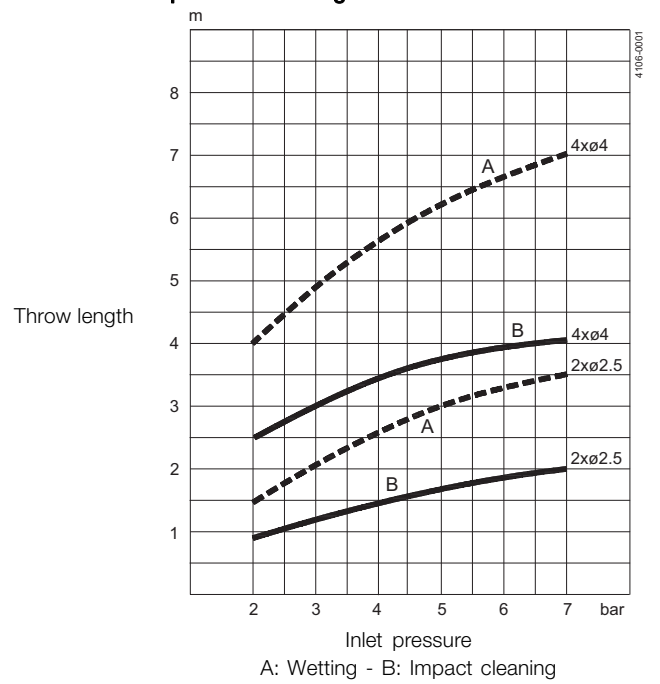

### Dimensions (mm)

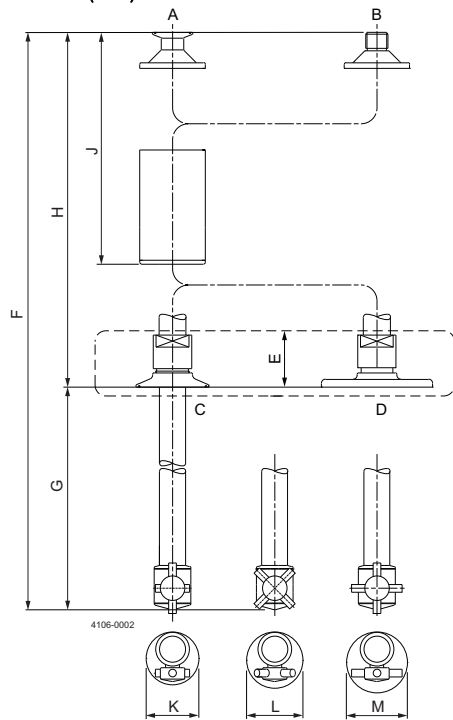

- A: Clamp 1" ISO
- B: Thread 3/4" Rp (BSP) / NPT
- C: Clamp 3" ISO

### Cleaning Time, Complete Pattern

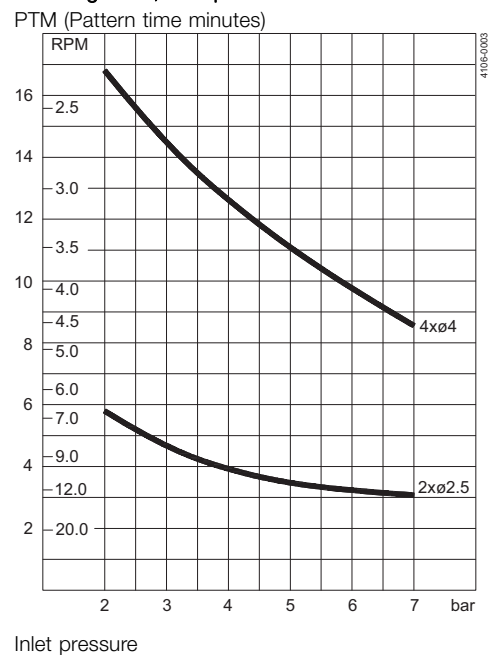

- D: Flange 50ND6, DIN2501 Do=140/PC=110/Db=4xø14 Flange 3" ANSI
- 16.5 1991 Do=190.5/PC=152.4/Db=4xø19
- E: Adjustable

F	G-DPL	H	J	K	L	M
350	Min. 62 Max. 96	Max. 288 Min. 254	190	ϕ69	ϕ72	ϕ79.5
500	Min. 62 Max. 246	Max. 438 Min. 254	190	ϕ69	ϕ72	ϕ79.5
750	Min. 62 Max. 496	Max. 688 Min. 254	190	ϕ69	ϕ72	ϕ79.5
1020	Min. 62 Max. 766	Max. 958 Min. 254	190	ϕ69	ϕ72	ϕ79.5
1270	Min. 62 Max. 1016	Max. 1208 Min. 254	190	ϕ69	ϕ72	ϕ79.5
1500	Min. 62 Max. 1246	Max. 1438 Min. 254	190	ϕ69	ϕ72	ϕ79.5

### Standard Design

Special versions include Tri-Clamp connections and ultra-low flow with fast rotation. As standard documentation, the Toftejorg TZ-89 can be supplied with a "Declaration of Conformity" for material specifications.

### TRAX simulation tool

TRAX is a unique software that simulates how the Toftejorg TZ-89 performs in a specific tank or vessel. The simulation gives information on wetting intensity, pattern mesh width and cleaning jet velocity. This information is used to determine the best location of the tank cleaning machine and the correct combination of flow, time and pressure to implement.

A TRAX demo containing different cleaning simulations covering a variety of applications can be used as reference and documentation for tank cleaning applications. A TRAX simulation is free and available upon request.

### Wetting Intensity

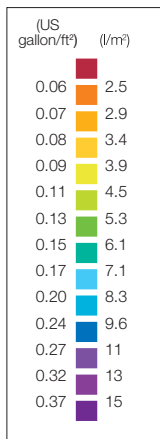

TD 523-208

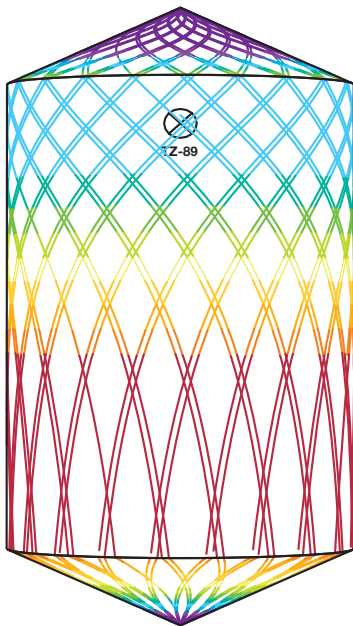

D2m H3m, Toftejorg TZ-89, 4 x ϕ4 mm Time = 2.8 min., Water consumption = 159 l

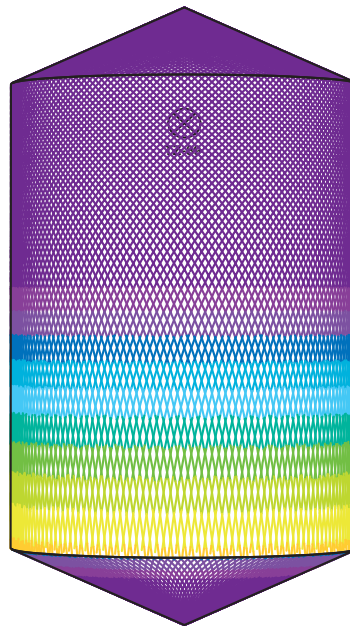

D2m H3m, Toftejorg TZ-89, 4 x ϕ4 mm Time = 11.1 min., Water consumption = 637 l

Alfa Laval reserves the right to change specifications without prior notification.

---

**How to contact Alfa Laval**

Contact details for all countries  
are continually updated on our website.  
Please visit [www.alfalaval.com](http://www.alfalaval.com) to  
access the information direct.