

# Self Priming Centrifugal Pump

*Super*  
**T SERIES**

VARIOUS PATENTS APPLY

## Model T8A71S-B

### Size 8" x 8"



#### PUMP SPECIFICATIONS

**Size:** 8" (203 mm) ASA Flanged Suction x 8" (203 mm) NPT Female Discharge.

**Casing:** Gray Iron 30.

Maximum Operating Pressure 83 psi (572 kPa).\*

**Semi-Open Type, Two Vane Impeller:** G-R Hard Iron.

Handles 3" (76,2 mm) Diameter Spherical Solids.

**Impeller Shaft:** Alloy Steel 4150.

**Shaft Sleeve:** Alloy Steel 4130.

**Replaceable Wear Plate:** G-R Hard Iron.

**Removable Adjustable Cover Plate:** Gray Iron 30.

**Removable Inspection Cover Plate:** Gray Iron 30; 20 lbs. (9,1 kg.).

**Flap Valve:** Neoprene <sup>W</sup>/Nylon and Steel Reinforcing.

**Seal Plate:** G-R Hard Iron.

**Bearing Housing:** Gray Iron 30.

**Radial and Thrust Bearings:** Open Double Row Ball.

**Bearing and Seal Cavity Lubrication:** SAE 30 Non-Detergent Oil.

**Flanges:** Gray Iron 30.

**Gaskets:** Buna-N, Compressed Synthetic Fibers, PTFE, Cork, and Rubber.

**O-Rings:** Buna-N.

**Hardware:** Standard Plated Steel.

**Brass Pressure Relief Valve.**

**Bearing and Seal Cavity Oil Level Sight Gauges.**

**Optional Equipment:** Metal Bellows Seal. Automatic Air Release Valve. 120V/240V Casing Heater. High Pump Temperature Shutdown Kit.

Gray Iron 30 Spool Flanges:

8" ASA Discharge (**Specify Model T8A71S-B /F**).

200 mm DIN 2527 (PN 16) Suction and Discharge

(**Specify Model T8A71S-B /FM**).

\*Consult Factory for Applications Exceeding Maximum Pressure and/or Temperature Indicated.



Shown with Optional Discharge Spool Flange (Available in ASA or DIN Standard Sizes).

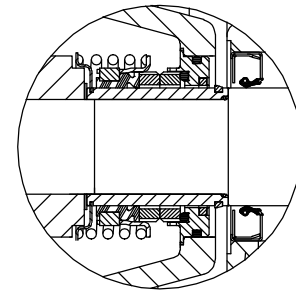
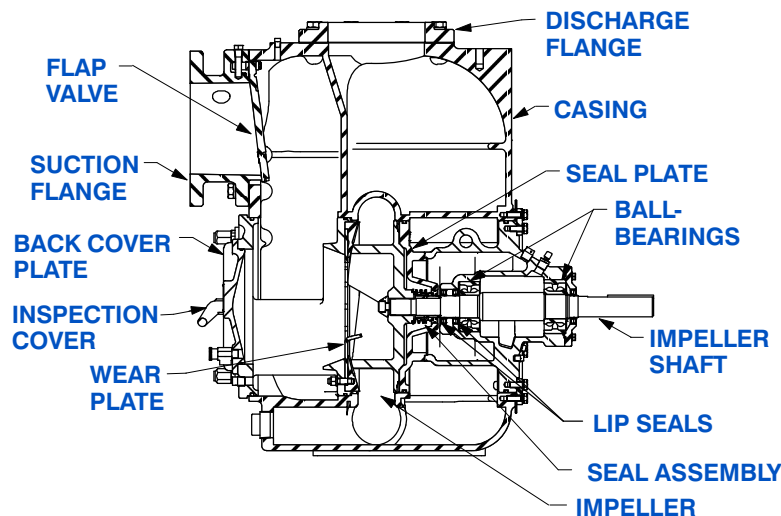

#### SEAL DETAIL

Cartridge Type, Mechanical, Oil-Lubricated, Double Floating, Self-Aligning. Silicon Carbide Rotating and Stationary Faces. Stainless Steel 316 Stationary Seat. Fluorocarbon Elastomers (DuPont Viton<sup>®</sup> or Equivalent). Stainless Steel 18-8 Cage and Spring. Maximum Temperature of Liquid Pumped, 160°F (71°C).\*



## GORMAN-RUPP PUMPS

www.grpumps.com

Specifications Subject to Change Without Notice

Printed in U.S.A.

**Specification Data**

SECTION 55, PAGE 2340C

**APPROXIMATE DIMENSIONS and WEIGHTS**

**NET WEIGHT: 1305 LBS. (592 KG.)\***  
**SHIPPING WEIGHT: 1409 LBS. (639 KG.)\***  
**EXPORT CRATE: 47.9 CU. FT. (1,36 CU. M.)**  
**\*ADD 35 LBS. (15,9 KG.) W/EACH SPOOL FLANGE**

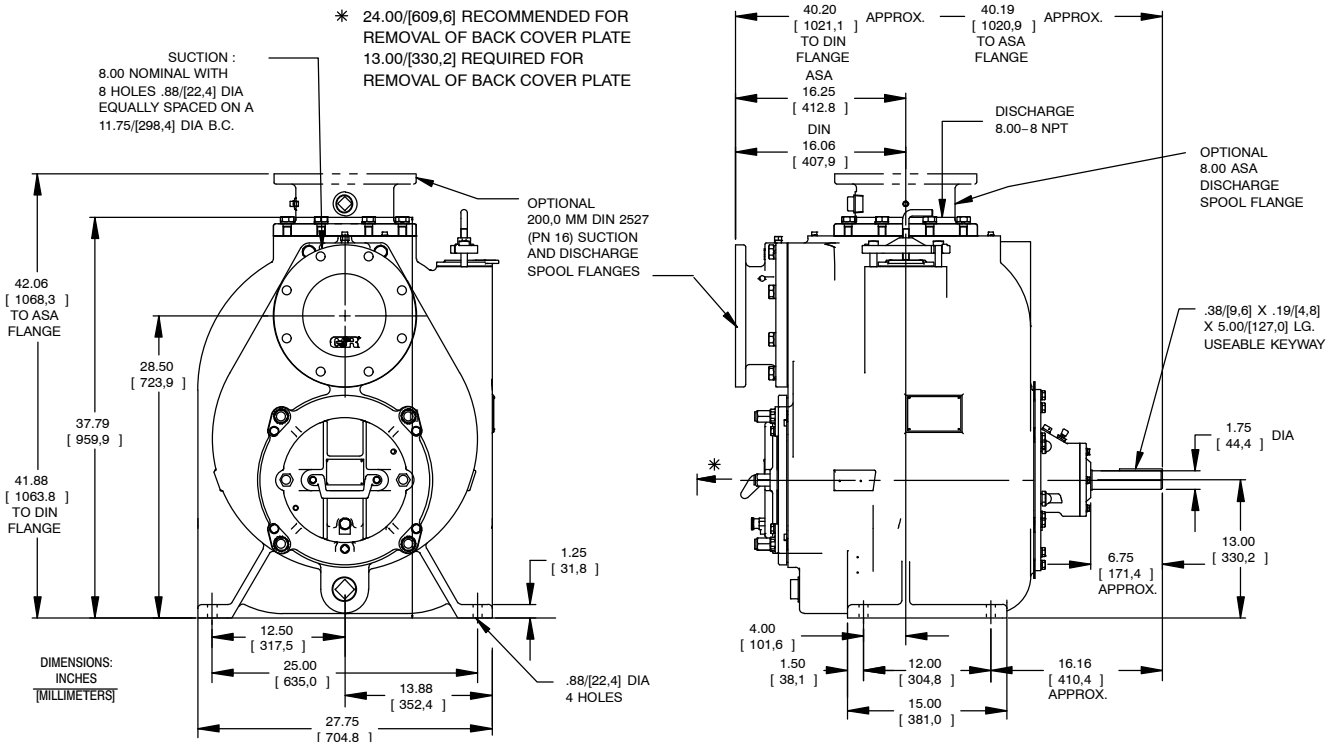

**OPTIONAL ASA OR DIN STANDARD SPOOL FLANGES AVAILABLE**

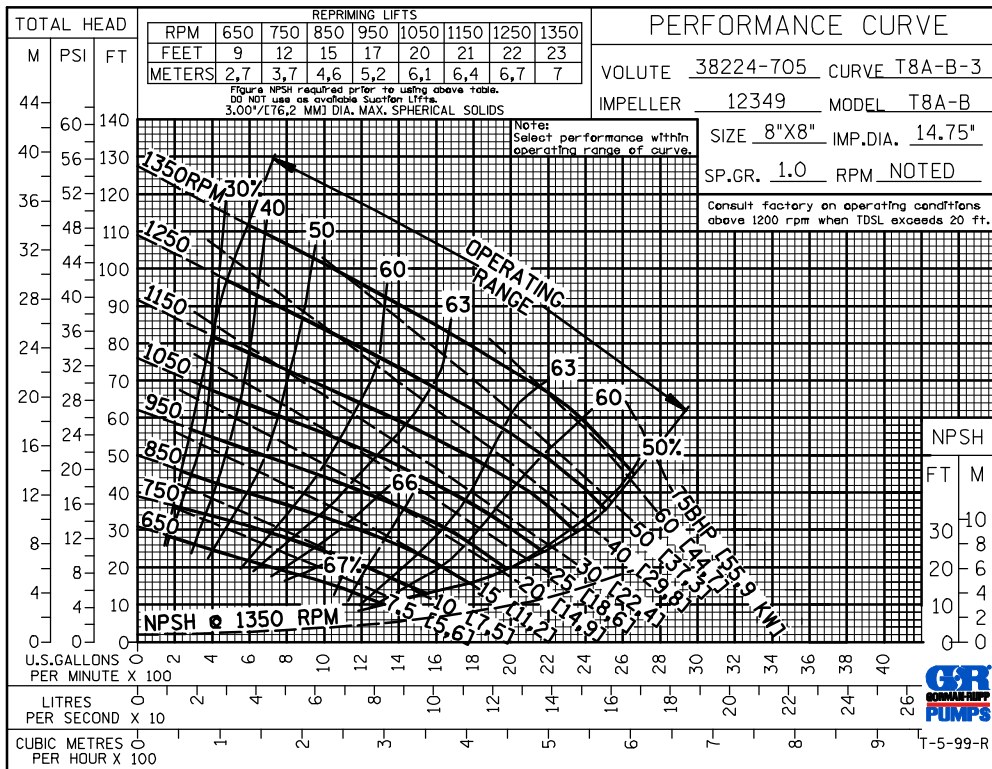

**GORMAN-RUPP PUMPS**

www.grpumps.com

Specifications Subject to Change Without Notice

Printed in U.S.A.

CDS

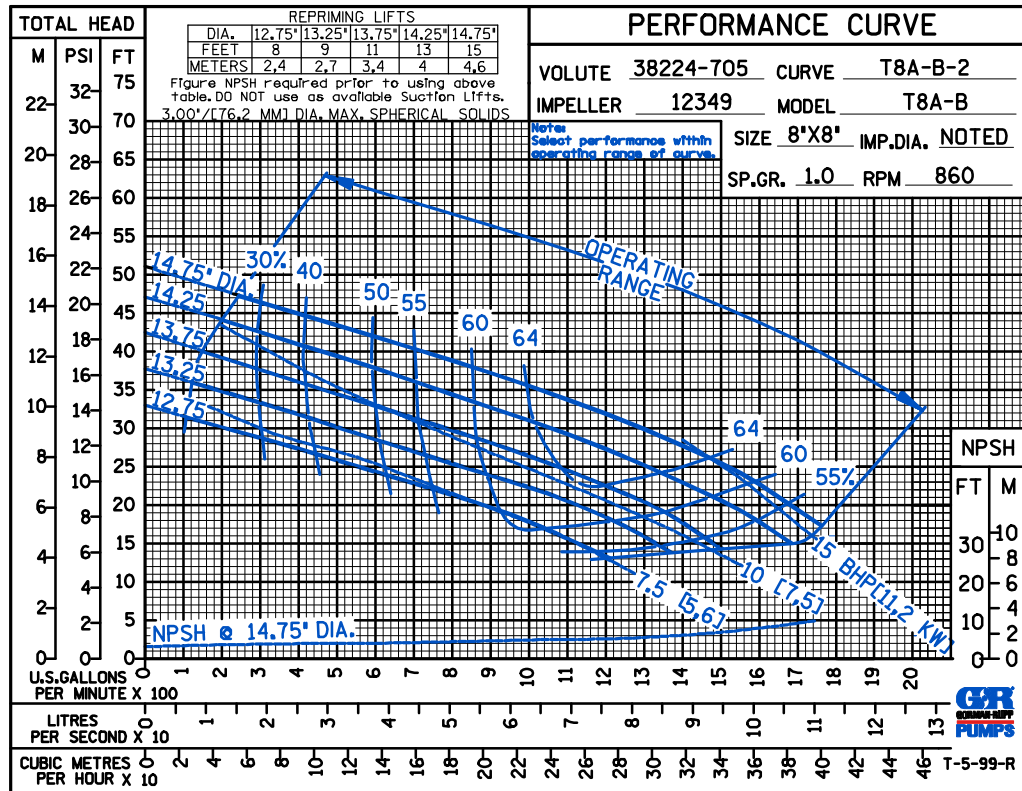
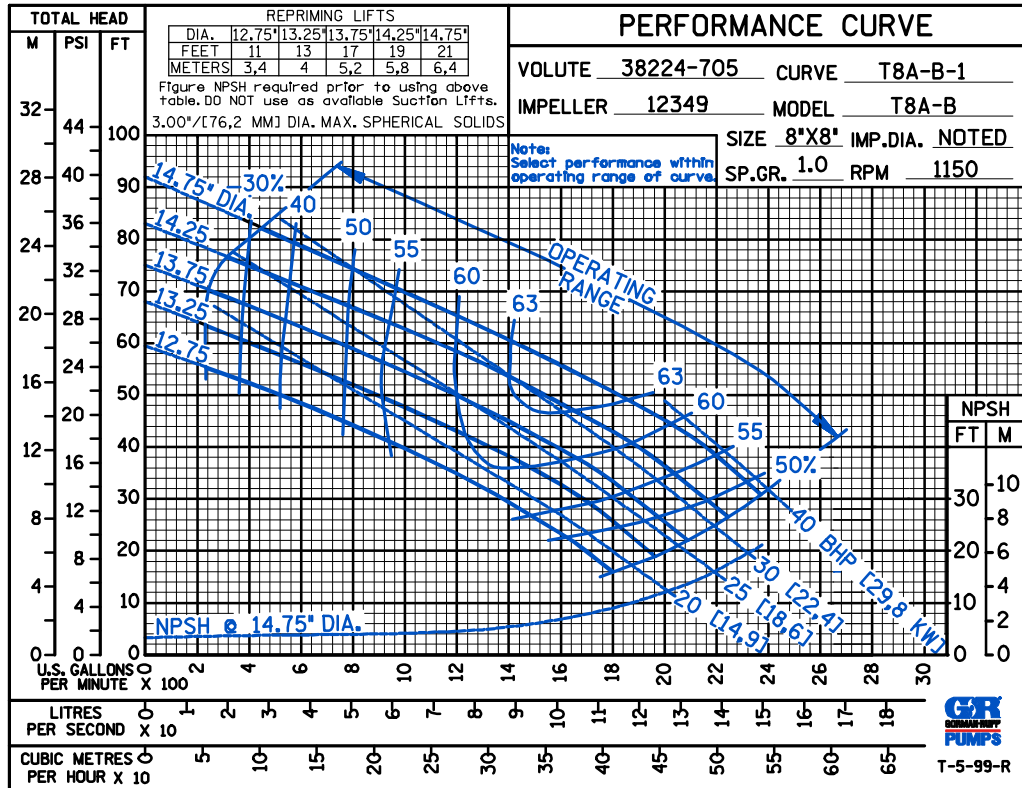

THE GORMAN-RUPP COMPANY • MANSFIELD, OHIO

GORMAN-RUPP OF CANADA LIMITED • ST. THOMAS, ONTARIO, CANADA

Specifications Subject to Change Without Notice

Printed in U.S.A.

CDS

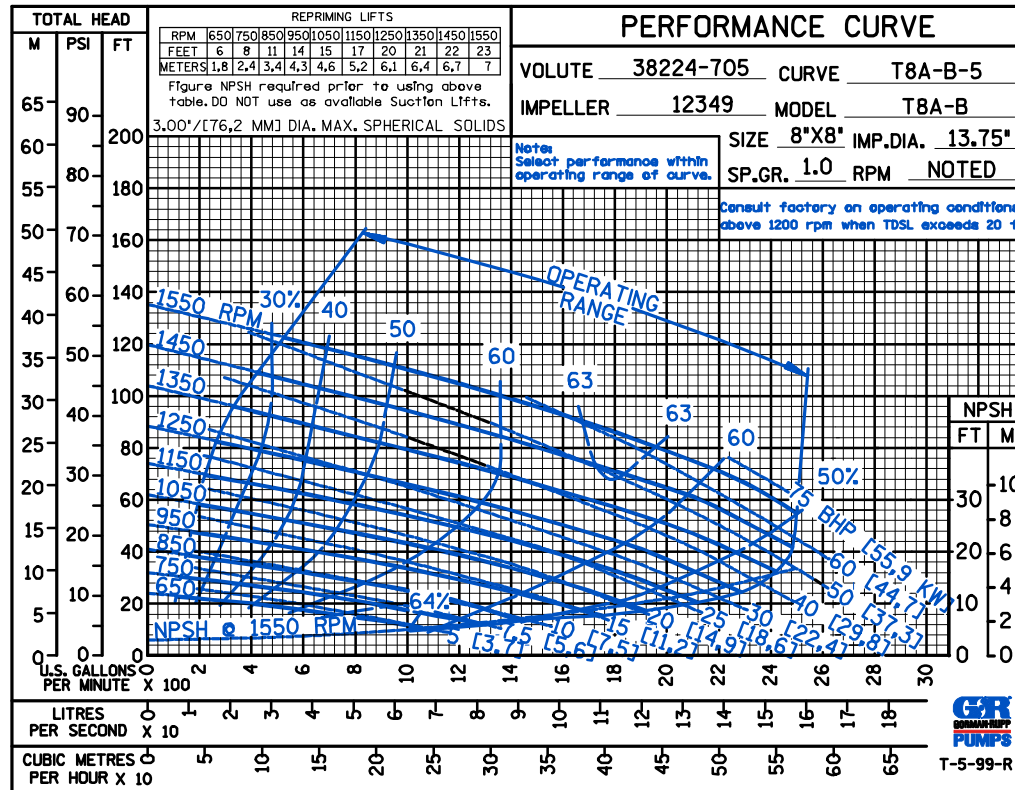
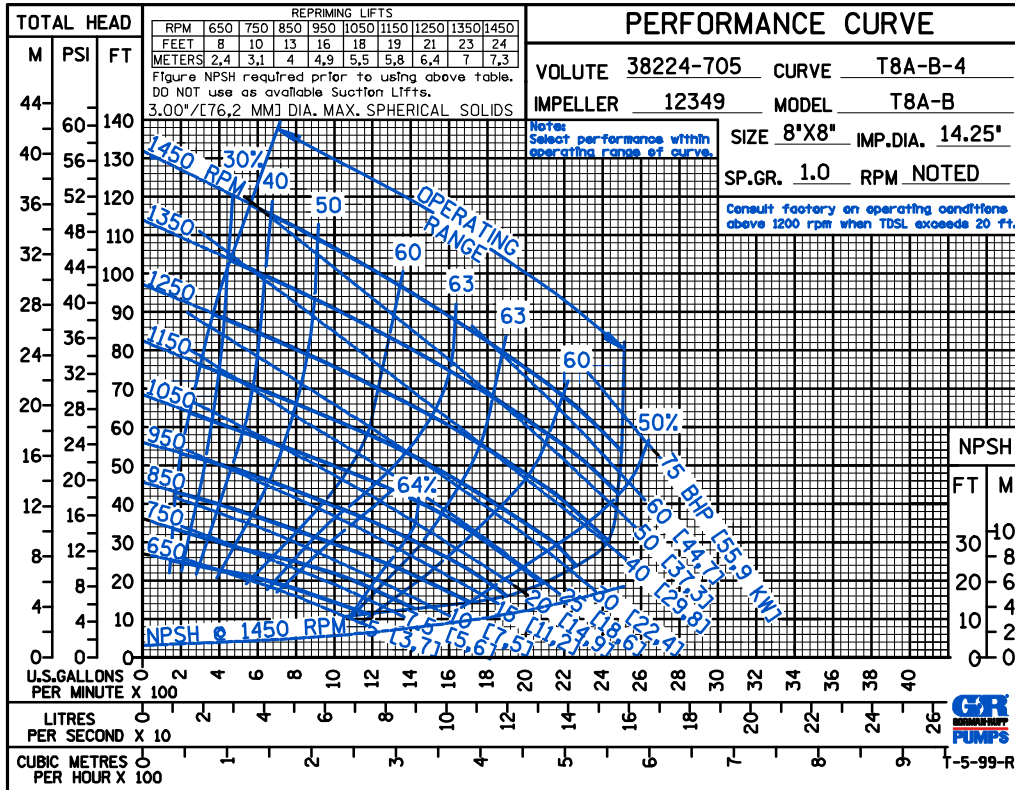

THE GORMAN-RUPP COMPANY • MANSFIELD, OHIO

GORMAN-RUPP OF CANADA LIMITED • ST. THOMAS, ONTARIO, CANADA

Specifications Subject to Change Without Notice

Printed in U.S.A.

CDS

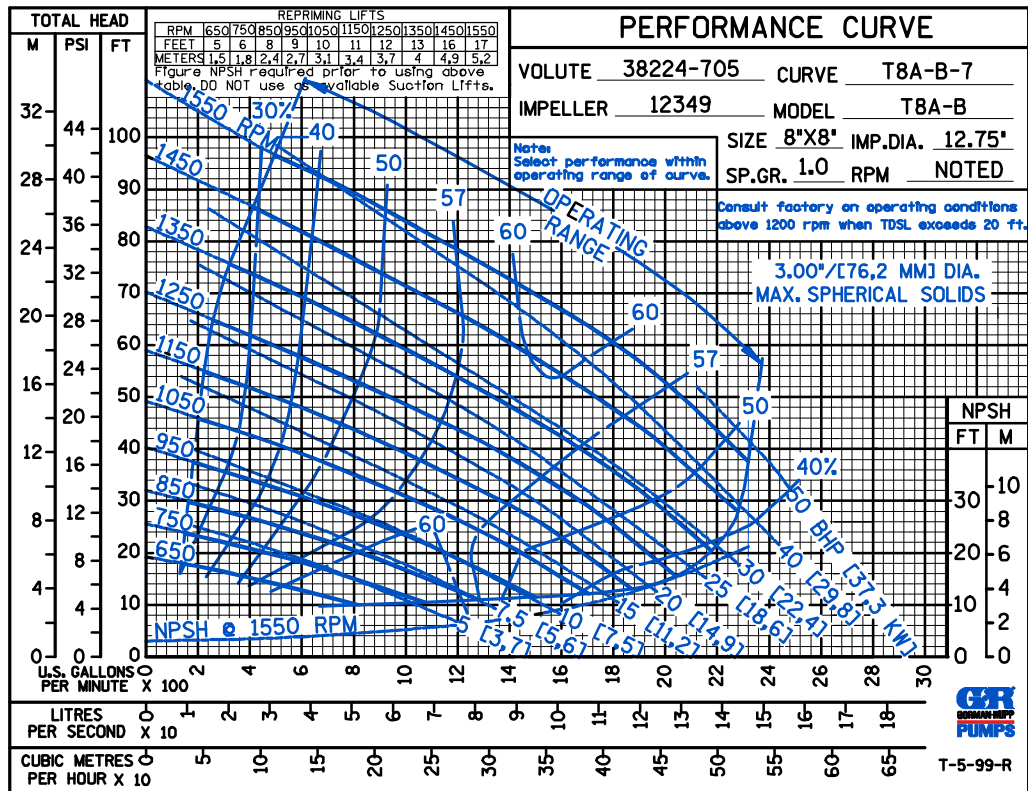
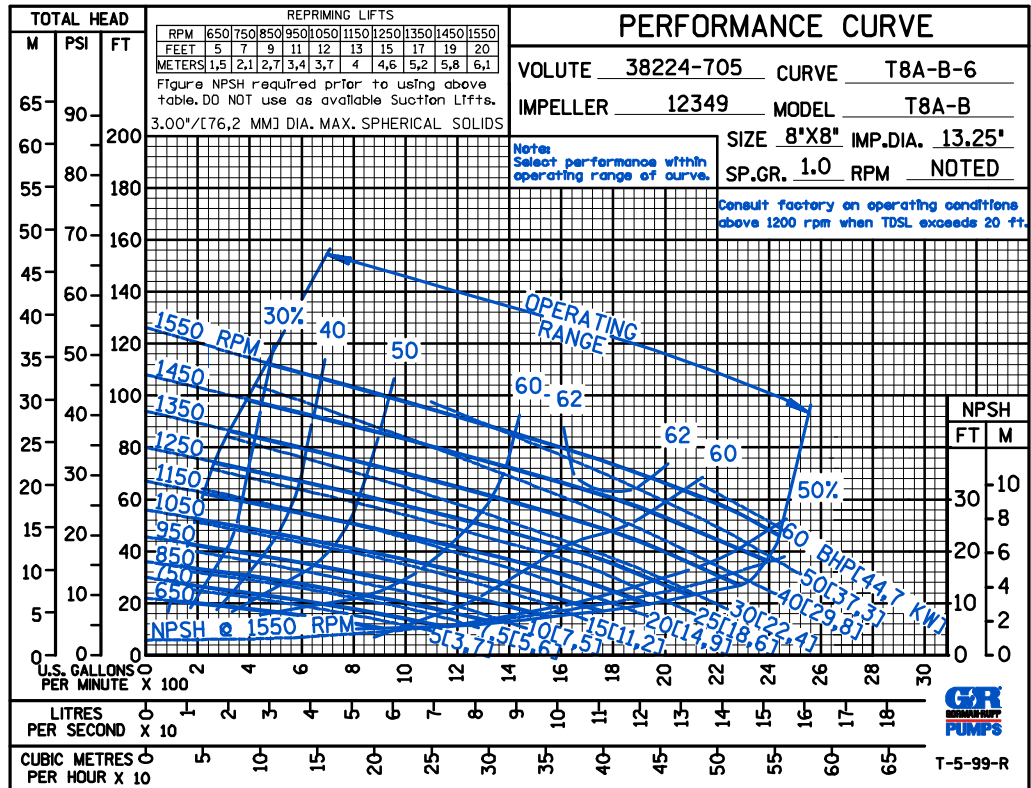

THE GORMAN-RUPP COMPANY • MANSFIELD, OHIO

GORMAN-RUPP OF CANADA LIMITED • ST. THOMAS, ONTARIO, CANADA

Specifications Subject to Change Without Notice

Printed in U.S.A.

CDS

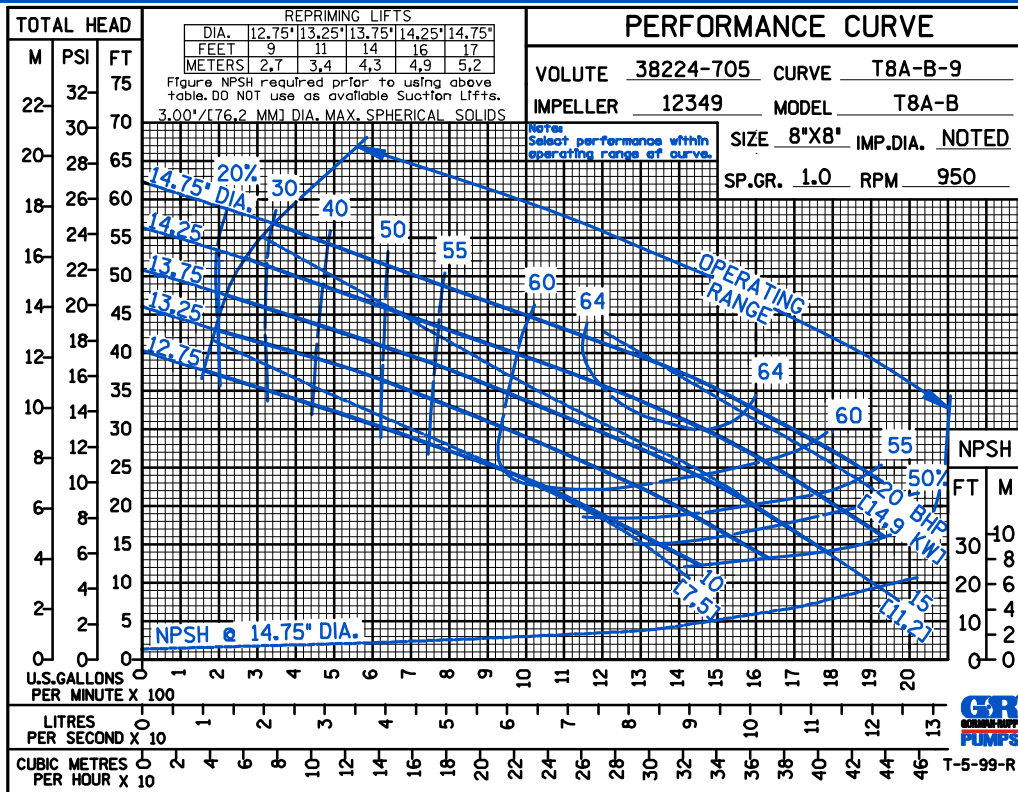
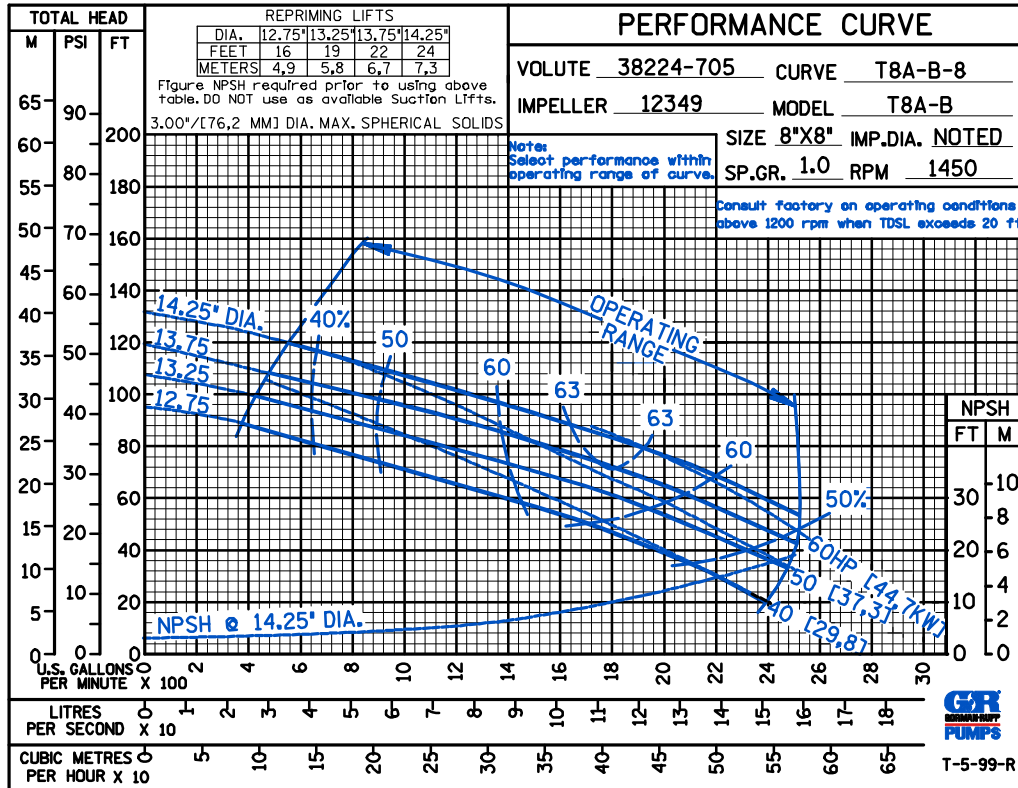

THE GORMAN-RUPP COMPANY • MANSFIELD, OHIO

GORMAN-RUPP OF CANADA LIMITED • ST. THOMAS, ONTARIO, CANADA

Specifications Subject to Change Without Notice

Printed in U.S.A.

CDS

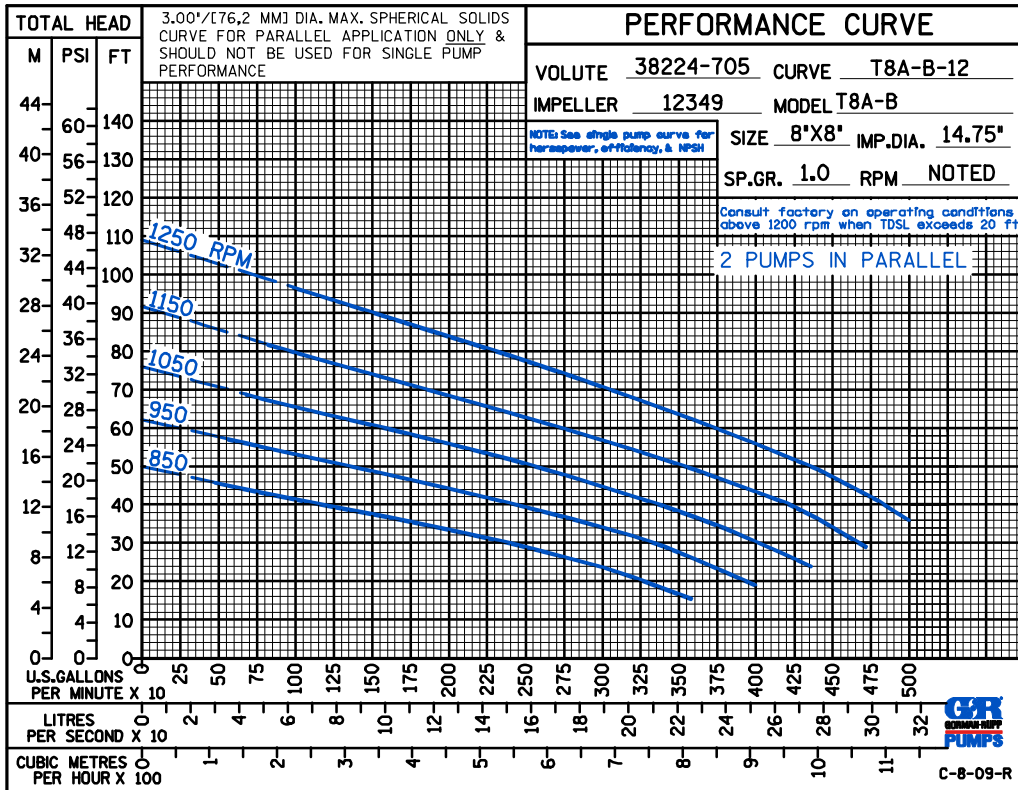
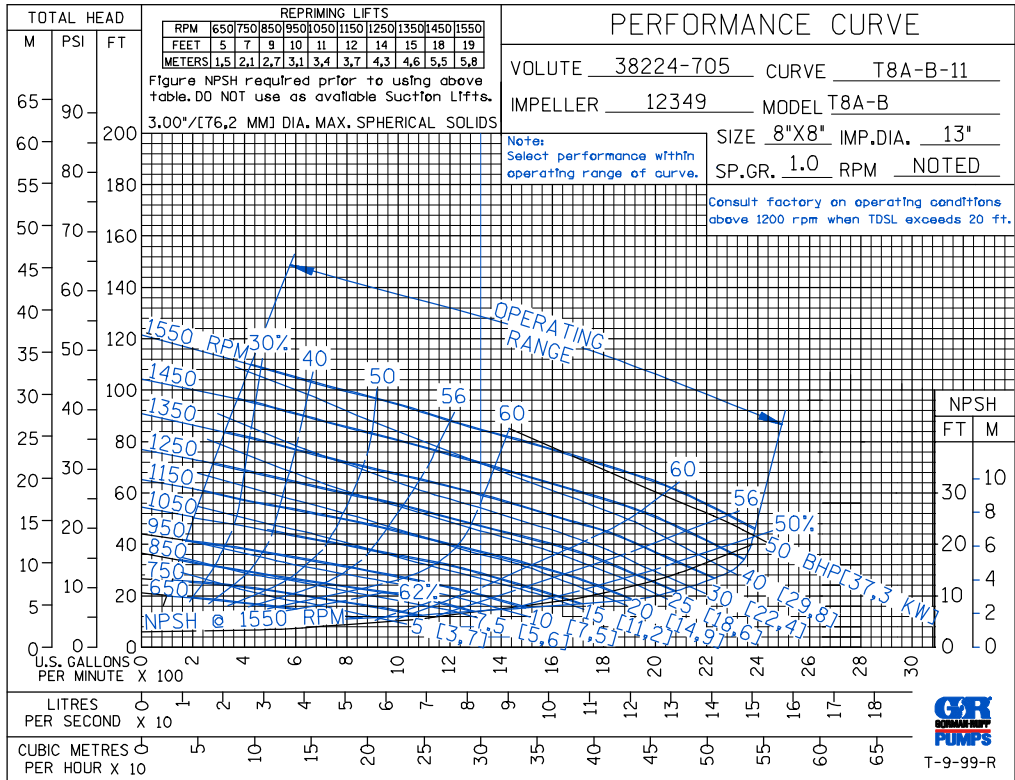

THE GORMAN-RUPP COMPANY • MANSFIELD, OHIO

GORMAN-RUPP OF CANADA LIMITED • ST. THOMAS, ONTARIO, CANADA

Specifications Subject to Change Without Notice

Printed in U.S.A.

D S

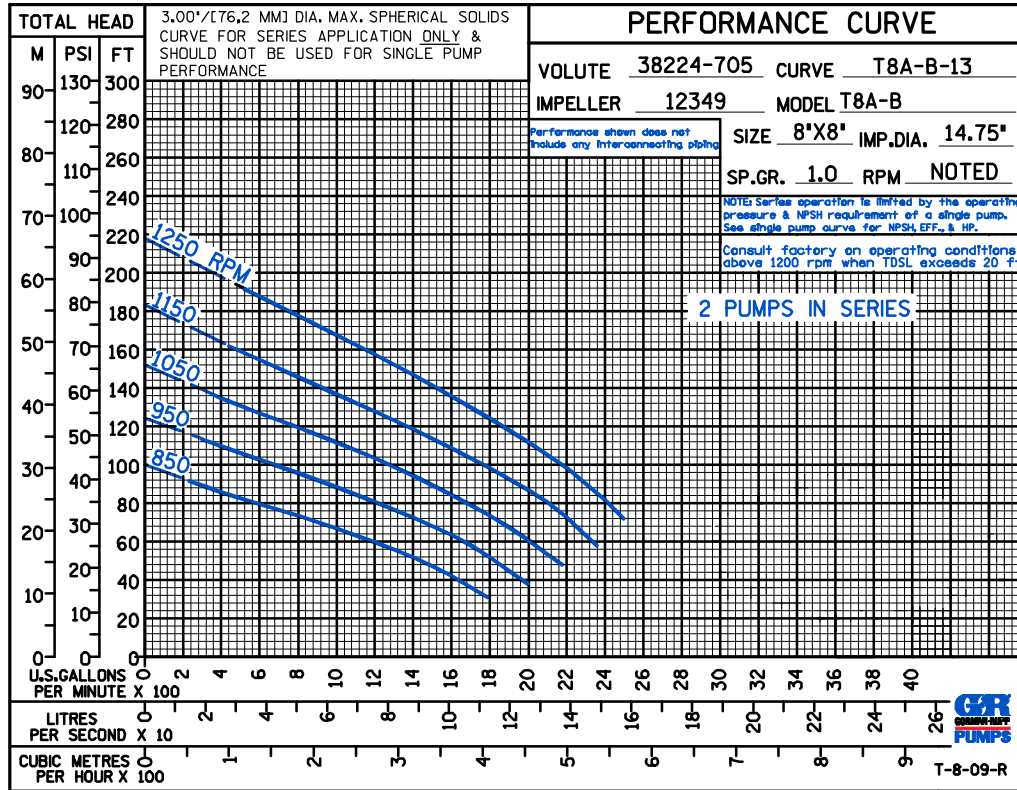

THE GORMAN-RUPP COMPANY • MANSFIELD, OHIO

GORMAN-RUPP OF CANADA LIMITED • ST. THOMAS, ONTARIO, CANADA

Specifications Subject to Change Without Notice

Printed in U.S.A.