

Self Priming Centrifugal Pump

Model T8A60S-B

Size 8" x 8"

Super
T SERIES

VARIOUS PATENTS APPLY



PUMP SPECIFICATIONS

Size: 8" (203 mm) ASA Flanged Suction x 8" (203 mm) NPT Female Discharge.

Casing: Gray Iron 30.

Maximum Operating Pressure 83 psi (572 kPa).*

Semi-Open Type, Two Vane Impeller: Ductile Iron 65-45-12.

Handles 3" (76,2 mm) Diameter Spherical Solids.

Impeller Shaft: Alloy Steel 4150.

Shaft Sleeve: Alloy Steel 4130.

Replaceable Wear Plate: Gray Iron 30.

Removable Adjustable Cover Plate: Gray Iron 30.

Removable Inspection Cover Plate: Gray Iron 30; 20 lbs. (9,1 kg.).

Flap Valve: Neoprene w/Nylon and Steel Reinforcing.

Seal Plate: Gray Iron 30.

Bearing Housing: Gray Iron 30.

Radial and Thrust Bearings: Open Double Row Ball.

Bearing and Seal Cavity Lubrication: SAE 30 Non-Detergent Oil.

Flanges: Gray Iron 30.

Gaskets: Buna-N, Compressed Synthetic Fibers, PTFE, Cork, and Rubber.

O-Rings: Buna-N.

Hardware: Standard Plated Steel.

Brass Pressure Relief Valve.

Bearing and Seal Cavity Oil Level Sight Gauges.

Optional Equipment: Metal Bellows Seal. Automatic Air Release Valve. 120V/240V Casing Heater. High Pump Temperature Shutdown Kit.

Gray Iron 30 Spool Flanges:

8" ASA Discharge (**Specify Model T8A60S-B /F**).

200 mm DIN 2527 (PN 16) Suction and Discharge

(**Specify Model T8A60S-B /FM**).

**Consult Factory for Applications Exceeding Maximum Pressure and/or Temperature Indicated.*



Shown with Optional Discharge Spool Flange (Available in ASA or DIN Standard Sizes).

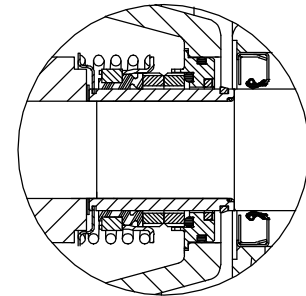
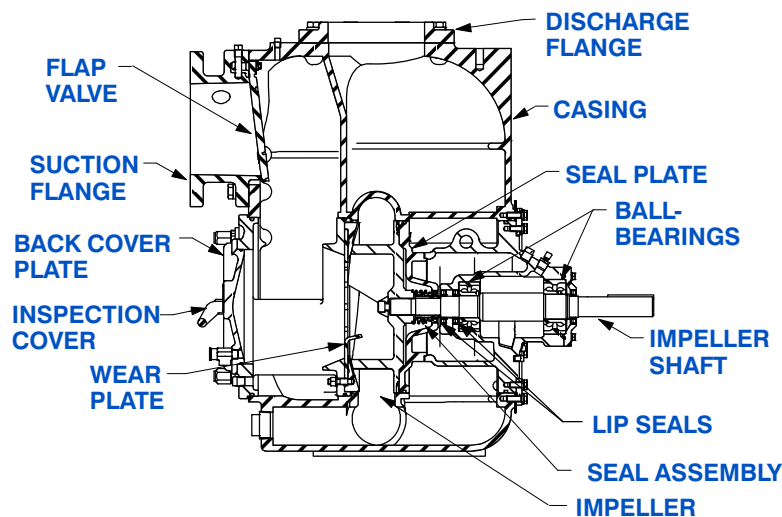

SEAL SPECIFICATIONS

Cartridge Type, Mechanical, Oil-Lubricated, Double Floating, Self-Aligning. Silicon Carbide Rotating and Stationary Faces. Stainless Steel 316 Stationary Seat. Fluorocarbon Elastomers (DuPont Viton® or Equivalent). Stainless Steel 18-8 Cage and Spring. Maximum Temperature of Liquid Pumped, 160°F (71°C).*



GORMAN-RUPP PUMPS

www.grpumps.com

Specifications Subject to Change Without Notice

Printed in U.S.A.

Specification Data

SECTION 55, PAGE 2310C

APPROXIMATE DIMENSIONS and WEIGHTS

NET WEIGHT: 1295 LBS. (587 KG.)*
SHIPPING WEIGHT: 1399 LBS. (635 KG.)*
EXPORT CRATE: 47.9 CU. FT. (1,36 CU. M.)
***ADD 35 LBS. (15,9 KG.) W/EACH SPOOL FLANGE**

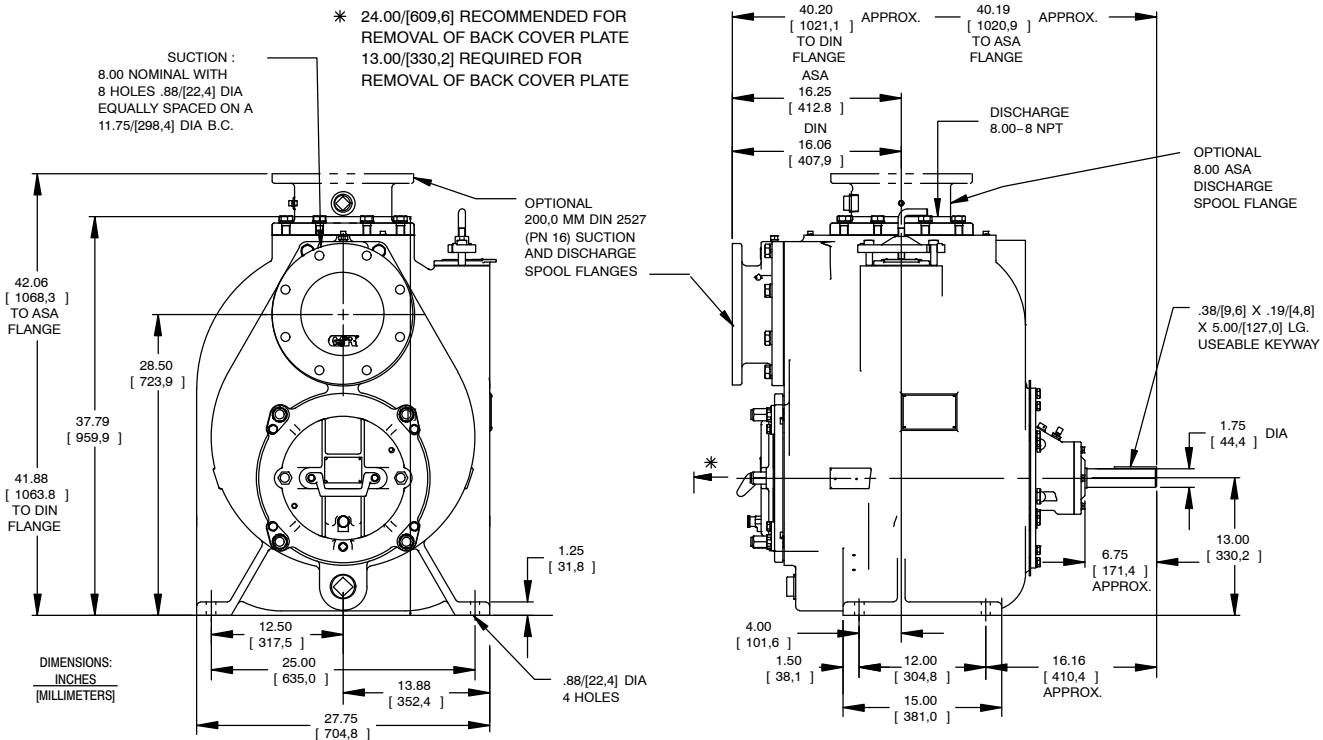

OPTIONAL ASA OR DIN STANDARD SPOOL FLANGES AVAILABLE

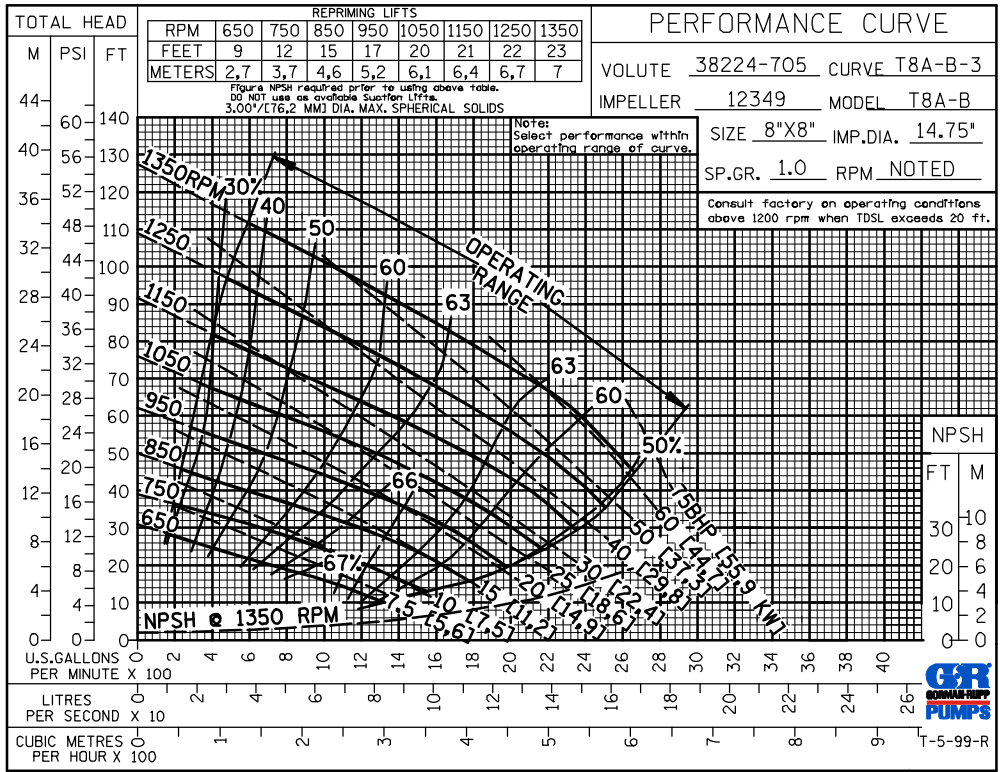

GORMAN-RUPP PUMPS

www.grpumps.com

Specifications Subject to Change Without Notice

Printed in U.S.A.

CDS

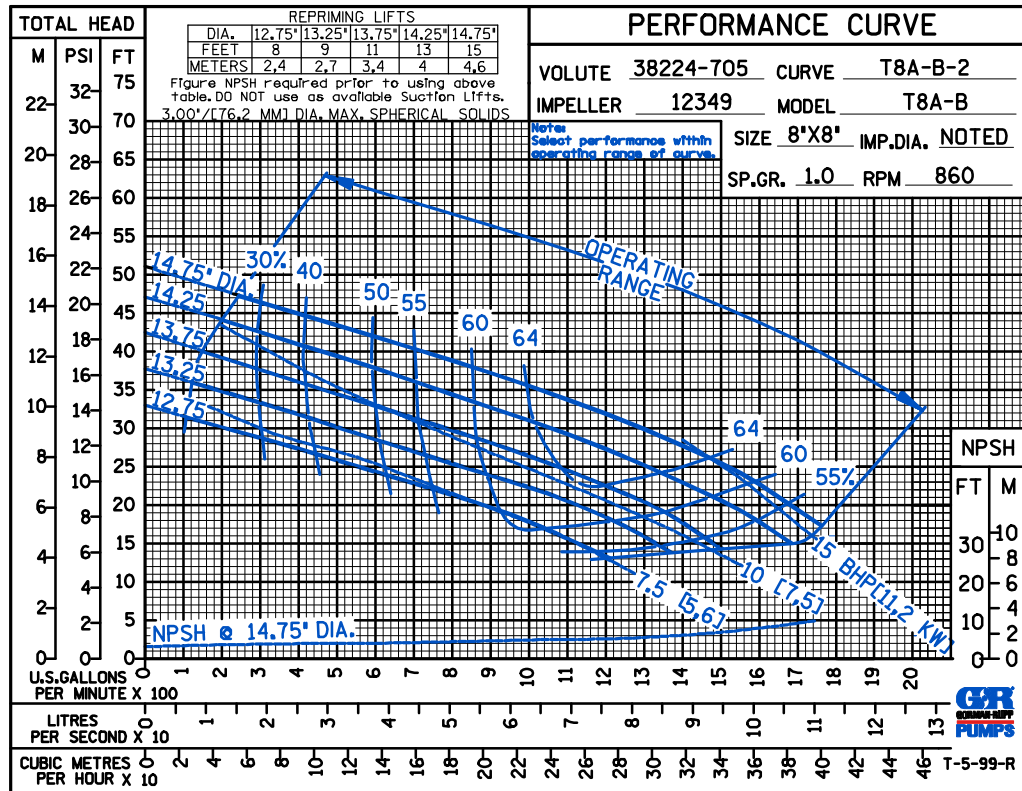
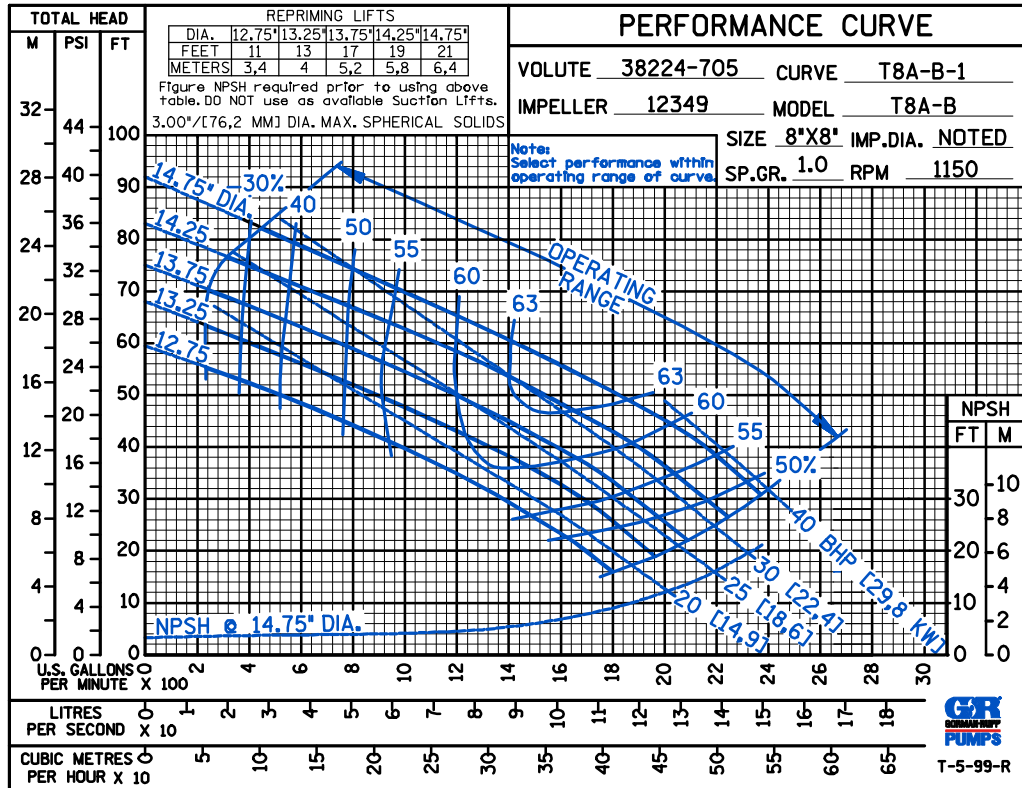

THE GORMAN-RUPP COMPANY • MANSFIELD, OHIO

GORMAN-RUPP OF CANADA LIMITED • ST. THOMAS, ONTARIO, CANADA

Specifications Subject to Change Without Notice

Printed in U.S.A.

CDS

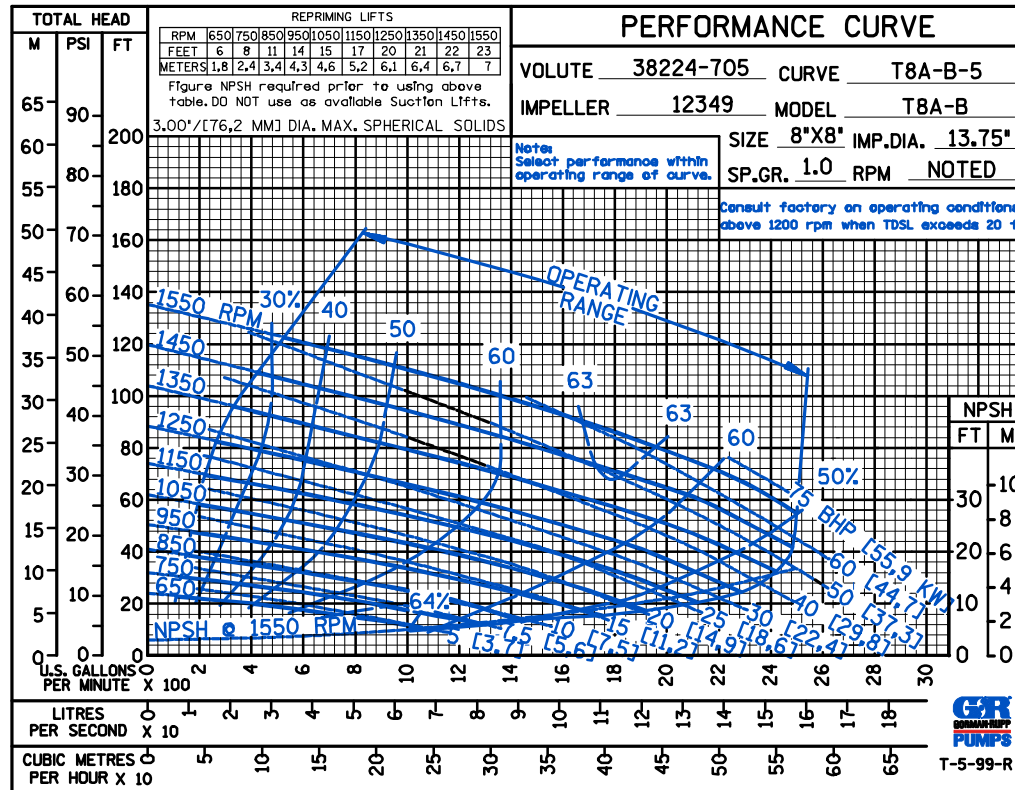
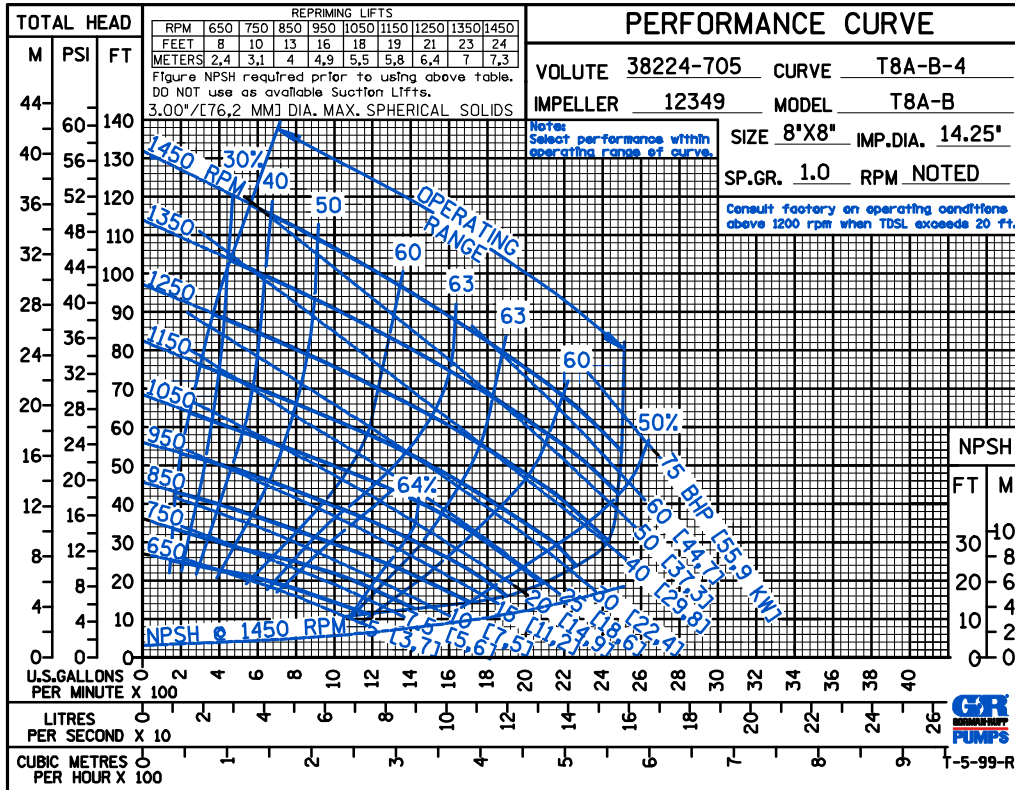

THE GORMAN-RUPP COMPANY • MANSFIELD, OHIO

GORMAN-RUPP OF CANADA LIMITED • ST. THOMAS, ONTARIO, CANADA

Specifications Subject to Change Without Notice

Printed in U.S.A.

CDS

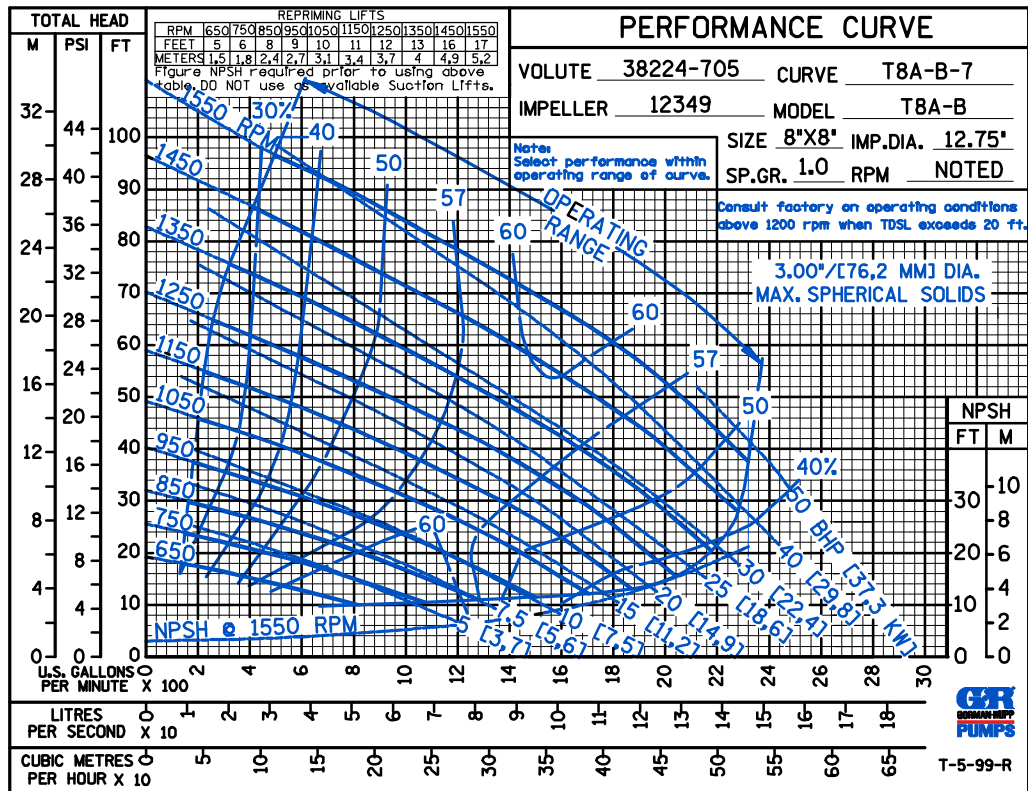
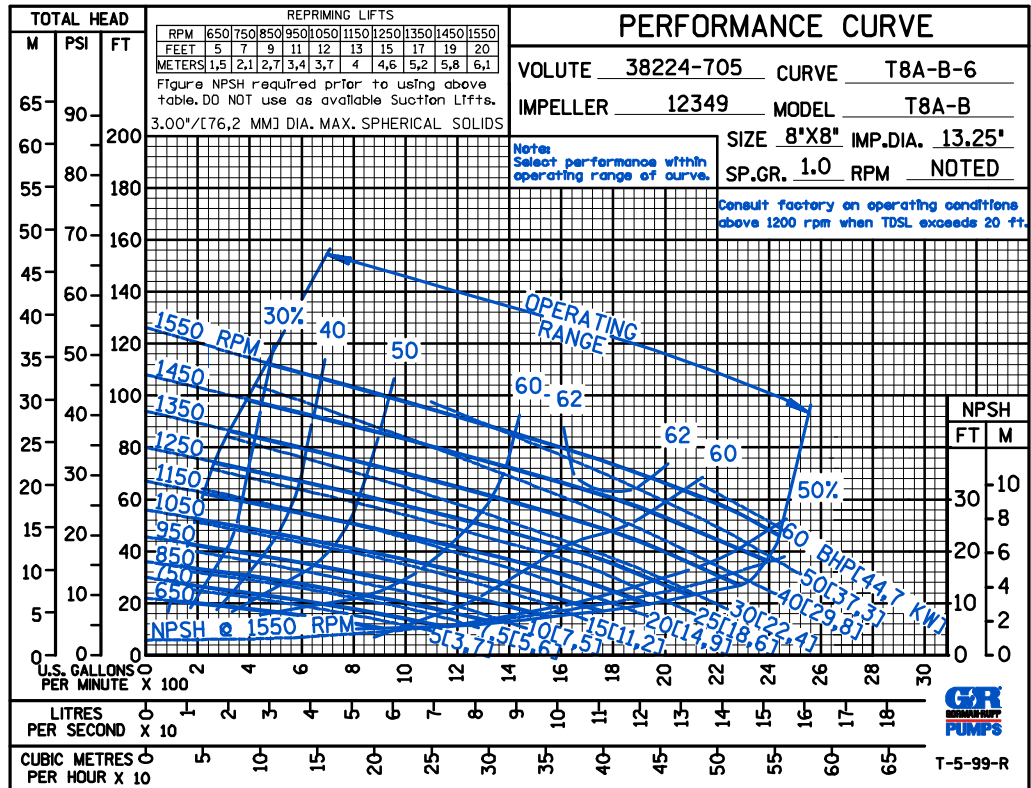

THE GORMAN-RUPP COMPANY • MANSFIELD, OHIO

GORMAN-RUPP OF CANADA LIMITED • ST. THOMAS, ONTARIO, CANADA

Specifications Subject to Change Without Notice

Printed in U.S.A.

CDS

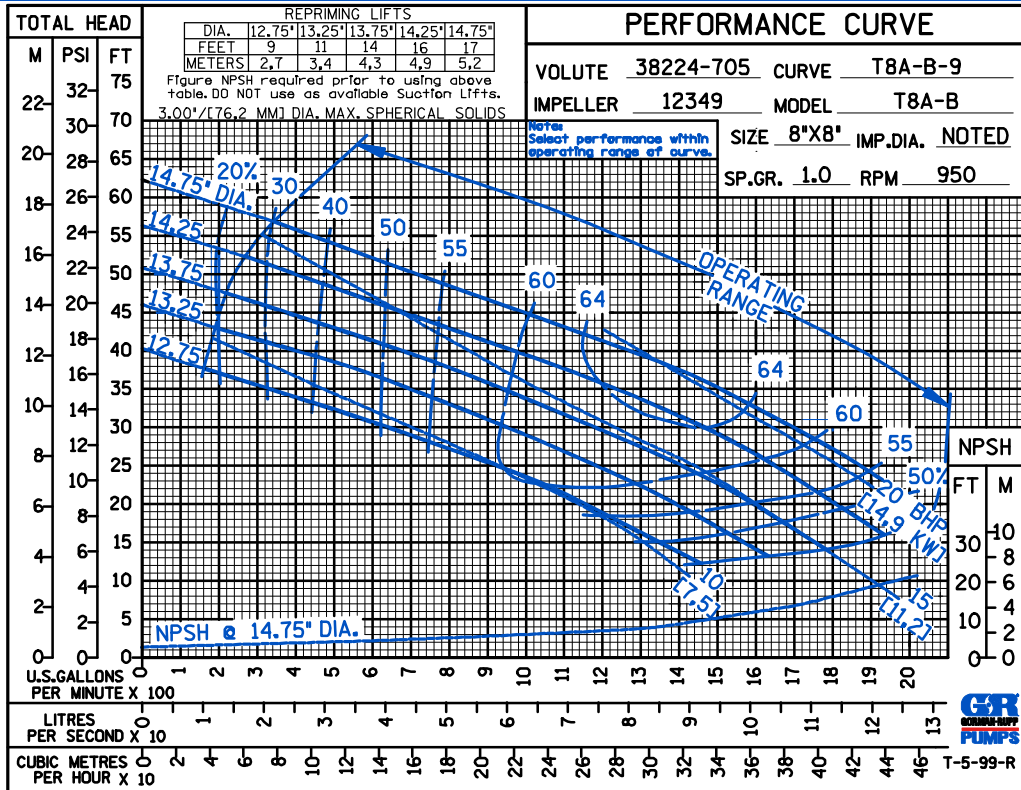
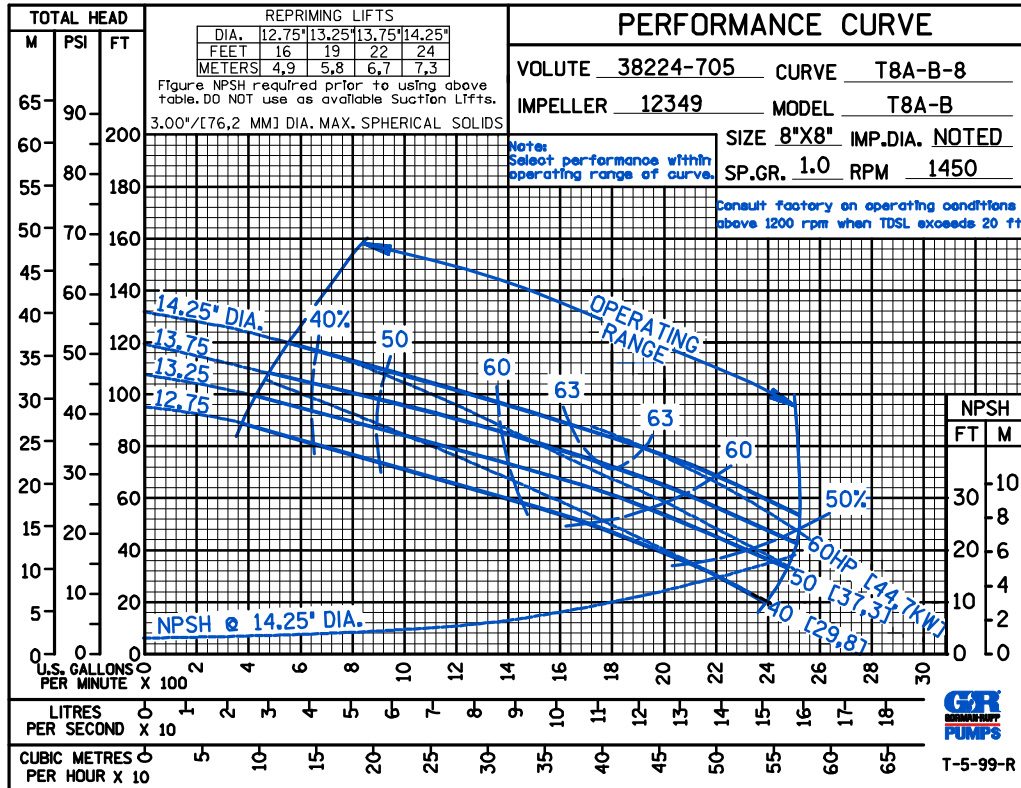

THE GORMAN-RUPP COMPANY • MANSFIELD, OHIO

GORMAN-RUPP OF CANADA LIMITED • ST. THOMAS, ONTARIO, CANADA

Specifications Subject to Change Without Notice

Printed in U.S.A.

CDS

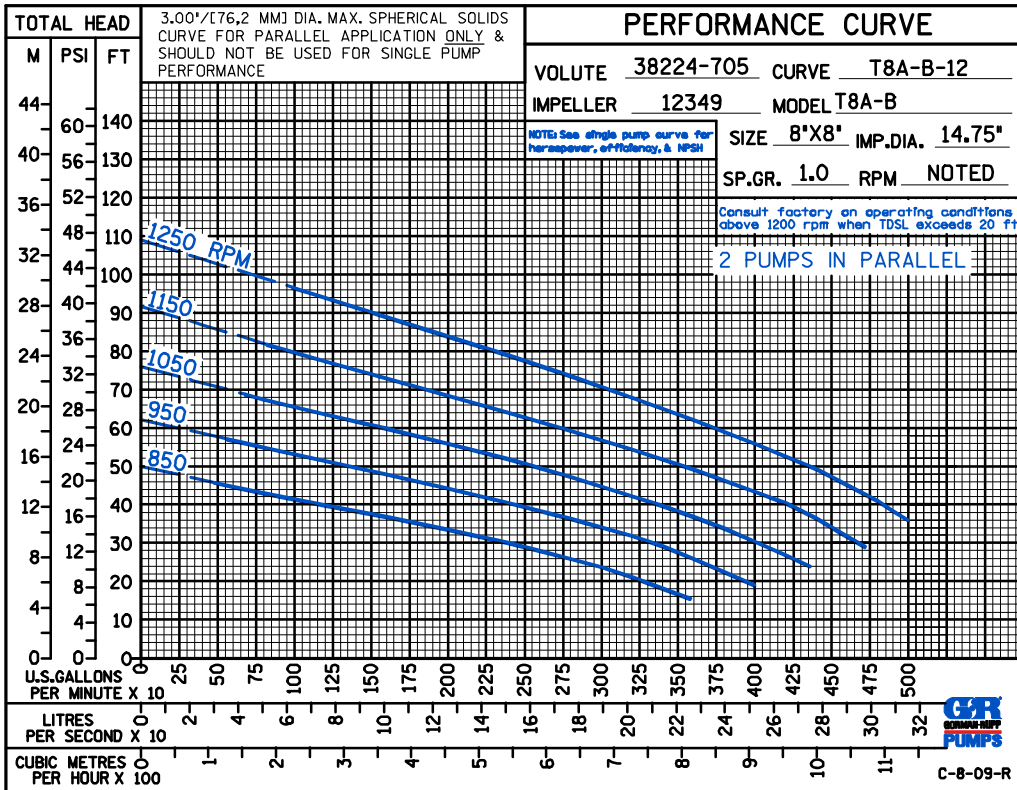
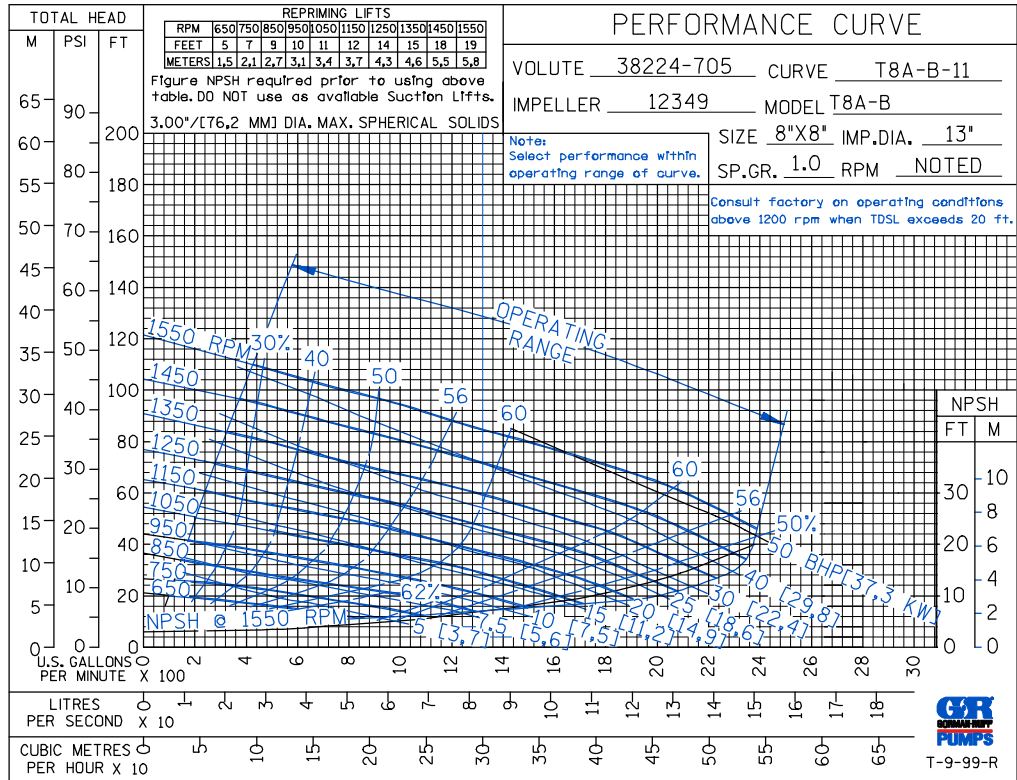

THE GORMAN-RUPP COMPANY • MANSFIELD, OHIO

GORMAN-RUPP OF CANADA LIMITED • ST. THOMAS, ONTARIO, CANADA

Specifications Subject to Change Without Notice

Printed in U.S.A.

D S

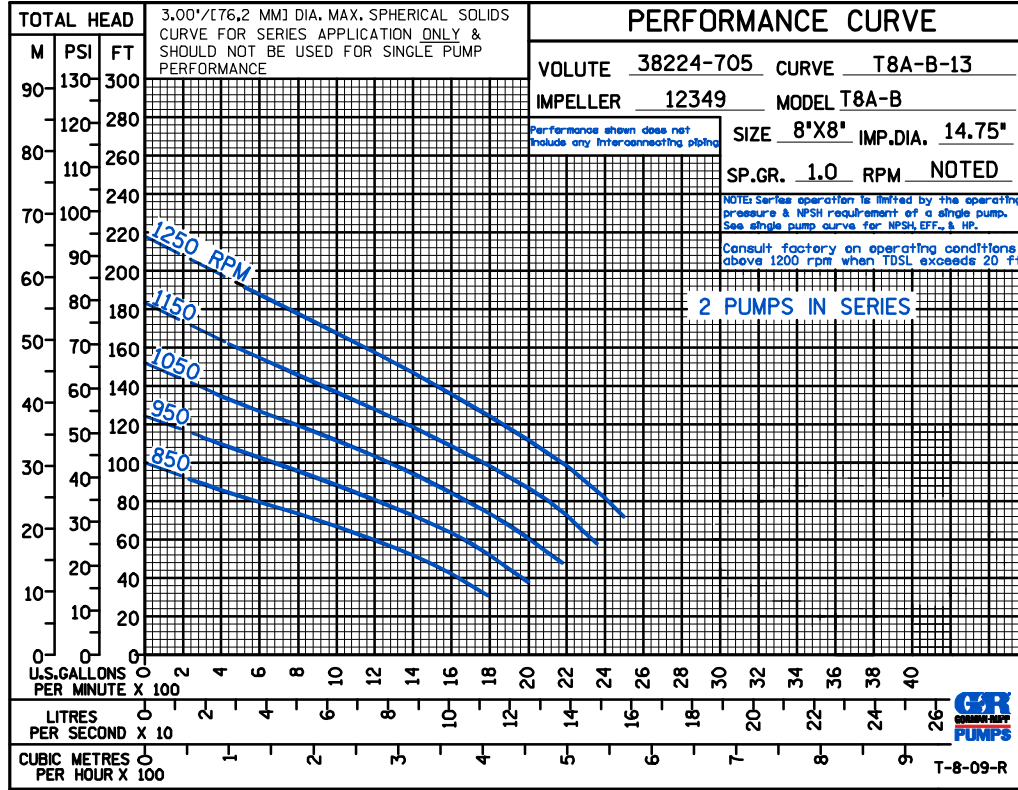

THE GORMAN-RUPP COMPANY • MANSFIELD, OHIO

GORMAN-RUPP OF CANADA LIMITED • ST. THOMAS, ONTARIO, CANADA

Specifications Subject to Change Without Notice

Printed in U.S.A.