

## G-R Hard Iron Fitted Basic Pump

## Self Priming Centrifugal Pump

*Super*  
**TSERIES**

VARIOUS PATENTS APPLY

Model T6A71S-B

Size 6" x 6"



## PUMP SPECIFICATIONS

**Size:** 6" x 6" (152 mm x 152 mm) NPT - Female.**Casing:** Gray Iron 30.

Maximum Operating Pressure 79 psi (545 kPa).\*

**Semi-Open Type, Two Vane Impeller:** G-R Hard Iron.

Handles 3" (76,2 mm) Diameter Spherical Solids.

**Impeller Shaft:** Alloy Steel 4150.**Shaft Sleeve:** Alloy Steel 4130.**Replaceable Wear Plate:** Hardened Alloy Steel.**Removable Adjustable Cover Plate:** Gray Iron 30; 62 lbs. (28 kg).**Flap Valve:** Neoprene <sup>w</sup>/Nylon and Steel Reinforcing.**Seal Plate:** G-R Hard Iron.**Bearing Housing:** Gray Iron 30.**Radial Bearing:** Open Single Row Ball.**Thrust Bearing:** Open Double Row Ball.**Bearing and Seal Cavity Lubrication:** SAE 30 Non-Detergent Oil.**Flanges:** Gray Iron 30.**Gaskets:** Buna-N, Compressed Synthetic Fibers, PTFE, Vegetable Fiber, Cork, and Rubber.**O-Rings:** Buna-N.**Hardware:** Standard Plated Steel.**Brass Pressure Relief Valve.****Bearing and Seal Cavity Oil Level Sight Gauges.****Optional Equipment:** Metal Bellows Seal. Automatic Air

Release Valve. 120V/240V Casing Heater. High Pump

Temperature Shutdown Kit. G-R Hard Iron Casing.

High Chrome Cast Iron Impeller.

Gray Iron 30 Suction and Discharge Spool Flanges:

6" ASA (Specify Model T6A71S-B /F).

150 mm DIN 2527 (PN16) (Specify Model T6A71S-B /FM).

*\*Consult Factory for Applications Exceeding**Maximum Pressure and/or Temperature Indicated.*

Shown with Optional Suction & Discharge Spool Flanges (Available in ASA or DIN Standard Sizes).

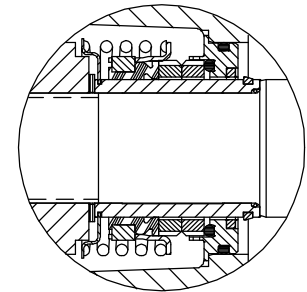
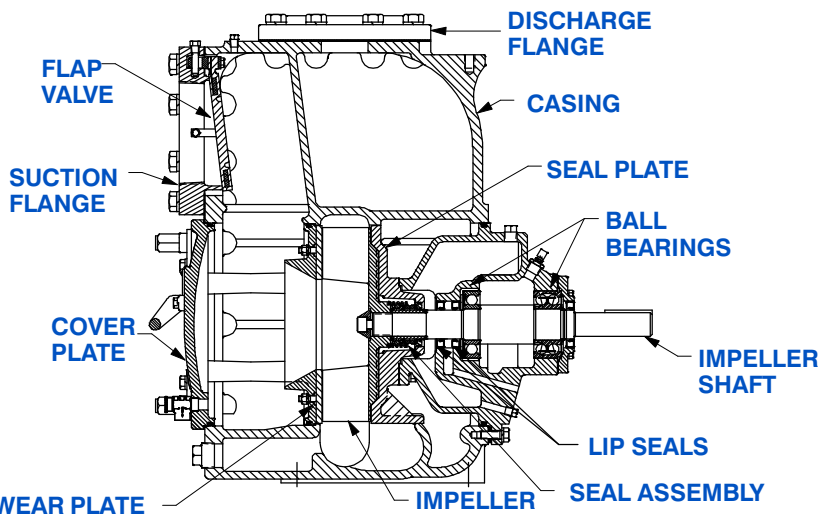

## SEAL DETAIL

Cartridge Type, Mechanical, Oil-Lubricated, Double Floating, Self-Aligning. Silicon Carbide Rotating and Stationary Faces. Stainless Steel 316 Stationary Seat. Fluorocarbon Elastomers (DuPont Viton<sup>®</sup> or Equivalent). Stainless Steel 18-8 Cage and Spring. Maximum Temperature of Liquid Pumped, 160°F (71°C).\*

**G-R**  
GORMAN-RUPP  
PUMPS

GORMAN-RUPP PUMPS

www.grpumps.com

Specifications Subject to Change Without Notice

Printed in U.S.A.

**Specification Data**

**APPROXIMATE DIMENSIONS and WEIGHTS**

**NET WEIGHT: 865 LBS. (392 KG.)\***  
**SHIPPING WEIGHT: 920 LBS. (417 KG.)\***  
**EXPORT CRATE: 32.5 CU. FT. (0.92 CU. M.)**  
**\*ADD 25 LBS. (11,3 KG.) W/EACH SPOOL FLANGE**

**SECTION 55, PAGE 2240C**

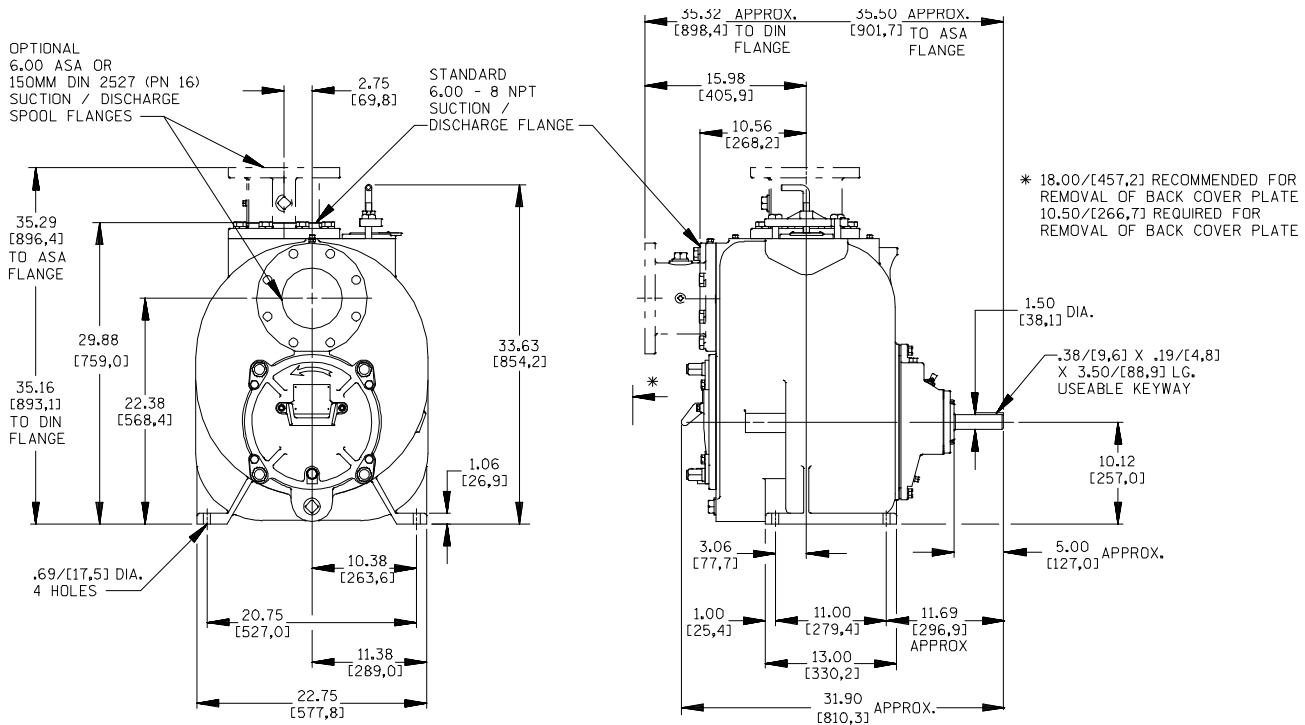

**OPTIONAL ASA OR DIN STANDARD SUCTION & DISCHARGE SPOOL FLANGES AVAILABLE**

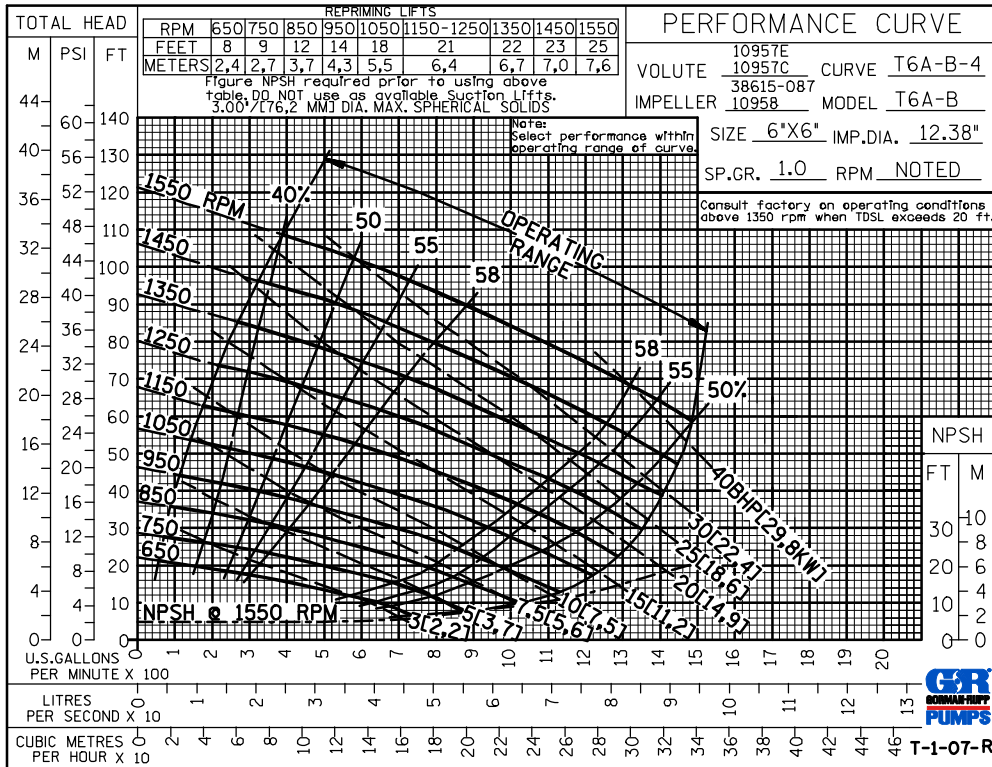

**GORMAN-RUPP PUMPS**

www.grpumps.com

Specifications Subject to Change Without Notice

Printed in U.S.A.

CDS

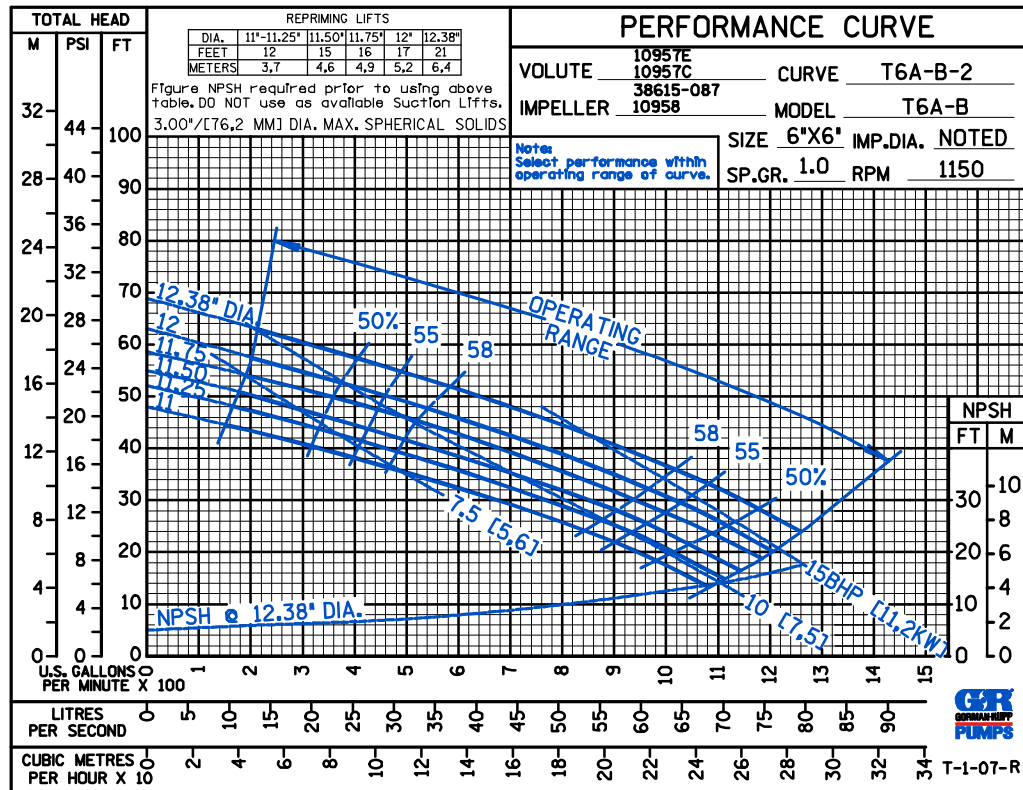
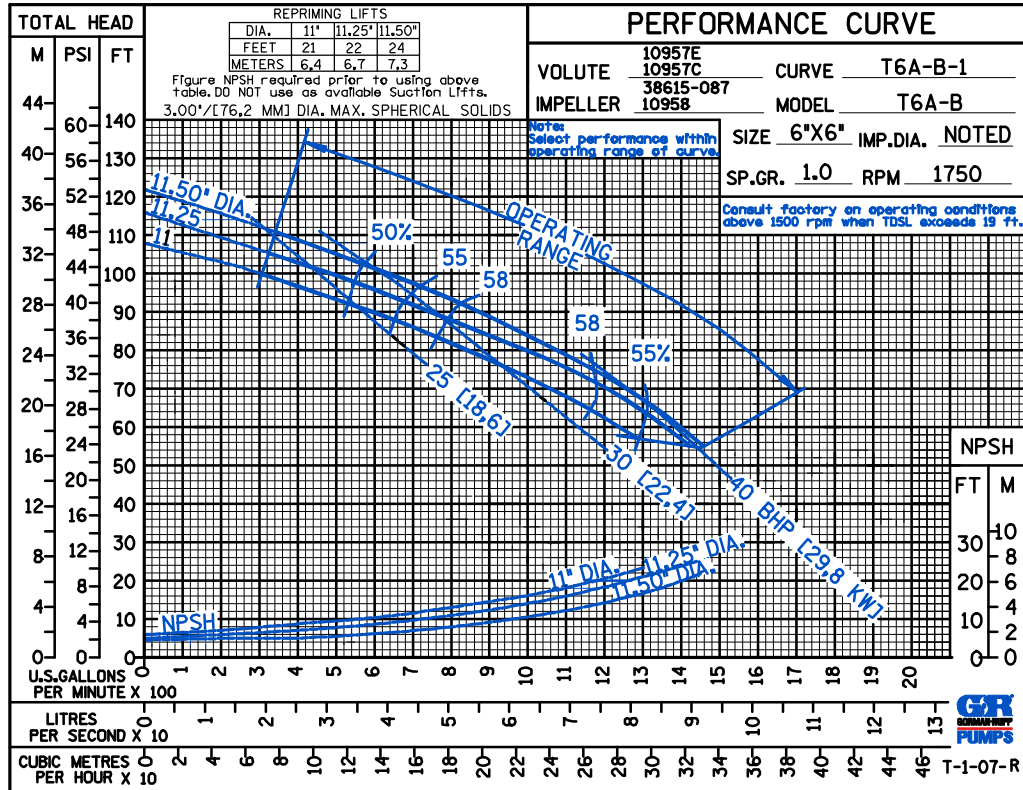

THE GORMAN-RUPP COMPANY • MANSFIELD, OHIO

GORMAN-RUPP OF CANADA LIMITED • ST. THOMAS, ONTARIO, CANADA

Specifications Subject to Change Without Notice

Printed in U.S.A.

CDS

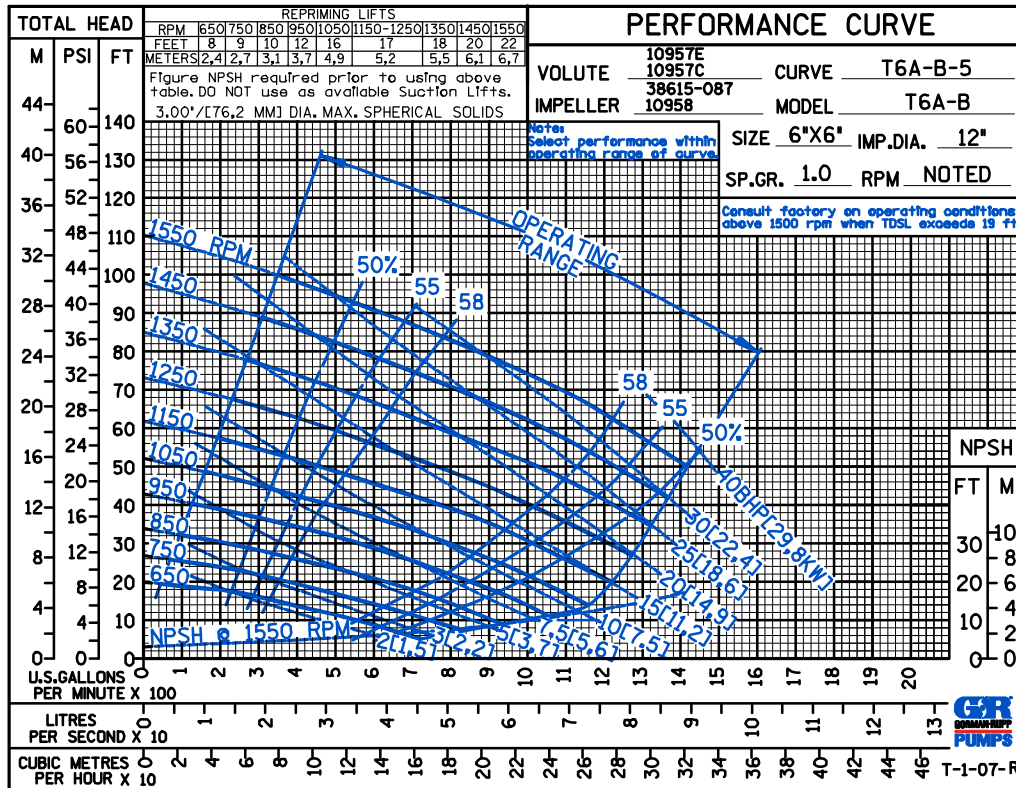
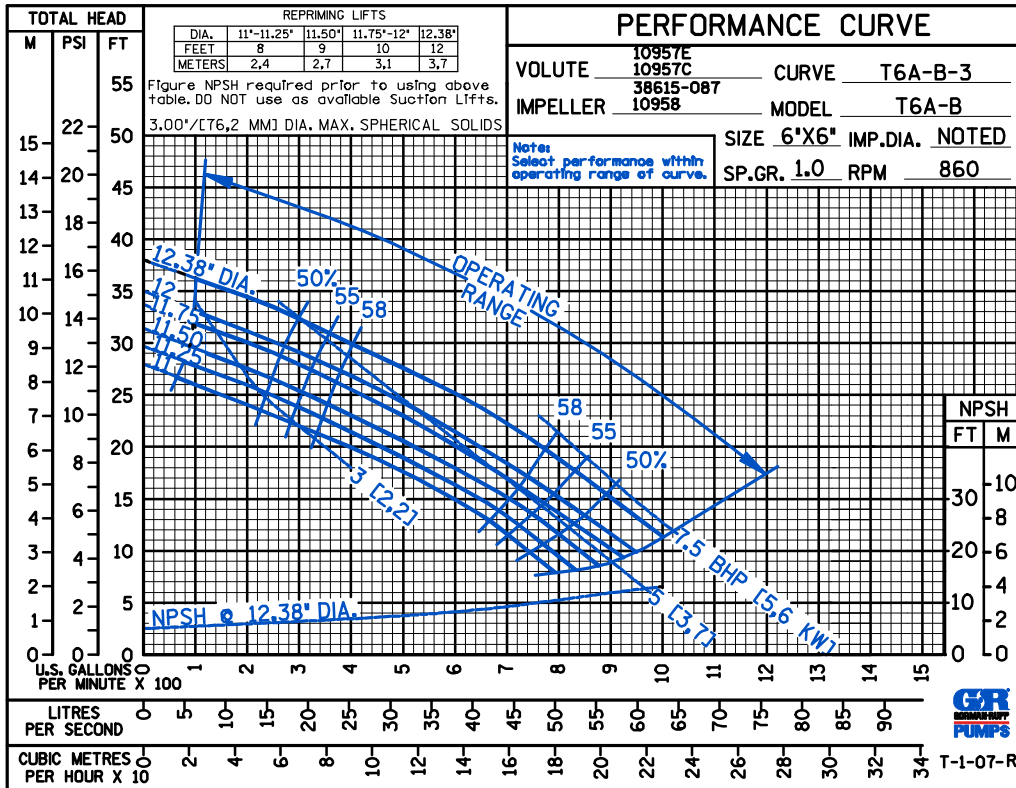

THE GORMAN-RUPP COMPANY • MANSFIELD, OHIO

GORMAN-RUPP OF CANADA LIMITED • ST. THOMAS, ONTARIO, CANADA

Specifications Subject to Change Without Notice

Printed in U.S.A.

CDS

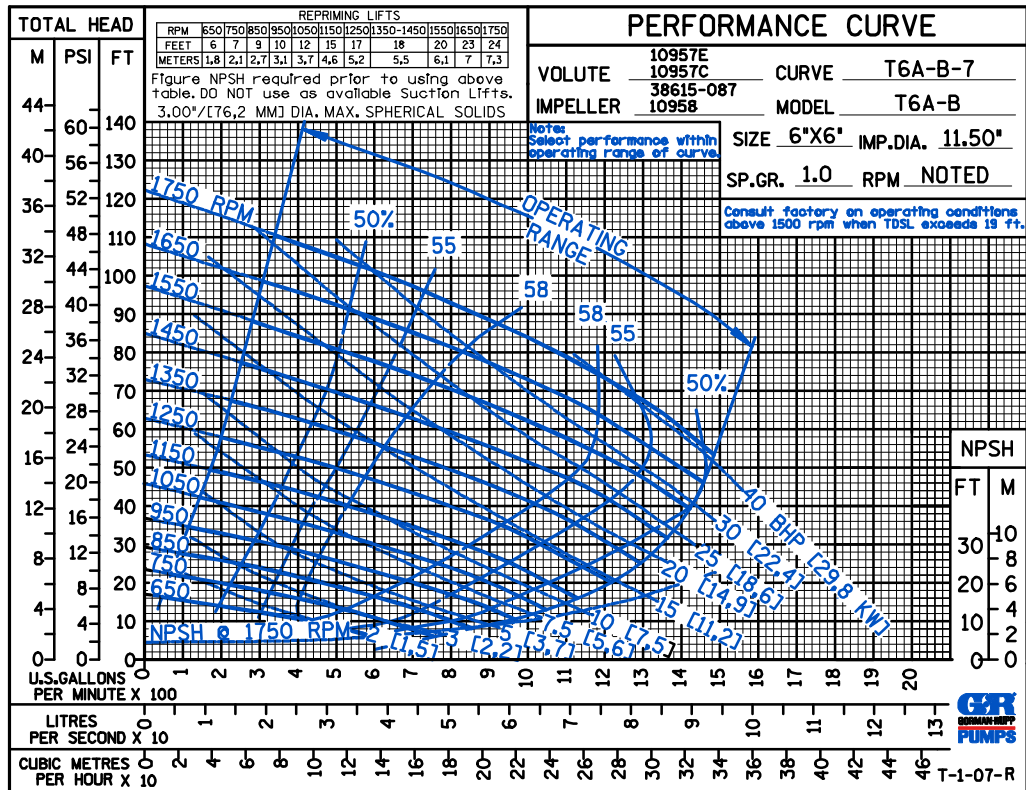
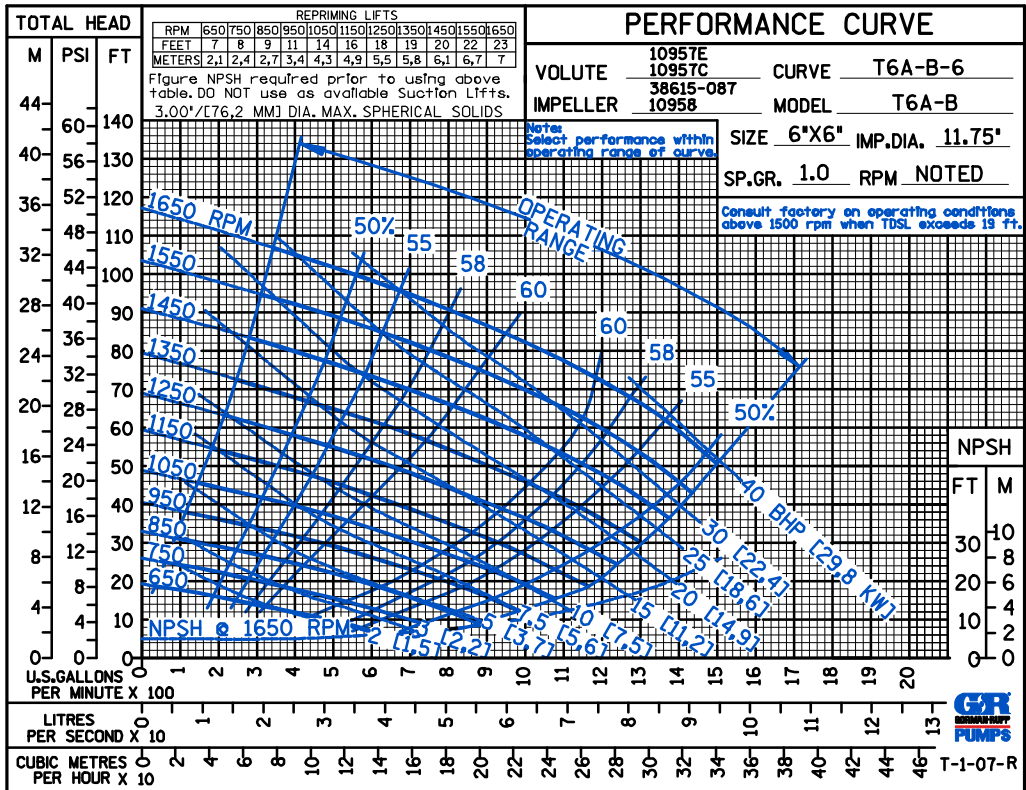

THE GORMAN-RUPP COMPANY • MANSFIELD, OHIO

GORMAN-RUPP OF CANADA LIMITED • ST. THOMAS, ONTARIO, CANADA

Specifications Subject to Change Without Notice

Printed in U.S.A.

CDS

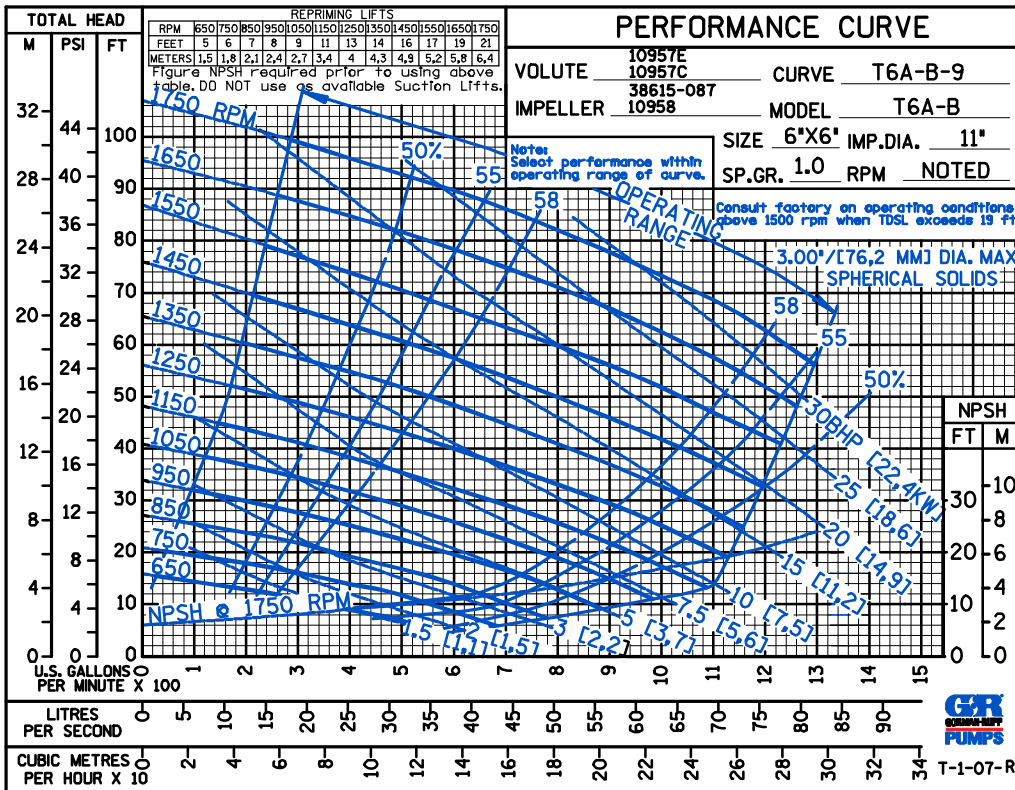
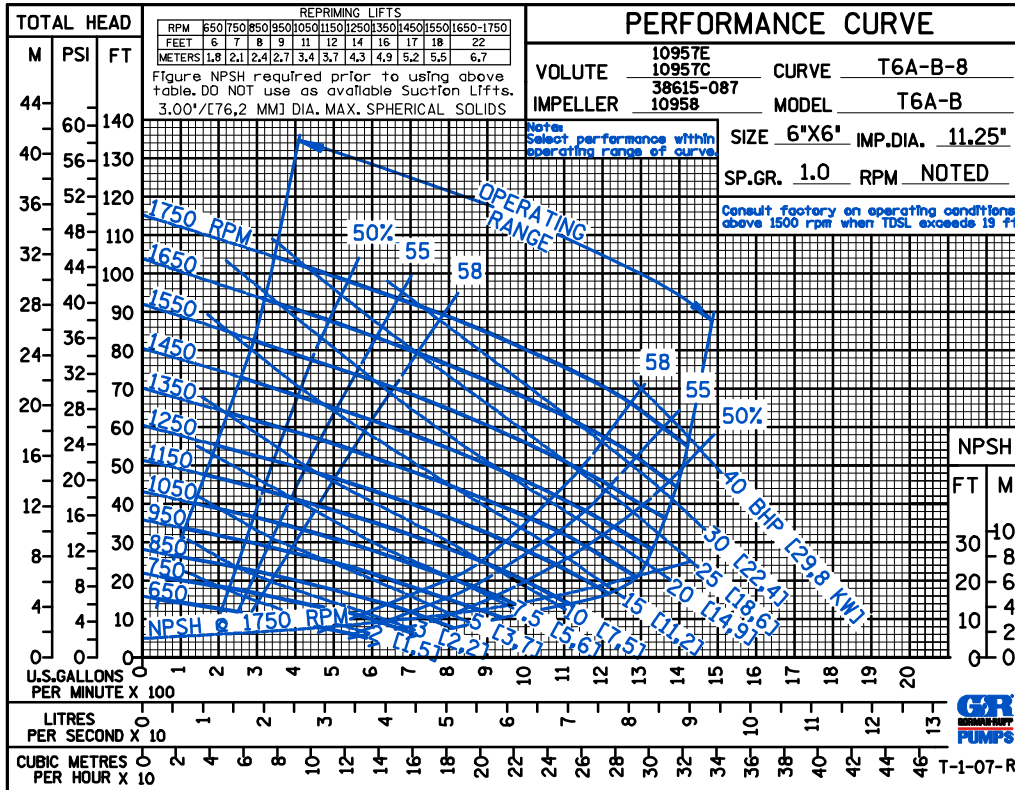

THE GORMAN-RUPP COMPANY • MANSFIELD, OHIO

GORMAN-RUPP OF CANADA LIMITED • ST. THOMAS, ONTARIO, CANADA

Specifications Subject to Change Without Notice

Printed in U.S.A.

D S

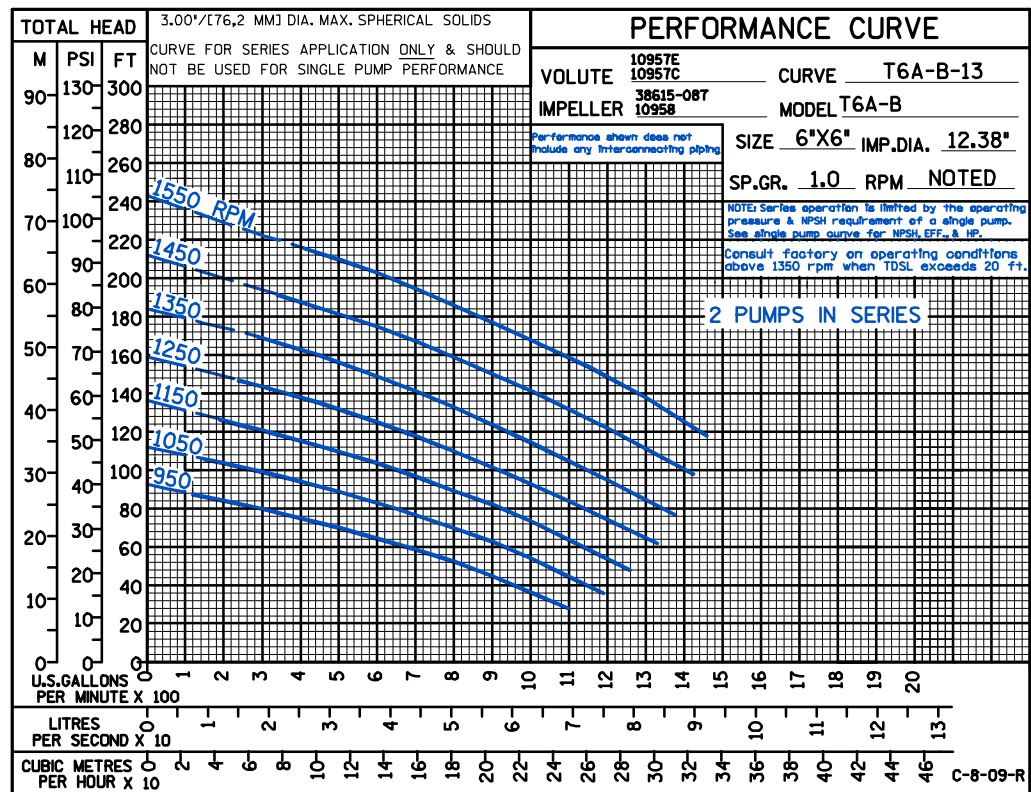
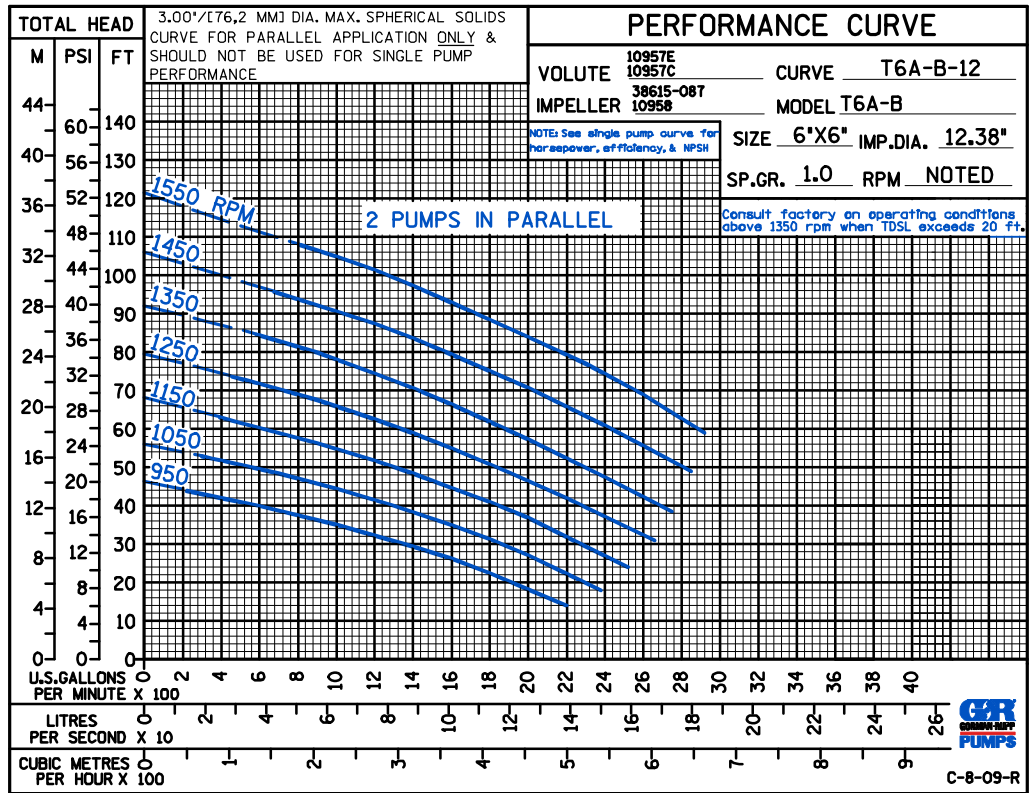

THE GORMAN-RUPP COMPANY • MANSFIELD, OHIO

GORMAN-RUPP OF CANADA LIMITED • ST. THOMAS, ONTARIO, CANADA

Specifications Subject to Change Without Notice

Printed in U.S.A.