

Self Priming Centrifugal Pump

**Super
T SERIES**
VARIOUS PATENTS APPLY

Model T6A3S-B

Size 6" x 6"



PUMP SPECIFICATIONS

Size: 6" x 6" (152 mm x 152 mm) NPT - Female.

Casing: Gray Iron 30.

Maximum Operating Pressure 79 psi (545 kPa).*

Semi-Open Type, Two Vane Impeller: Ductile Iron 65-45-12.

Handles 3" (76.2 mm) Diameter Spherical Solids.

Impeller Shaft: Alloy Steel 4150.

Shaft Sleeve: Alloy Steel 4130.

Replaceable Wear Plate: Carbon Steel 1026.

Removable Adjustable Cover Plate: Gray Iron 30; 62 lbs. (28 kg).

Flap Valve: Neoprene w/Nylon and Steel Reinforcing.

Seal Plate: Gray Iron 30.

Bearing Housing: Gray Iron 30.

Radial Bearing: Open Single Row Ball.

Thrust Bearing: Open Double Row Ball.

Bearing and Seal Cavity Lubrication: SAE 30 Non-Detergent Oil.

Flanges: Gray Iron 30.

Gaskets: Buna-N, Compressed Synthetic Fibers, PTFE, Vegetable Fiber, Cork, and Rubber.

O-Rings: Buna-N.

Hardware: Standard Plated Steel.

Brass Pressure Relief Valve.

Bearing and Seal Cavity Oil Level Sight Gauges.

Optional Equipment: Metal Bellows Seal. Automatic Air

Release Valve. 120V/240V Casing Heater. High Pump

Temperature Shutdown Kit. G-R Hard Iron Casing.

Gray Iron 30 Suction and Discharge Spool Flanges:

6" ASA (**Specify Model T6A3S-B /F**).

150 mm DIN 2527 (PN16) (**Specify Model T6A3S-B /FM**).

**Consult Factory for Applications Exceeding
Maximum Pressure and/or Temperature Indicated.*



Shown with Optional Suction & Discharge Spool Flanges (Available in ASA or DIN Standard Sizes).

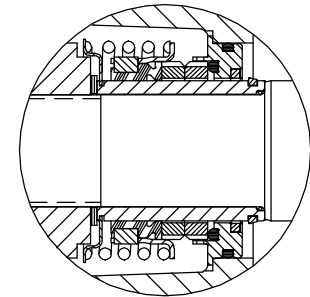
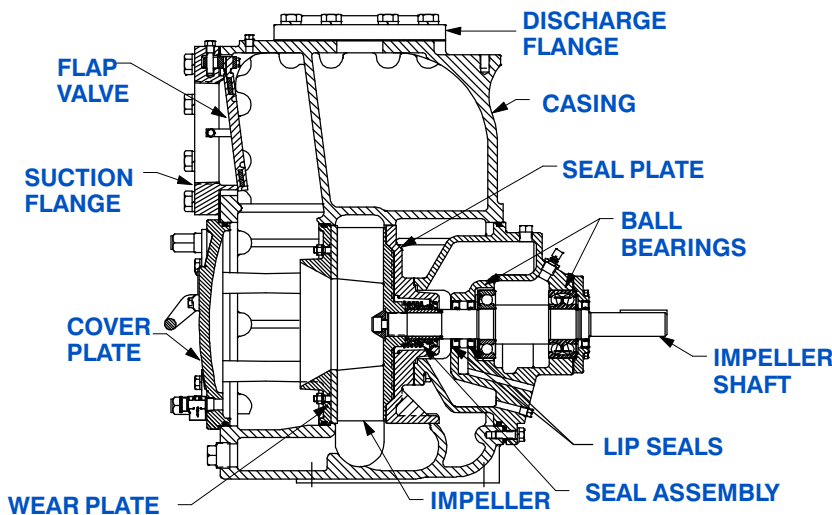

SEAL DETAIL

Cartridge Type, Mechanical, Oil-Lubricated, Double Floating, Self-Aligning. Tungsten Titanium Carbide Rotating and Stationary Faces. Stainless Steel 316 Stationary Seat. Fluorocarbon Elastomers (DuPont Viton® or Equivalent). Stainless Steel 18-8 Cage and Spring. Maximum Temperature of Liquid Pumped, 160°F (71°C).*



GORMAN-RUPP PUMPS

www.grpumps.com

Specifications Subject to Change Without Notice

Printed in U.S.A.

Specification Data

APPROXIMATE DIMENSIONS and WEIGHTS

NET WEIGHT: 855 LBS. (388 KG.)*
SHIPPING WEIGHT: 910 LBS. (413 KG.)*
EXPORT CRATE: 32.5 CU. FT. (0,92 CU. M.)
***ADD 25 LBS. (11,3 KG.) W/EACH SPOOL FLANGE**

SECTION 55, PAGE 2200C

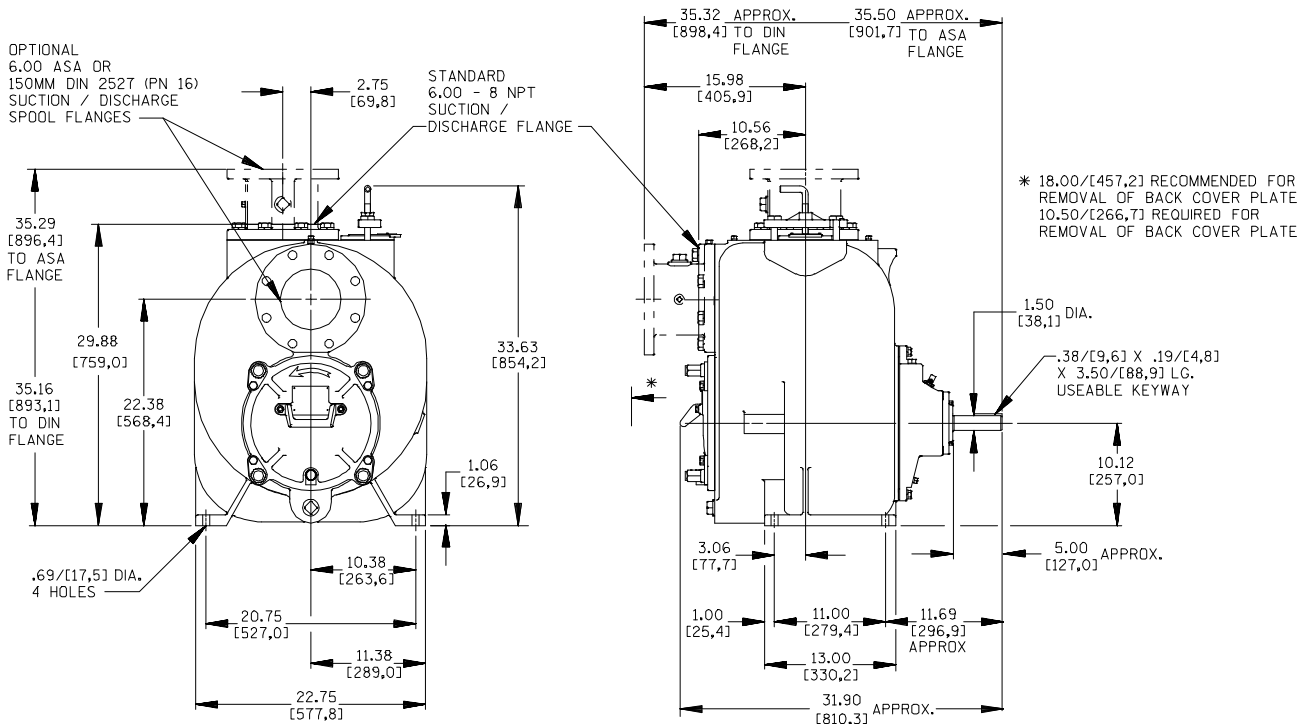

OPTIONAL ASA OR DIN STANDARD SUCTION & DISCHARGE SPOOL FLANGES AVAILABLE

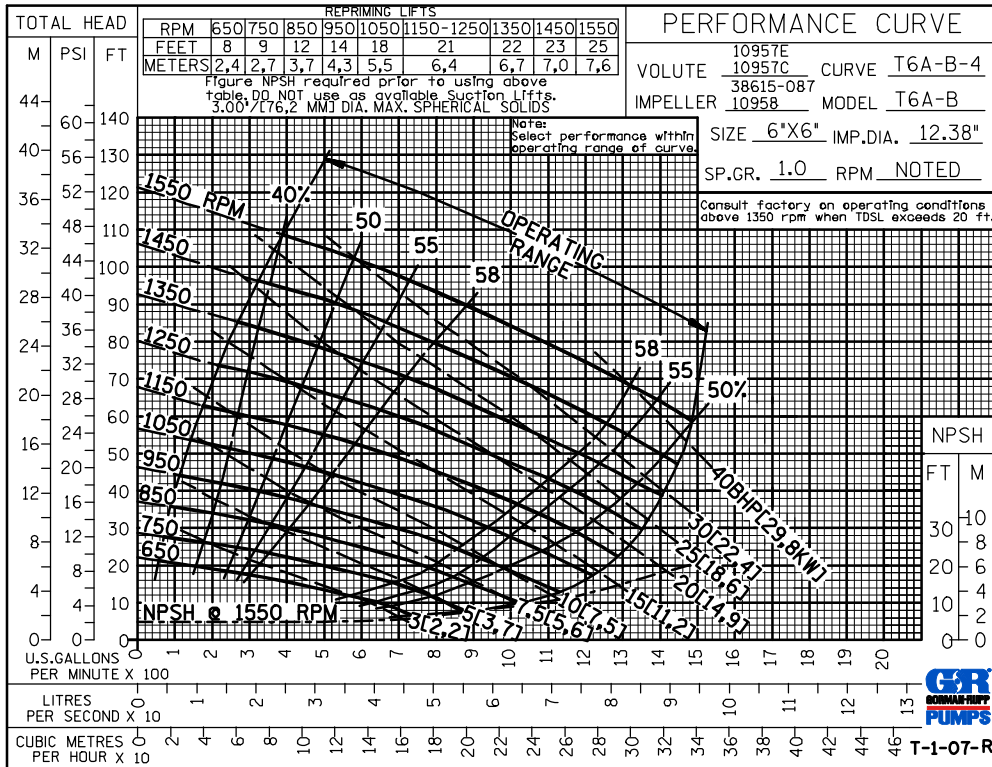

GORMAN-RUPP PUMPS

www.grpumps.com

Specifications Subject to Change Without Notice

Printed in U.S.A.

CDS

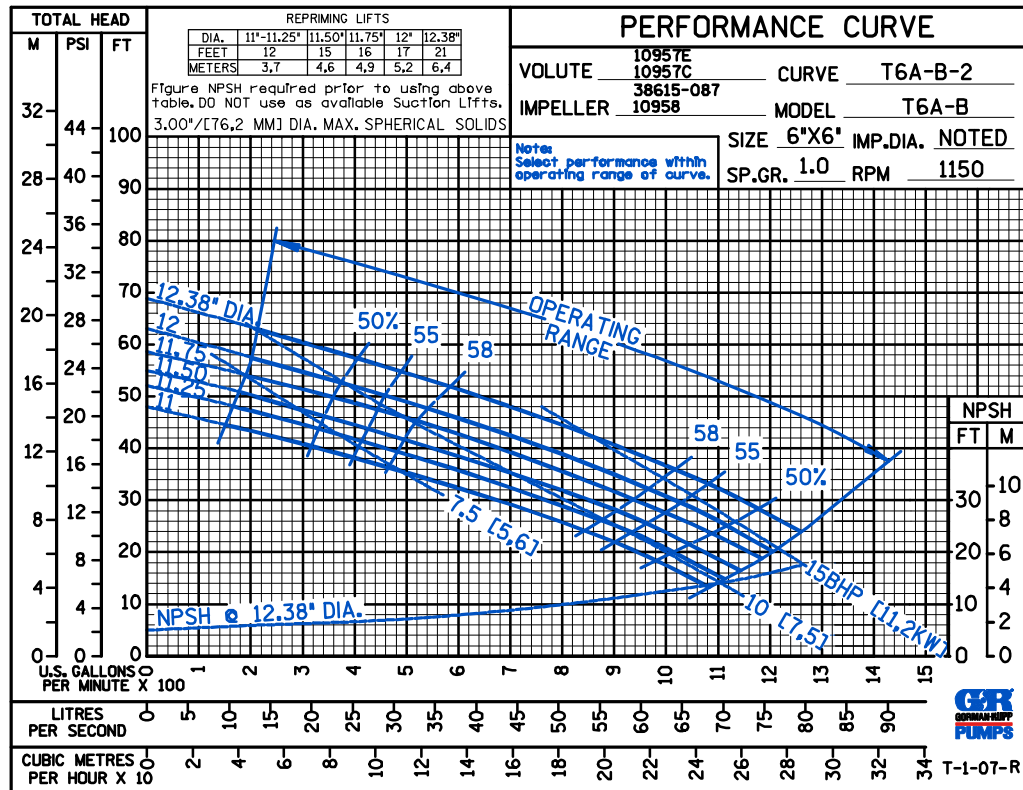
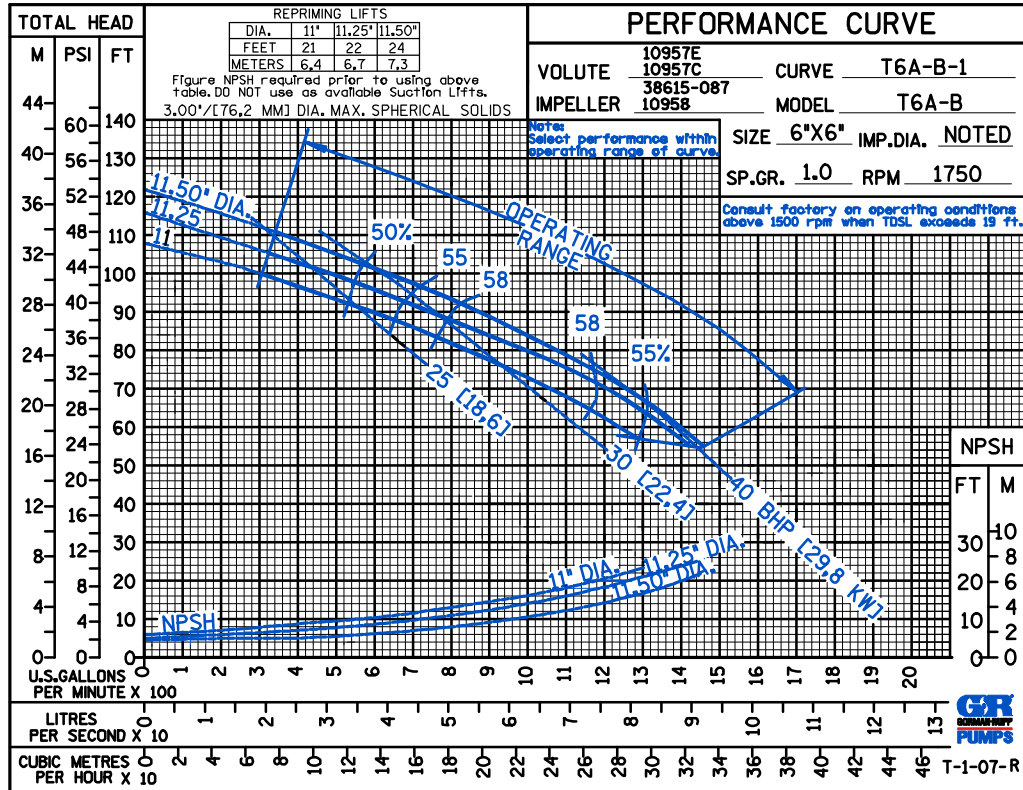

THE GORMAN-RUPP COMPANY • MANSFIELD, OHIO

GORMAN-RUPP OF CANADA LIMITED • ST. THOMAS, ONTARIO, CANADA

Specifications Subject to Change Without Notice

Printed in U.S.A.

CDS

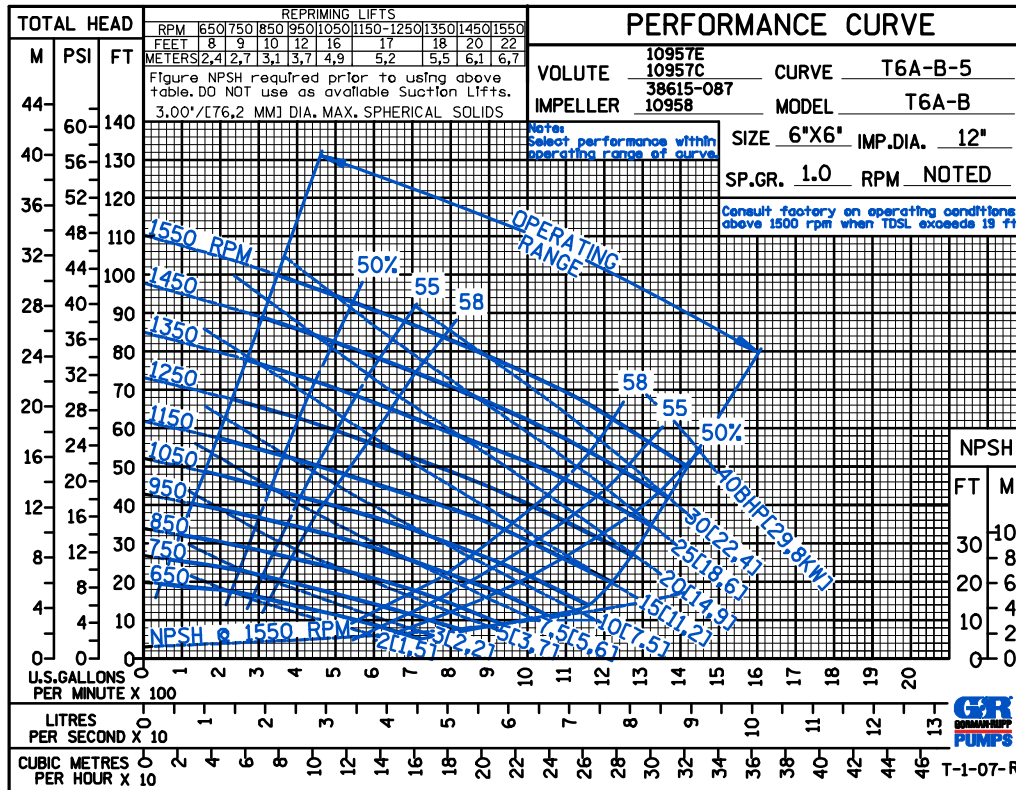
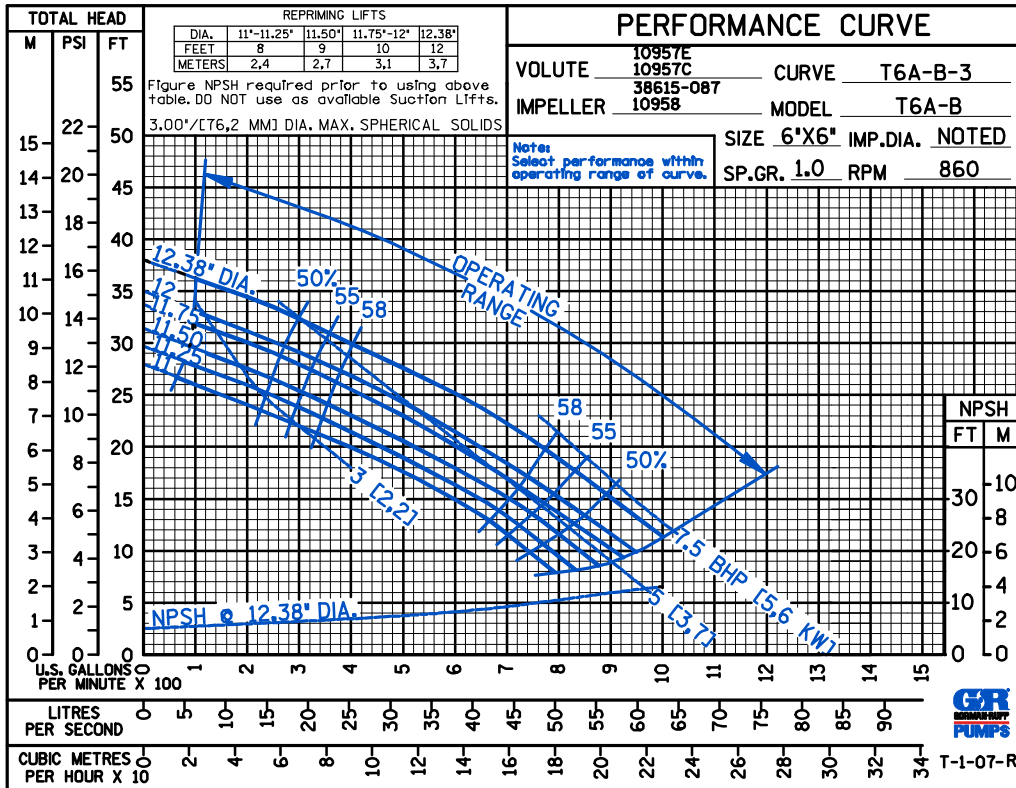

THE GORMAN-RUPP COMPANY • MANSFIELD, OHIO

GORMAN-RUPP OF CANADA LIMITED • ST. THOMAS, ONTARIO, CANADA

Specifications Subject to Change Without Notice

Printed in U.S.A.

CDS

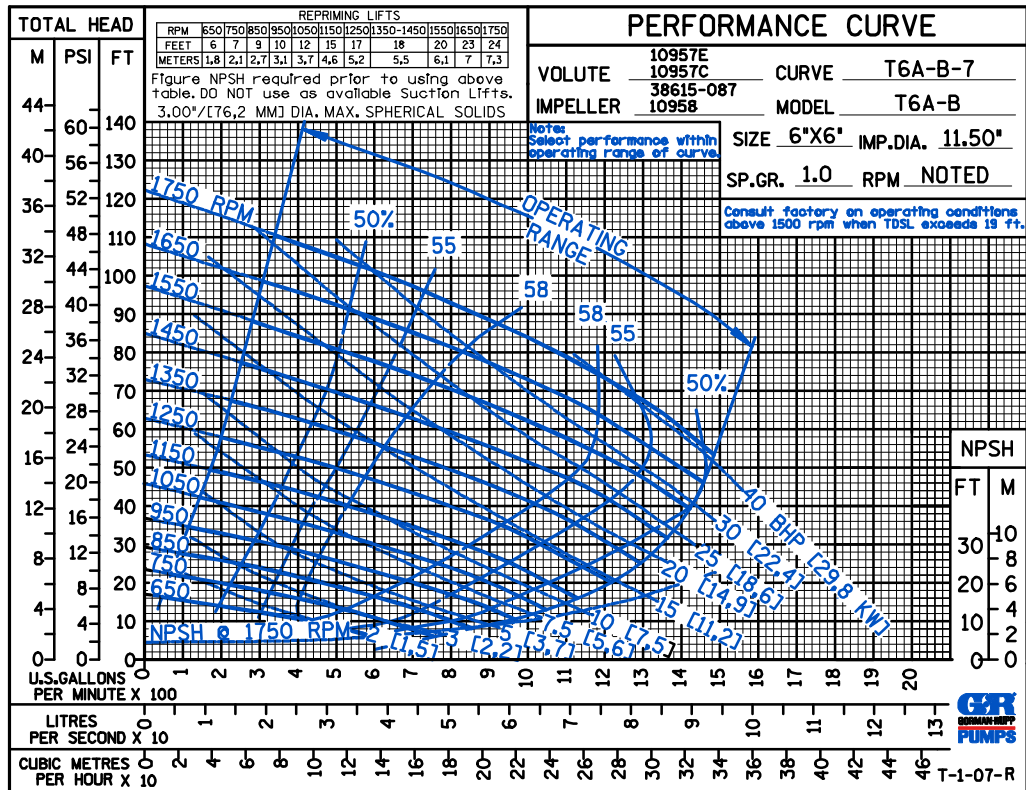
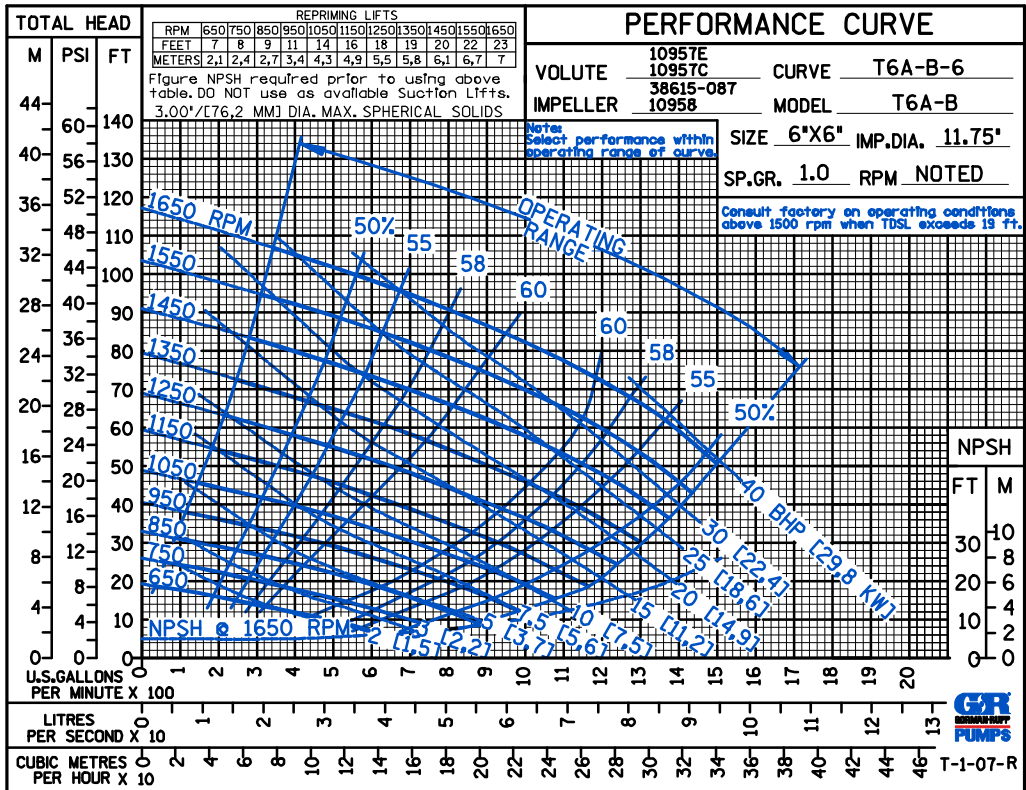

THE GORMAN-RUPP COMPANY • MANSFIELD, OHIO

GORMAN-RUPP OF CANADA LIMITED • ST. THOMAS, ONTARIO, CANADA

Specifications Subject to Change Without Notice

Printed in U.S.A.

CDS

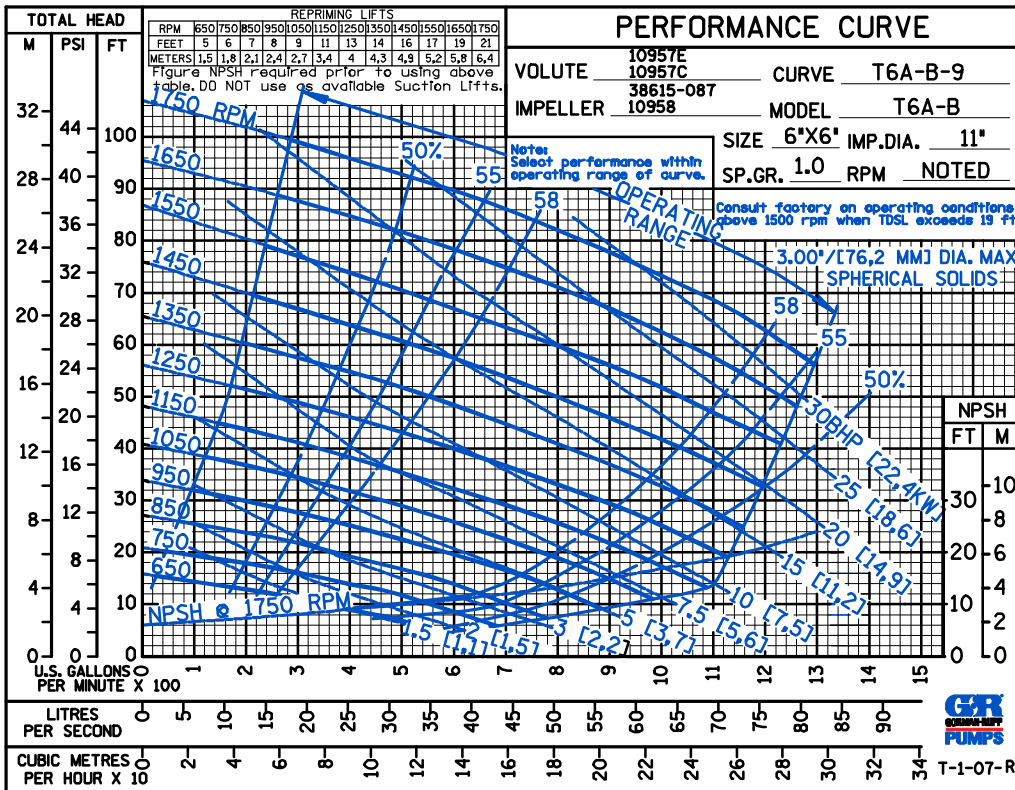
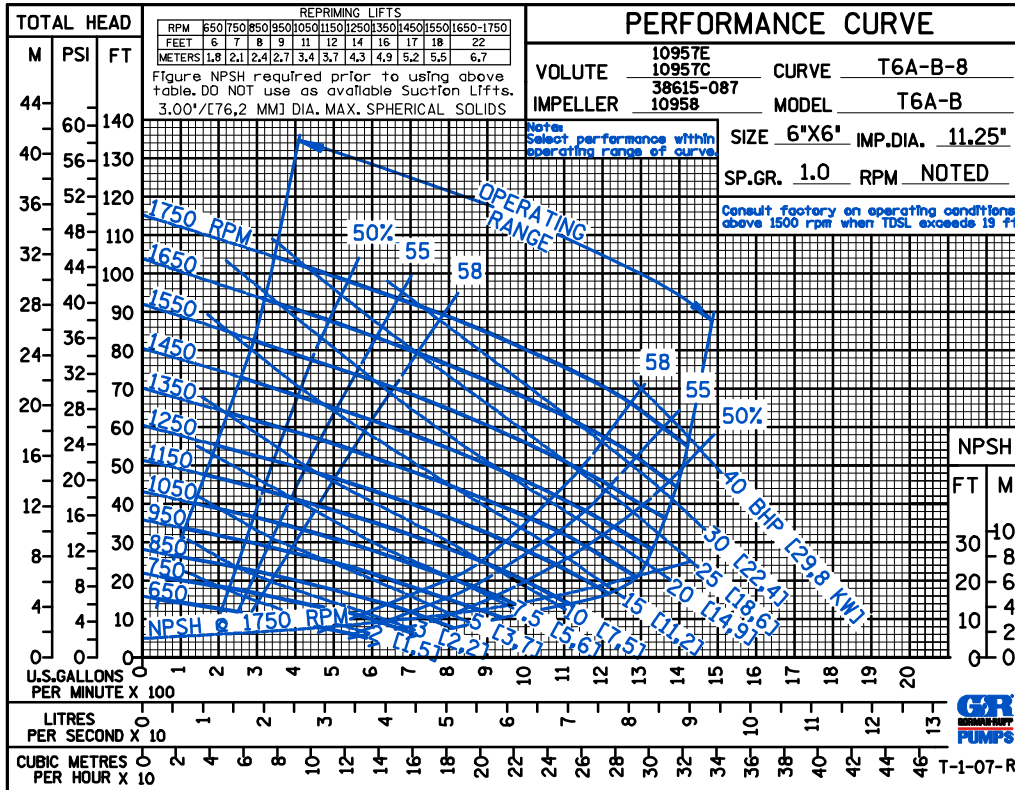

THE GORMAN-RUPP COMPANY • MANSFIELD, OHIO

GORMAN-RUPP OF CANADA LIMITED • ST. THOMAS, ONTARIO, CANADA

Specifications Subject to Change Without Notice

Printed in U.S.A.

D S

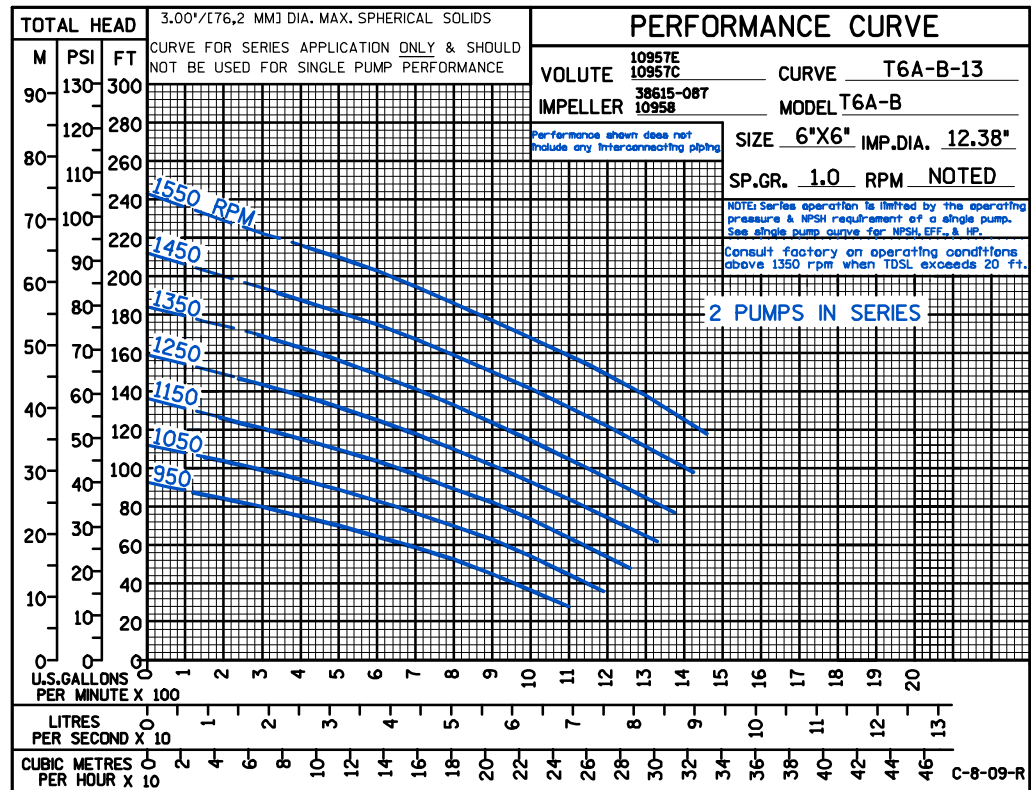
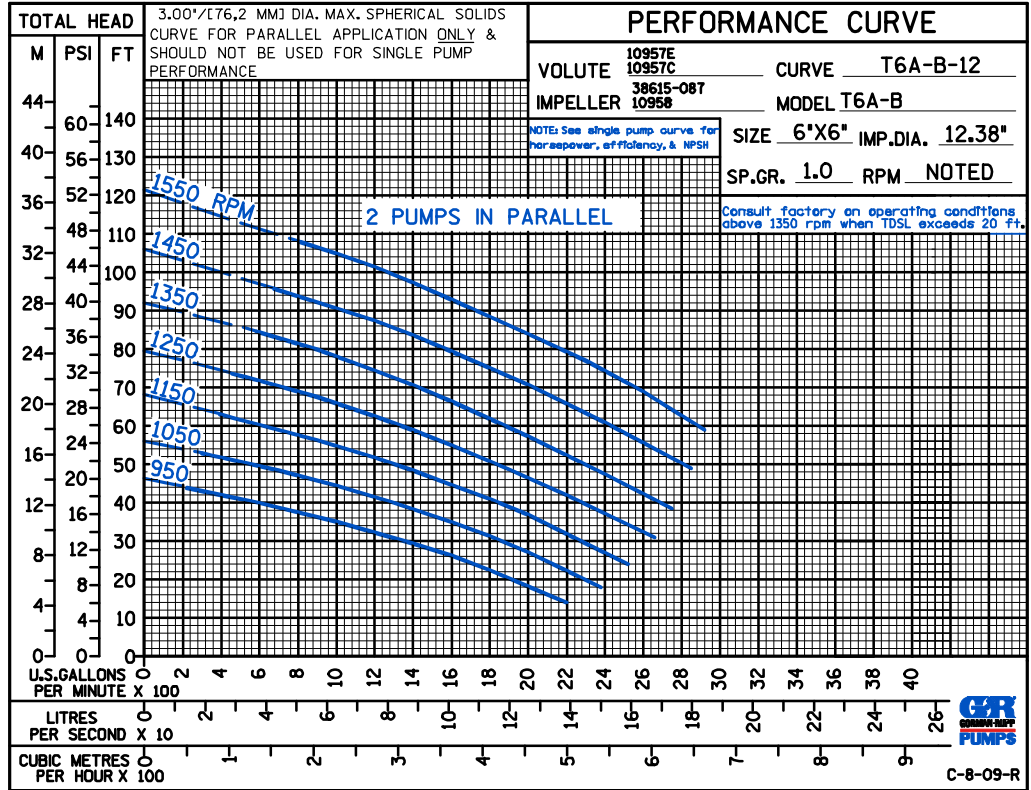

THE GORMAN-RUPP COMPANY • MANSFIELD, OHIO

GORMAN-RUPP OF CANADA LIMITED • ST. THOMAS, ONTARIO, CANADA

Specifications Subject to Change Without Notice

Printed in U.S.A.