

Basic Pump

Self Priming Centrifugal Pump

Super
T SERIES

Model T10A60S-B

Size 10" x 10"



PUMP SPECIFICATIONS

Size: 10" x 10" (254 mm x 254 mm) Flanged.

Casing: Gray Iron 30.

Maximum Operating Pressure 99 psi (683 kPa).*

Semi-Open Type, Two Vane Impeller: Ductile Iron 65-45-12.

Handles 3" (76,2 mm) Diameter Spherical Solids.

Impeller Shaft: Stainless Steel 17-4 PH.

Shaft Sleeve: Alloy Steel 4130.

Replaceable Front Wear Plate: Ductile Iron 80-55-06.

Replaceable Rear Wear Plate: Carbon Steel 1026.

Removable Clean-out Cover Plate: Gray Iron 30; 9 lbs. (4 kg).

Flap Valve: Neoprene w/Steel Reinforcing.

Seal Plate: Gray Iron 30.

Bearing Housing: Gray Iron 30.

Radial and Thrust Bearings: Open Double Row Ball.

Bearing and Seal Cavity Lubrication: SAE 30 Non-Detergent Oil.

Suction Flange: Gray Iron 30.

Suction Head: Gray Iron 30.

Gaskets: Buna-N, PTFE, Cork, and Rubber.

O-Rings: Buna-N.

Hardware: Standard Plated Steel.

Brass Pressure Relief Valve.

Bearing and Seal Cavity Oil Level Sight Gauges.

Optional Equipment: Metal Bellows Seal. Automatic Air Release Valve. High Pump Temperature Shutdown Kit. 120V/240V Casing Heater. Continuous Vane Ductile Iron Impeller.

Gray Iron 30 Spool Flanges:

10" ASA Discharge.

250 mm DIN 2527 (PN 16) Suction and Discharge

(Specify Model T10A60S-B /FM).

**Consult Factory for Applications Exceeding Maximum Pressure and/or Temperature Indicated.*



Shown with Optional Discharge Spool Flange (Suction/Discharge Spool Flanges Available in ASA or DIN Standard Sizes).

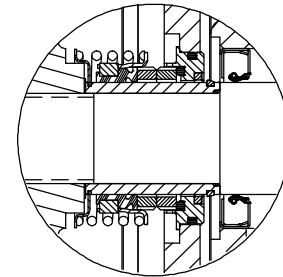
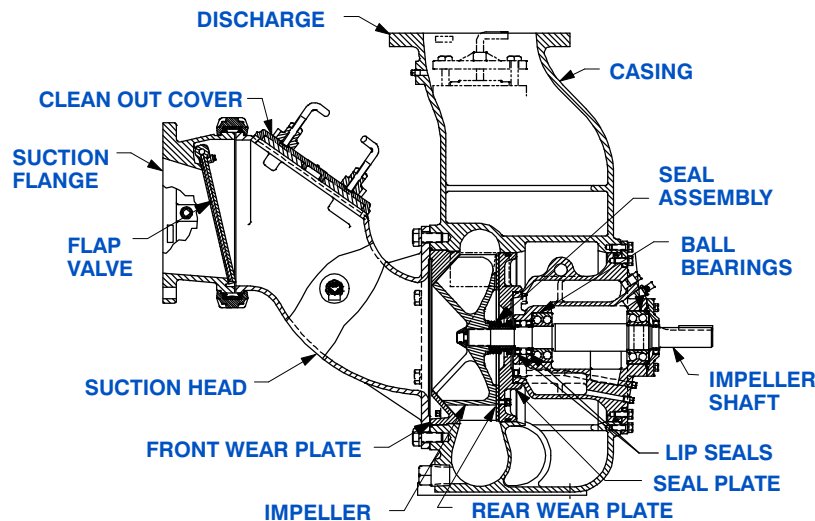

SEAL DETAIL

Cartridge Type, Mechanical, Oil-Lubricated, Double Floating, Self-Aligning. Silicon Carbide Rotating and Stationary Faces. Stainless Steel 316 Stationary Seat. Fluorocarbon Elastomers (DuPont Viton® or Equivalent). Stainless Steel 18-8 Cage and Spring. Maximum Temperature of Liquid Pumped, 160°F (71°C).*



GORMAN-RUPP PUMPS

www.grpumps.com

Specifications Subject to Change Without Notice

Printed in U.S.A.

Specification Data

SECTION 55, PAGE 2410C

APPROXIMATE DIMENSIONS and WEIGHTS

NET WEIGHT: 1440 LBS. (653 KG.)*
SHIPPING WEIGHT: 1590 LBS. (721 KG.)*
EXPORT CRATE: 70.3 CU. FT. (2 CU. M.)
***ADD 71 LBS. (32,2 KG.) W/DISCH SPOOL FLANGE**

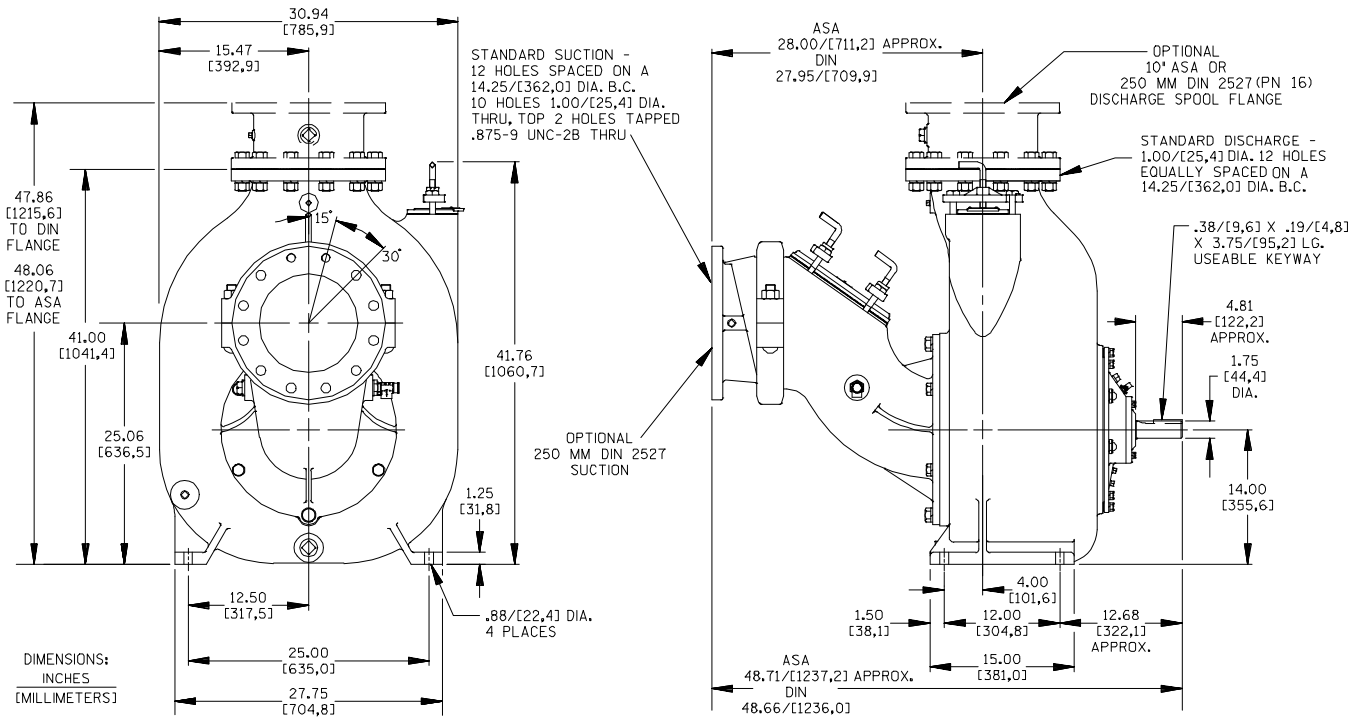

OPTIONAL ASA OR DIN STANDARD SPOOL FLANGES AVAILABLE

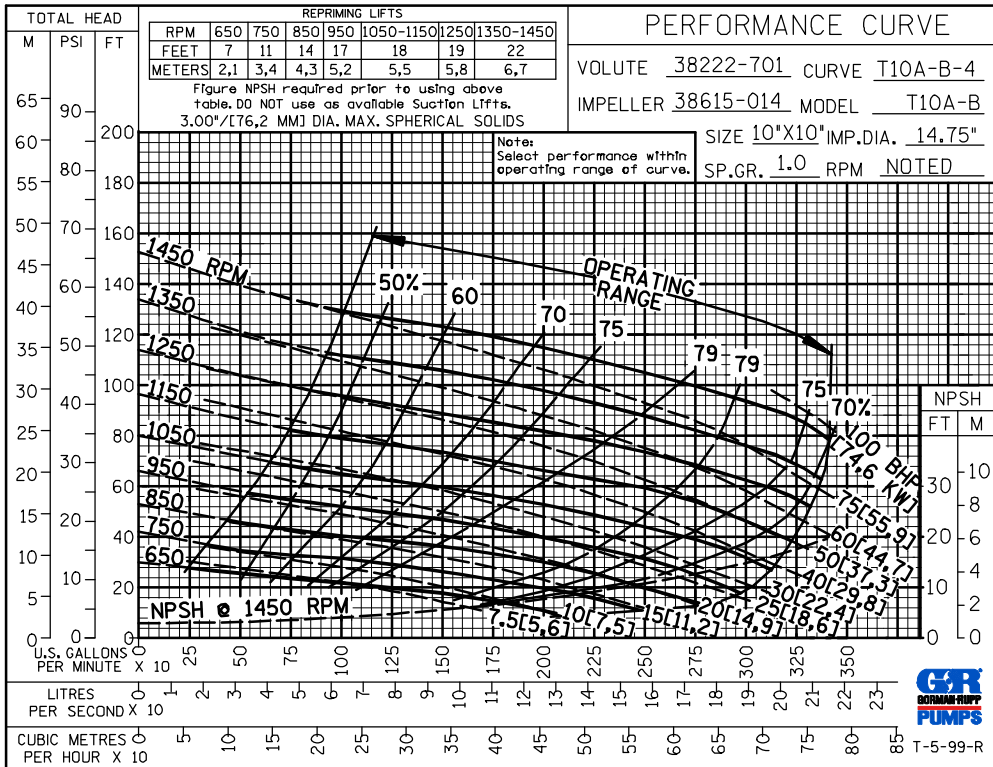

GORMAN-RUPP PUMPS

www.grpumps.com

Specifications Subject to Change Without Notice

Printed in U.S.A.

CDS

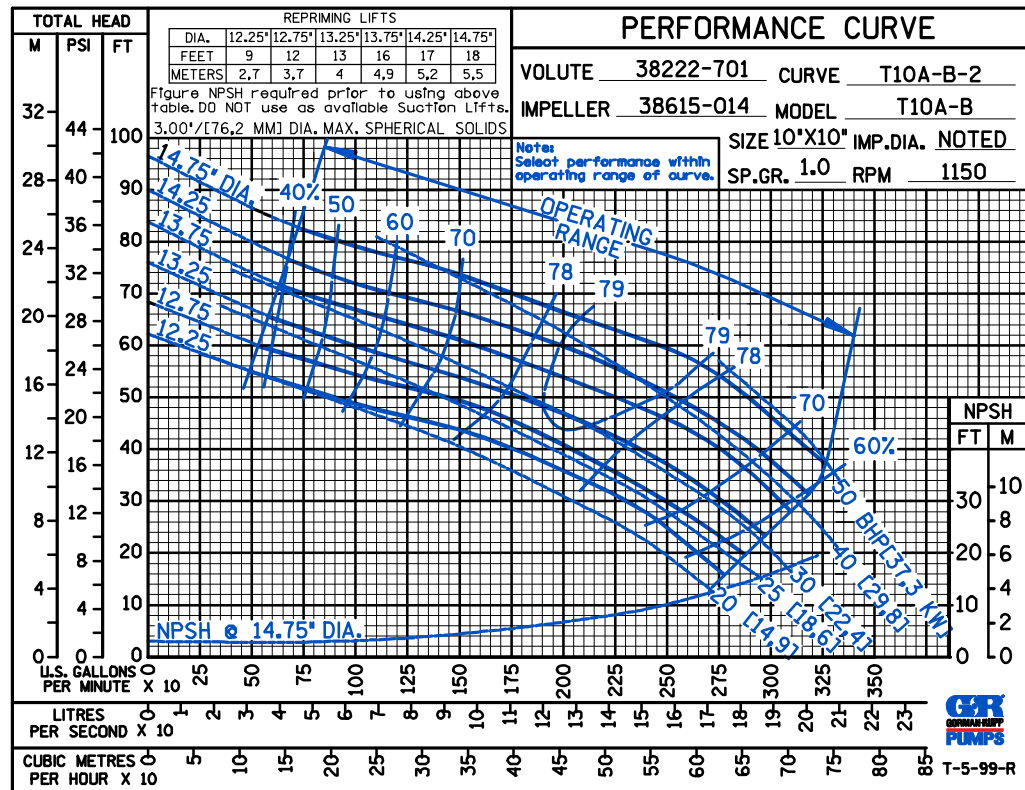
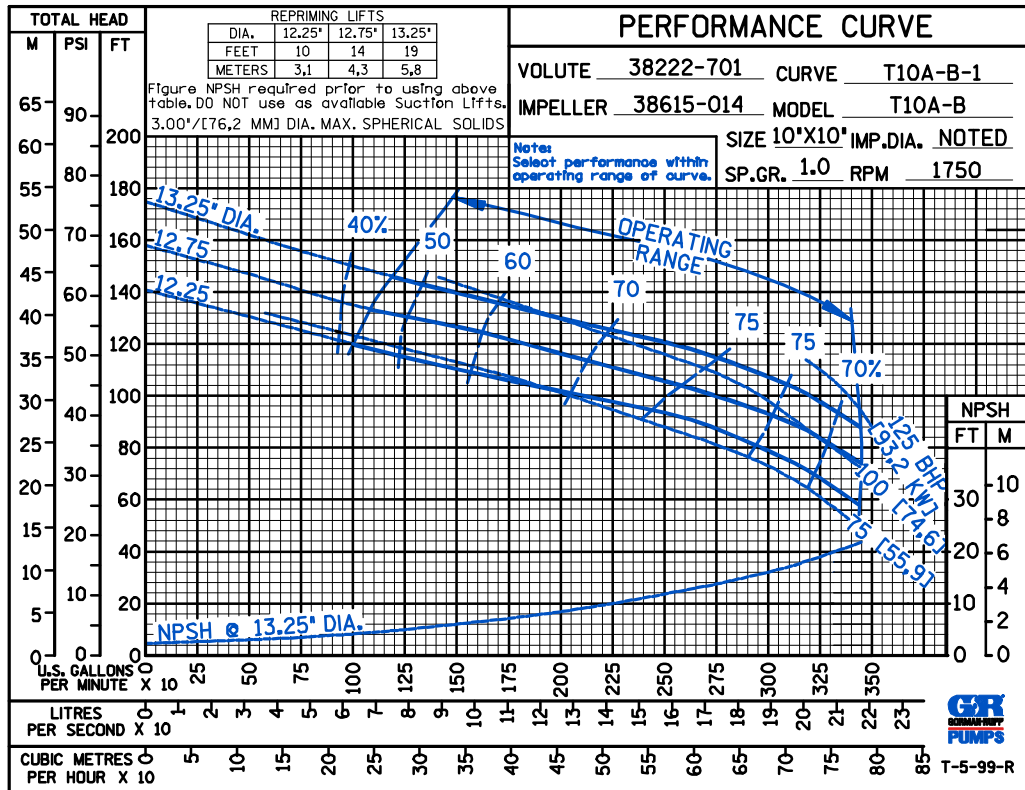

THE GORMAN-RUPP COMPANY • MANSFIELD, OHIO

GORMAN-RUPP OF CANADA LIMITED • ST. THOMAS, ONTARIO, CANADA

Specifications Subject to Change Without Notice

Printed in U.S.A.

CDS

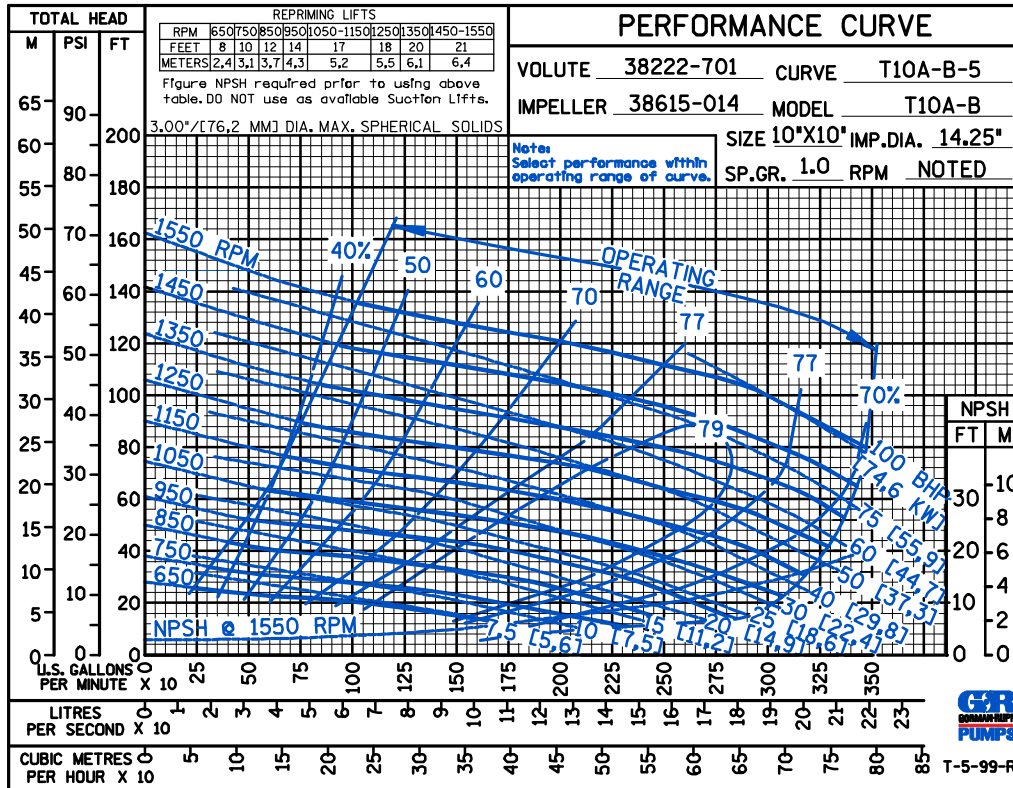
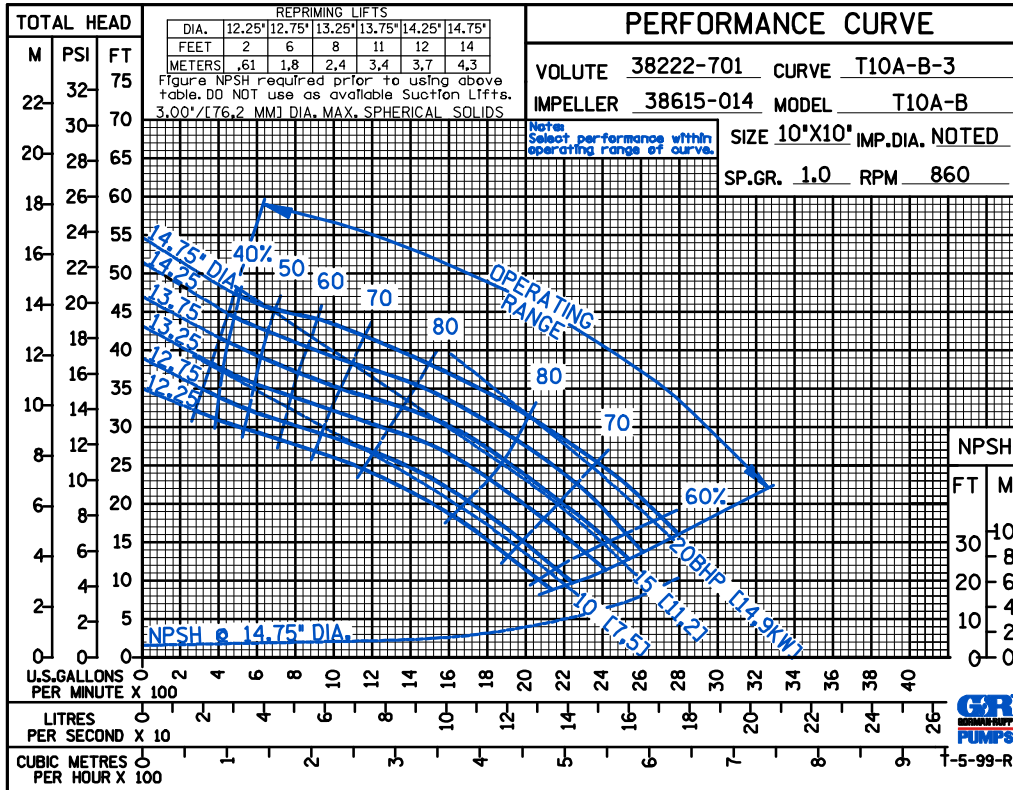

THE GORMAN-RUPP COMPANY • MANSFIELD, OHIO

GORMAN-RUPP OF CANADA LIMITED • ST. THOMAS, ONTARIO, CANADA

Specifications Subject to Change Without Notice

Printed in U.S.A.

CDS

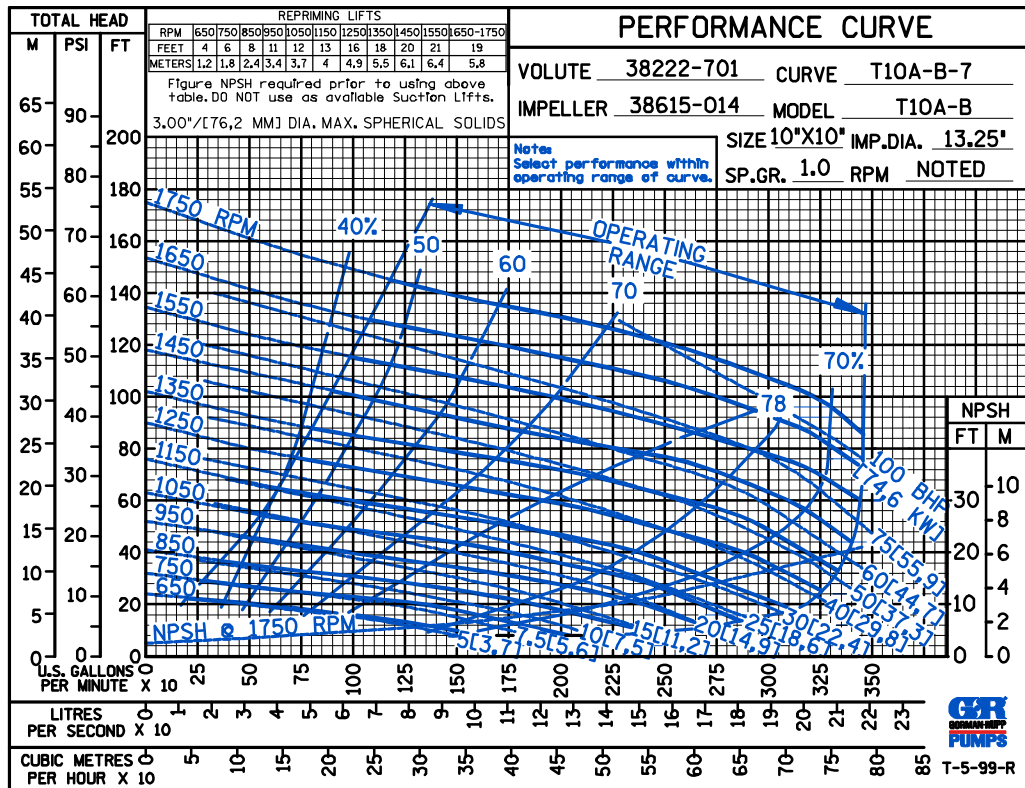
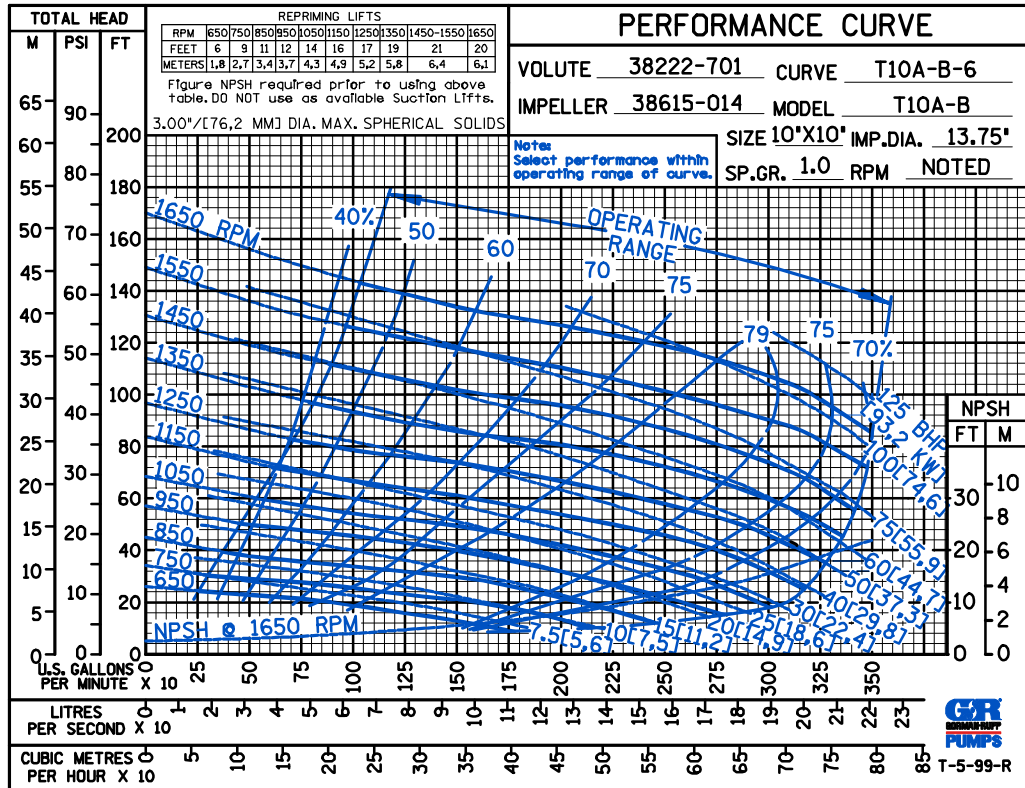

THE GORMAN-RUPP COMPANY • MANSFIELD, OHIO

GORMAN-RUPP OF CANADA LIMITED • ST. THOMAS, ONTARIO, CANADA

Specifications Subject to Change Without Notice

Printed in U.S.A.

CDS

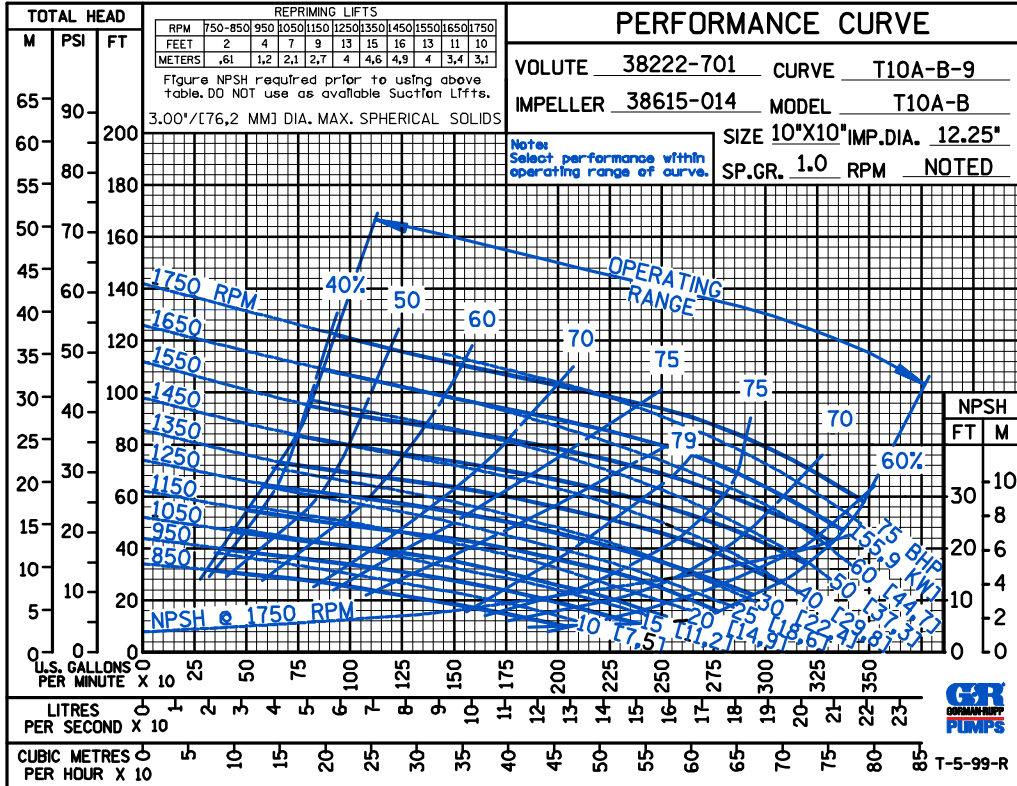
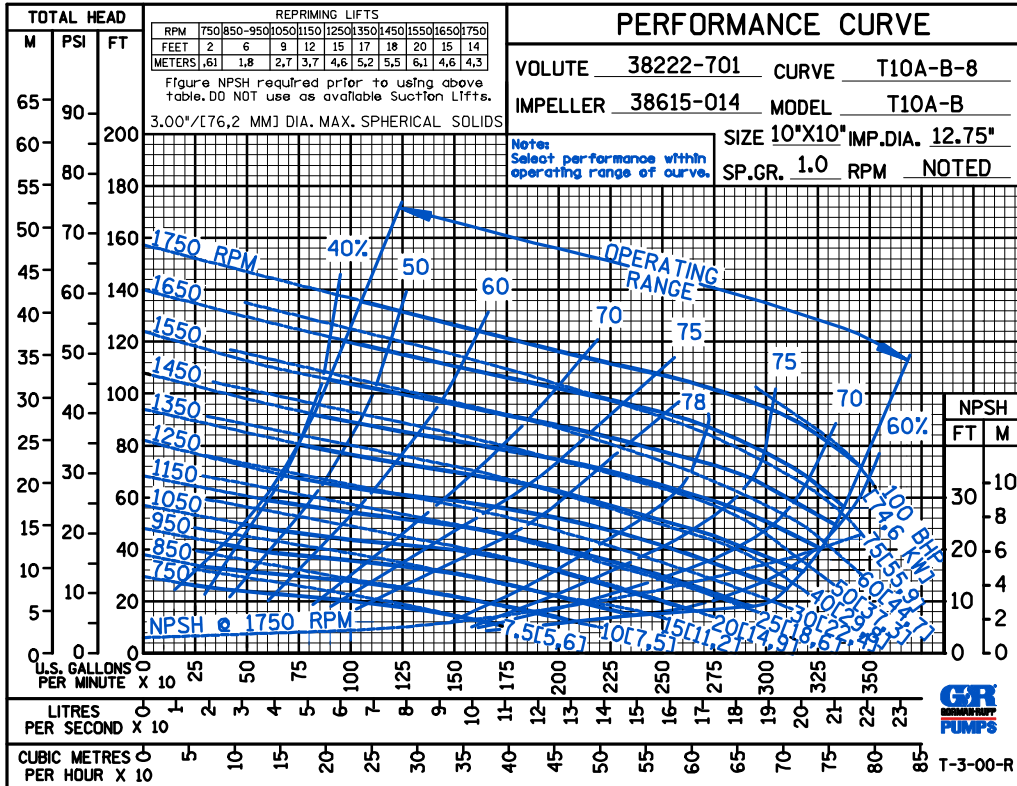

THE GORMAN-RUPP COMPANY • MANSFIELD, OHIO

GORMAN-RUPP OF CANADA LIMITED • ST. THOMAS, ONTARIO, CANADA

Specifications Subject to Change Without Notice

Printed in U.S.A.

D S

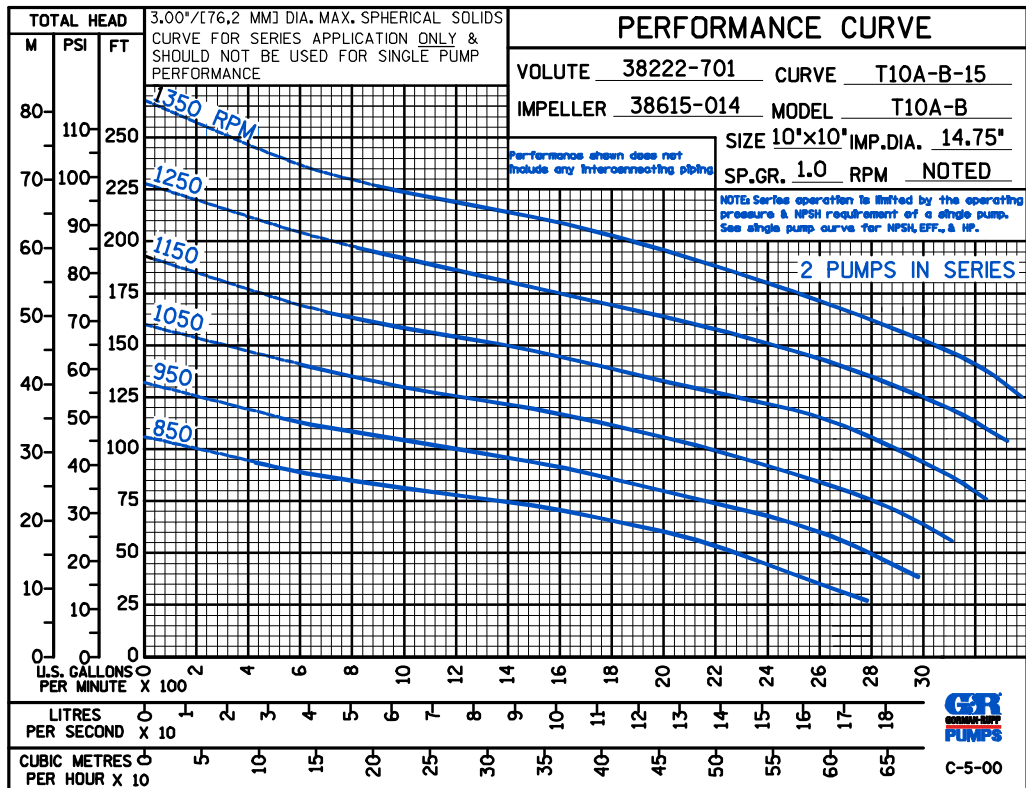
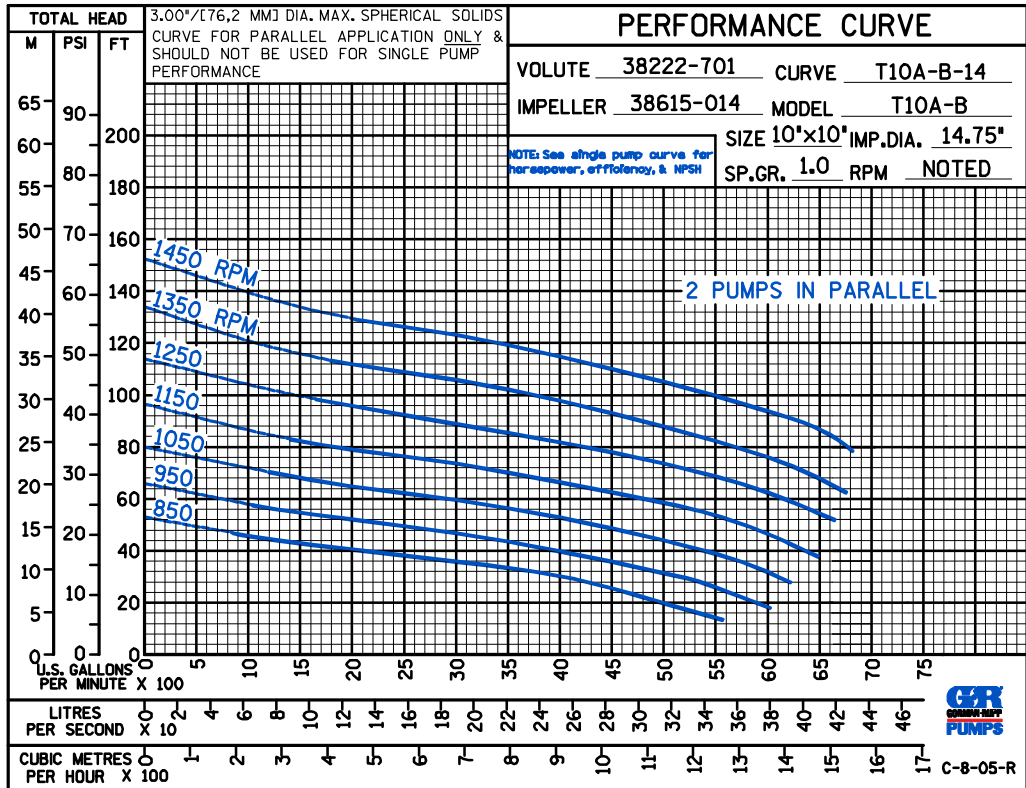

THE GORMAN-RUPP COMPANY • MANSFIELD, OHIO

GORMAN-RUPP OF CANADA LIMITED • ST. THOMAS, ONTARIO, CANADA

Specifications Subject to Change Without Notice

Printed in U.S.A.

CDS

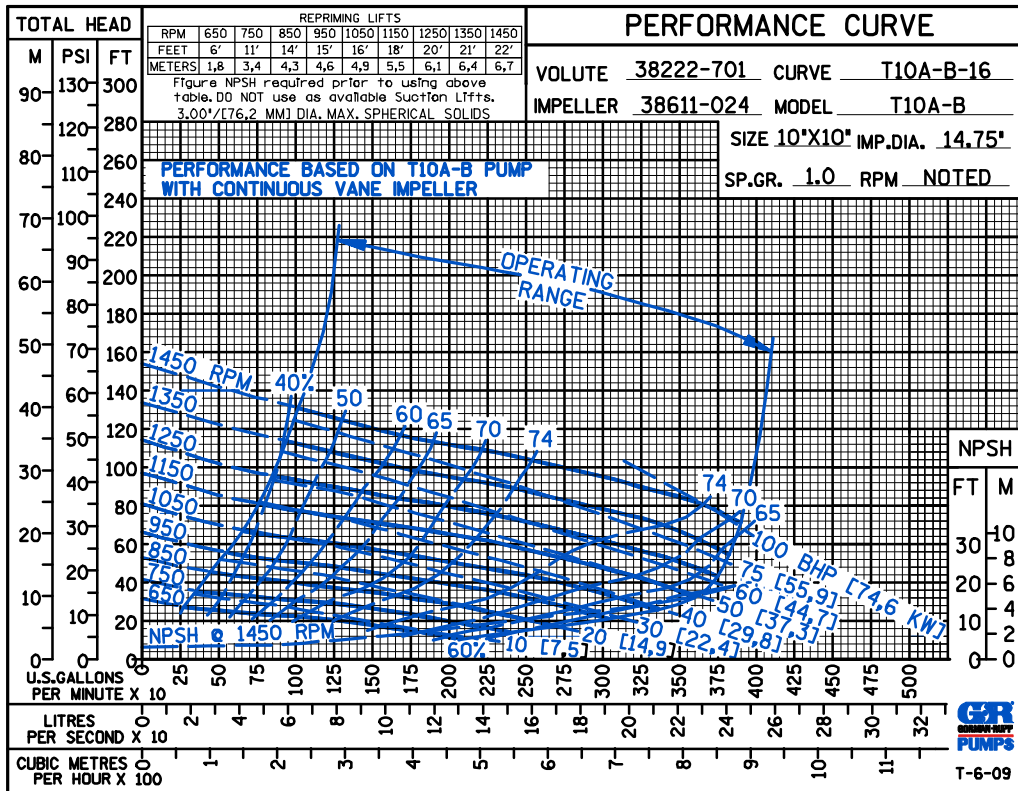

THE GORMAN-RUPP COMPANY • MANSFIELD, OHIO

GORMAN-RUPP OF CANADA LIMITED • ST. THOMAS, ONTARIO, CANADA

Specifications Subject to Change Without Notice

Printed in U.S.A.