

INDUSTRIAL FLUID FILTRATION SOLUTIONS

Increase Process Efficiency
Reduce Maintenance Costs
Lower Energy Costs

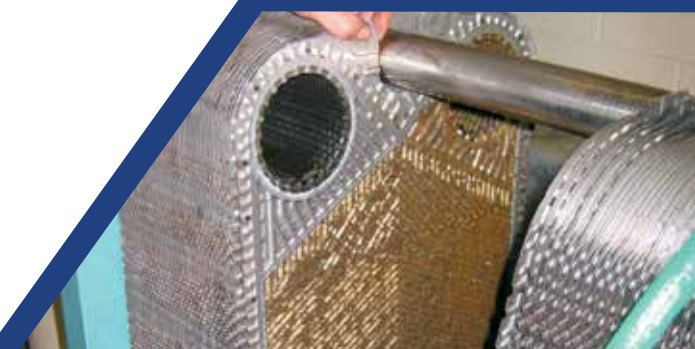

Pre-Filtration



Protect Heat Exchangers



Reduce Waste



Protect Spray Nozzles



Prevent Solids Accumulation in Sumps and Basins

Pre-Filtration



Using a LAKOS Separator as a pre-filter prior to finer filtration improves efficiency and minimizes liquid loss. As a result:

- Reduce disposal cost
- Minimize labor, maintenance downtime and filter media replacement costs
- Extend the life of finer filtration and water treatment systems
- Increase the life of filter cartridges and bags and eliminates water treatment processes

Protect Heat Exchangers



LAKOS Separators offer effective protection for heat exchangers against fouling. As a result:

- Maintain design efficiencies for better heat transfer rates = energy savings
- Reduce maintenance frequency for heat exchanger equipment
- Remove suspended grit and scale

Protect Spray Nozzles



LAKOS Separators removes solids that clog spray nozzles and other small orifices. This helps to:

- Maintain original nozzle design for efficient spray coverage
- Prevent wear abrasion and clogging – reducing frequency of nozzle replacement
- Maintain overall product quality through cleaner nozzles, reducing the need to scrap product due to quality

Reduce Waste



LAKOS Separators remove solids from liquids in your industrial process and allow reuse of the liquid. As a result:

- Reduce disposal cost
- Extends the life of process liquids by removing troublesome solids
- Concentrates solids for easy disposal or allows for recovery of high value solids
- Reduces replacement of downstream filter elements/media
- Improve water chemistry
- Extend the life of pump seals, valves, and process equipment

Prevent Solids Accumulation in Sumps and Basins



Using a LAKOS Separator as part of your process cooling system minimizes accumulation of solids that typically settle in sumps and basins. As a result:

- Fewer shutdowns
- Reduces solids build-up and decreases clean out time
- Avoids solids-induced microbial growth, decreases chemical use, and increases process liquid life

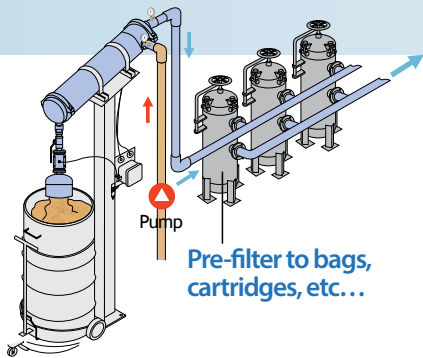

Reduced Paint Defects in Auto Assembly Plant:

- Resulted in cleaner downstream water
- Fewer bag change outs
- Reduced paint defects by 85%



See literature AB-199

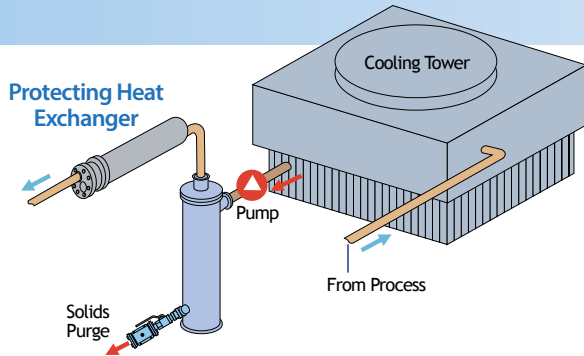

Separator Removes Metal Scale and Reduces Heat Exchanger Maintenance Costs:

- Significantly reduced annual costs for maintenance by 90%
- Saved water
- Increased period between shutdowns from 5 weeks to 52 weeks



See literature AB-220

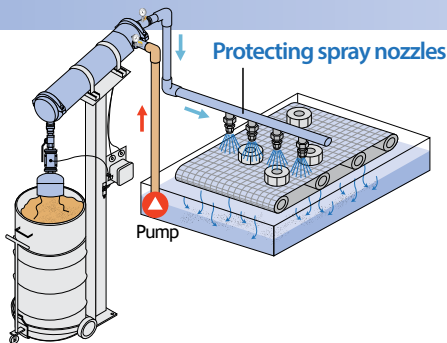

Nozzle Replacement and Maintenance Decreases, Production Increases:

- Reduced spray nozzle replacement by 90%
- Decreased cooling reduced product rejection by 30%
- Led to improved employee morale



See literature AB-207

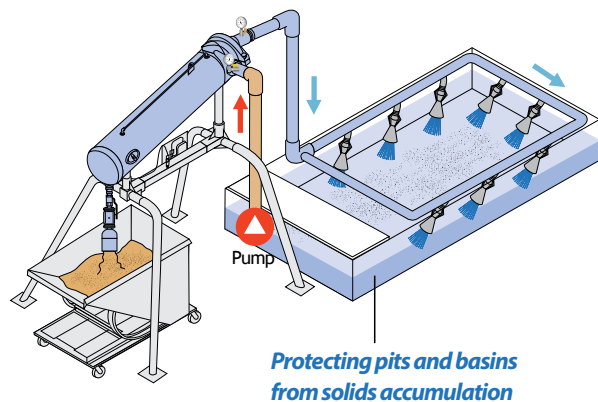

Separator Recovers Copper Solids from Liquid Scrubbers:

- Eliminated plugged nozzles
- Prevented damage to valves
- Mitigated pump casing erosion
- Recycling of copper paid for system in less than 2 months



See literature AB-214

LAKOS Improves Product Quality with Tank Cleaning System:

- Eliminated plugged nozzles
- Prevented clogging of Heat Exchangers
- Reduced downtime from 3 times per week to once every 3 month
- Reduced maintenance costs from \$15,600 per year to \$400 per year



See literature AB-233

What LAKOS Removes

Effective Separator operation depends upon the difference in specific gravity between solids and the liquid. The greater the difference - the higher the removal efficiency.

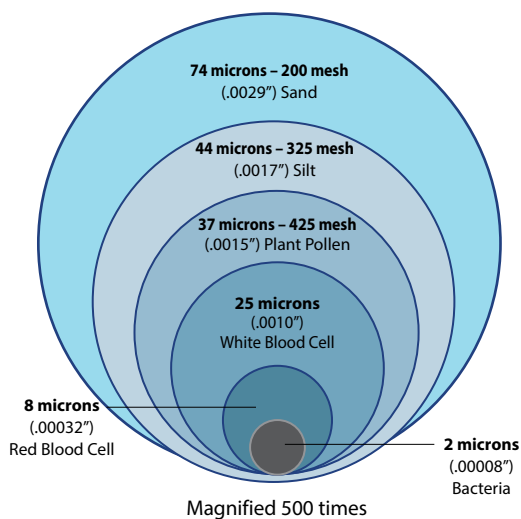

In addition to specific gravity, particle size affects separation efficiency. To gain perspective, 40 micron is at the visibility threshold. LAKOS Separators are highly effective at removing solids 44 micron and larger at specific gravity 2.6 and greater.

LAKOS Separators use slots to accelerate liquid and minimize turbulence - allowing highly efficient centrifugal separation of solids from liquids

Human hair thickness: .0016 (40 microns)

Commonly Separable Materials and Specific Gravities

| | | | |
|------------------------|-----------|---------------------|------------|
| Aluminum | 2.7 | Iron | 7.8 |
| Ashes (Coal) | 2.0 | Lead | 11.3 |
| Brass | 9.0 | Limestone | 2.8 |
| Bronze; Copper | 8.9 | Manganese | 7.4 |
| Carbon; Concrete; Lava | 1.8 - 2.5 | Mill Scale | 5.4 - 6.1 |
| Coal (Anthracite) | 1.3 - 1.9 | Nickel | 8.9 |
| Earth (Silt; Soil) | 1.2 - 2.0 | Sand; Silica; Shale | 2.6 - 2.8 |
| Glass (Crystal) | 3.0 | Steel | 7.8 |
| Granite; Gravel | 2.5 - 3.0 | Tin Ore | 6.4 - 7.0 |
| Graphite | 2.3 | Water | 1.0 |

Benefits of LAKOS Centrifugal Separators:

- Continuous, uninterrupted filtration removal (no standby equipment required)
- Single pass predictability as high as 98% of 44 microns, given solids with specific gravity of 2.6 and water at 1.0
- No screens or filter elements to plug/fill
- Zero to minimal liquid loss



- Increases productivity/process efficiency
- Lowers energy costs
- Reduces maintenance costs/ extends equipment life
- Conveniently handles waste
- Lowers health risks
- Reduces fluid and/or pressure loss
- Concentrated solids for easy handling

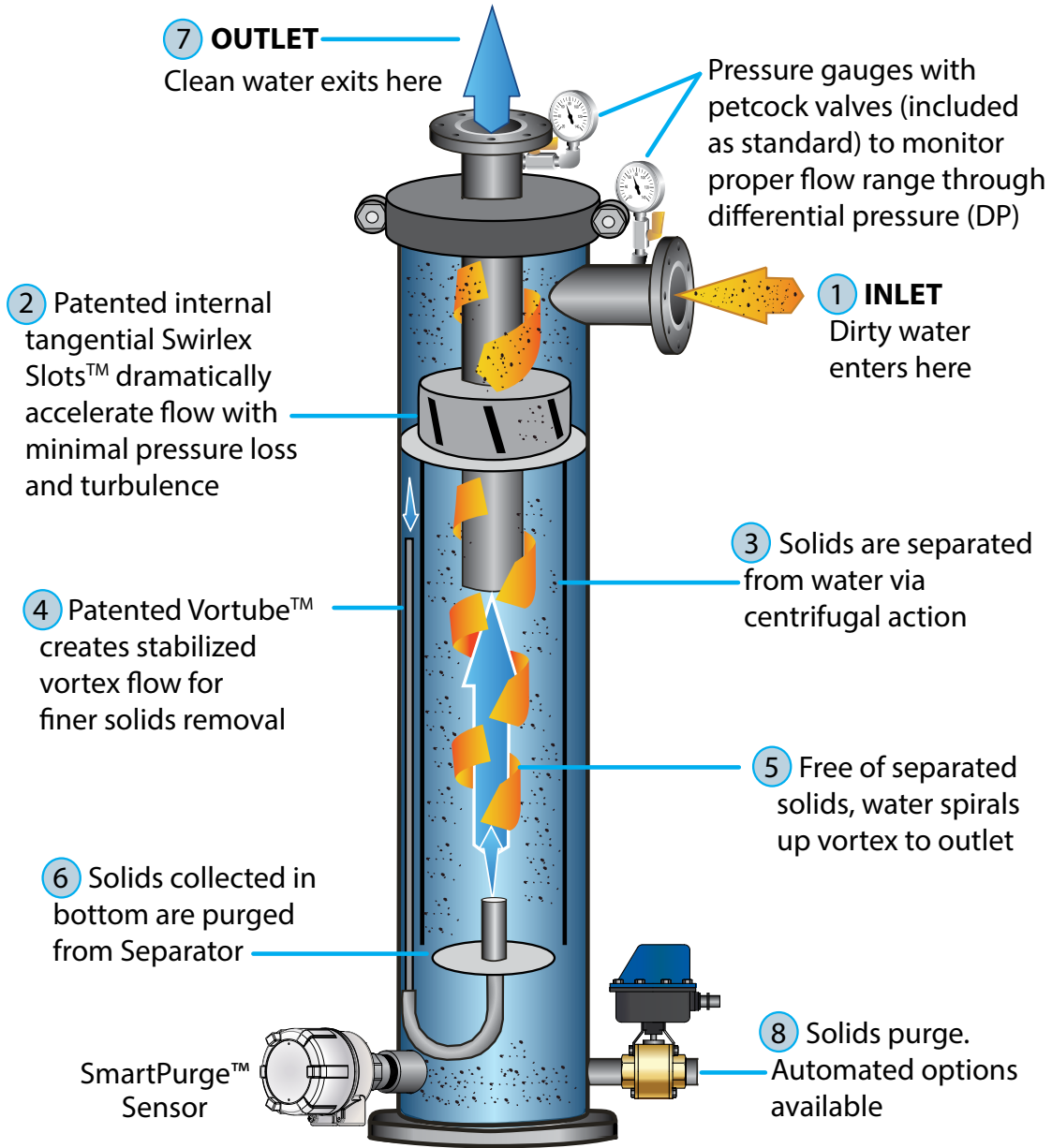

LAKOS eJPX Separators feature improved internals and increased efficiencies as compared to our JPX Separators. To learn more about how our JPX Separators operate, see LAKOS Literature LS-631 and LS-632.

2 PATENTED SWIRLEX SLOT

LAKOS Separators use slots to accelerate liquid and minimize turbulence - allowing highly efficient centrifugal separation of solids from liquids.

3 INTERNAL BARREL

Proprietary lower vortex stabilization methodology further enhances solids separation.

4 PATENTED VORTUBE

Patented Vortube geometry capitalizes on strong pressure gradient present at the center of the vortex to effectively pull finer solids into the collection chamber.

eJPX



Flow Range: 55 - 1,030 U.S. gpm (12.5 - 233 m³/hr)
Maximum Pressure: 250 psi (17.2 bar) w/ ANSI flange
 232 psi (16 bar) w/ DIN flange
 203 psi (14 bar) w/ JIS flange
Max Temperature: 230°F (110° C)
 Consult factory for higher pressures and flow rates
 See pages 10 & 11 for purging options

J-SERIES



Flow Range: 4 - 12,750 U.S. gpm (1 - 2,895 m³/hr)
Maximum Pressure: 150 psi (10.3 bar)
Max Temperature: 185°F (85° C)
 Consult factory for higher pressures
 See pages 10 & 11 for purging options

High Efficiency Liquid-Solid Separators

Liquid-Solid Separators

Features and Benefits:

- Filter performance rated to remove 98% of all solids 44 micron (325 mesh) and larger, 2.6 specific gravity and greater, in a single pass
- Low and steady pressure loss. No backwashing required.
- Continuous uninterrupted filtration and automated purging with SmartPurge™ package (see page 10)

How It Works:

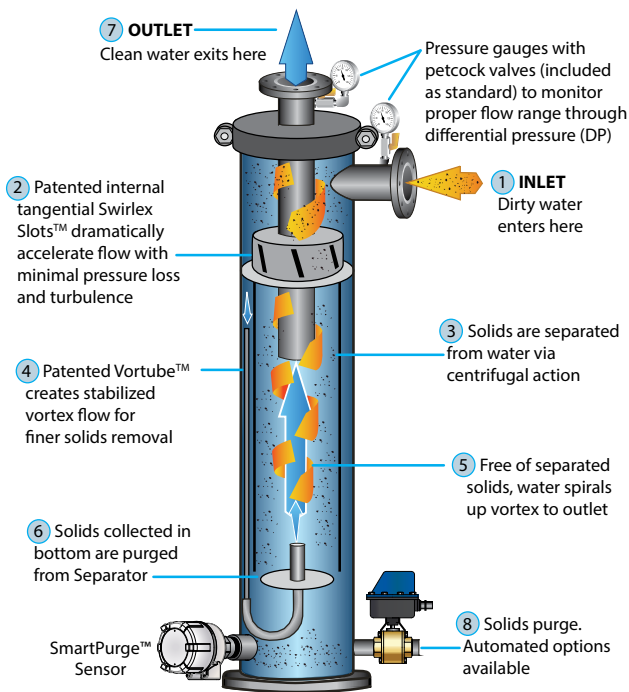

See literature LS-970 for details

Features and Benefits:

- Filter performance rated to remove 98% of all solids 74 micron (200 mesh) and larger, 2.6 specific gravity and greater, in a single pass
- Low and steady pressure loss. No backwashing required.
- Continuous filtration and automated purging with SmartPurge™ package on new installations (see page 10)

How It Works:

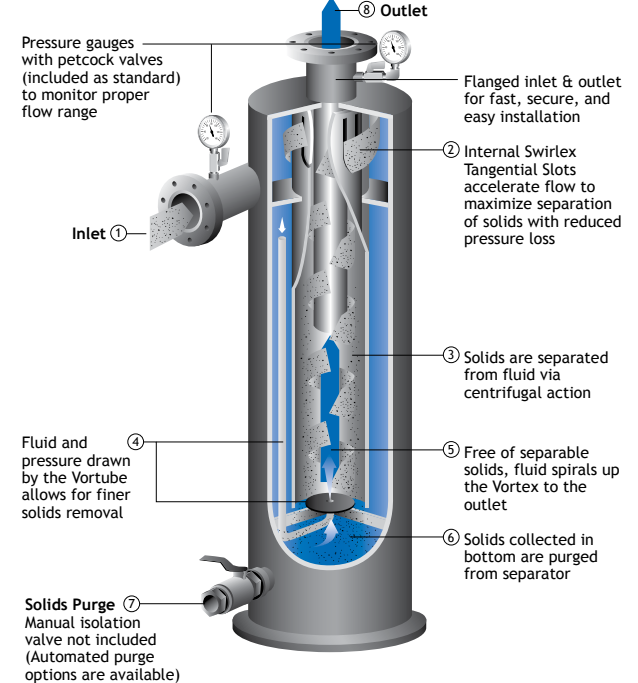

See literature LS-632 and LS-631 for details

PPS Pump Protection Separator



Flow Range: 100 - 3,180 U.S. gpm (23 - 723 m³/hr)

ILB/ILS



Flow Range: 3 - 290 U.S. gpm (.7 - 66 m³/hr)
Maximum Pressure: 150 psi (10.3 bar)

See pages 10 & 11 for purging options

Water Well Sand Damage Control

Features and Benefits:

- Extend the life of submersible and turbine pumps
- Reduce sand damage to pump impellers
- Reduce well sand intrusion in process water supply

How It Works:

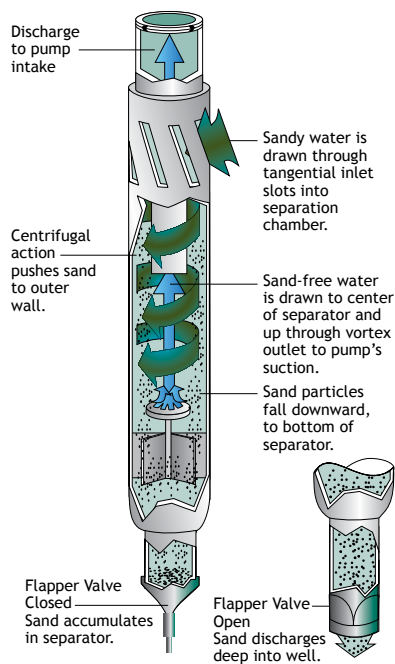

See literature LS-739 for details

Low - Flow, Liquid Solid Separators

Features and Benefits:

- Applicable for low flow and low solids conditions
- Available in stainless and carbon steel
- Ideal for use as testing unit

How It Works:

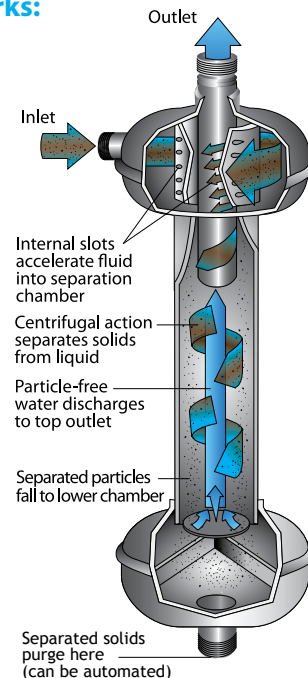

See literature LS-289 for details

JCX & JBX Systems



Flow Range: 100 - 1,200 U.S. gpm (23 - 273 m³/hr)
Maximum Pressure: 150 psi (10.3 bar)
 Consult factory for higher pressures and flow rates
 See pages 10 & 11 for purging options

Packaged Systems for Cooling Tower and Side Stream Applications

PRX System



Flow Range: 4 - 12,750 U.S. gpm (1 - 2,895 m³/hr)
Maximum Pressure: 150 psi (10.3 bar)
 Consult factory for higher pressures and flow rates
 See pages 10 & 11 for purging options

Elevated Separator for Enhanced Solids Handling

Features and Benefits:

- Process cooling tower basin cleaning
- Reduces chemical use
- Side stream cooling tower filtration

JBX System

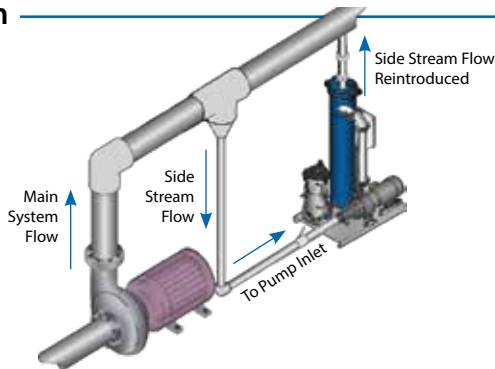

JCX System

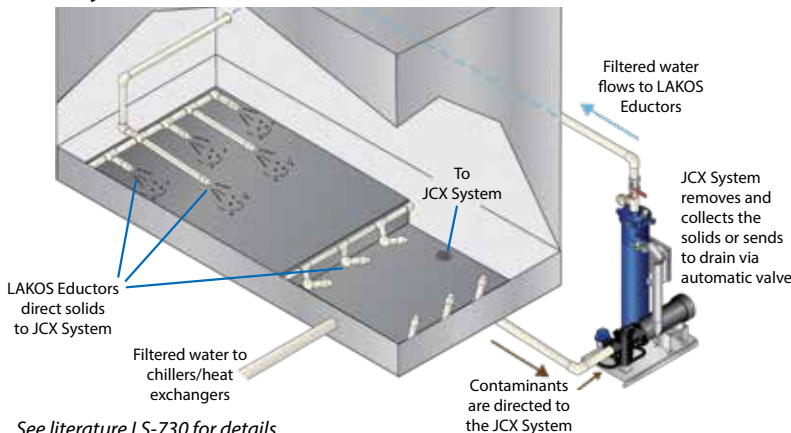

See literature LS-730 for details

Features and Benefits:

- Consolidates solid waste from process flows

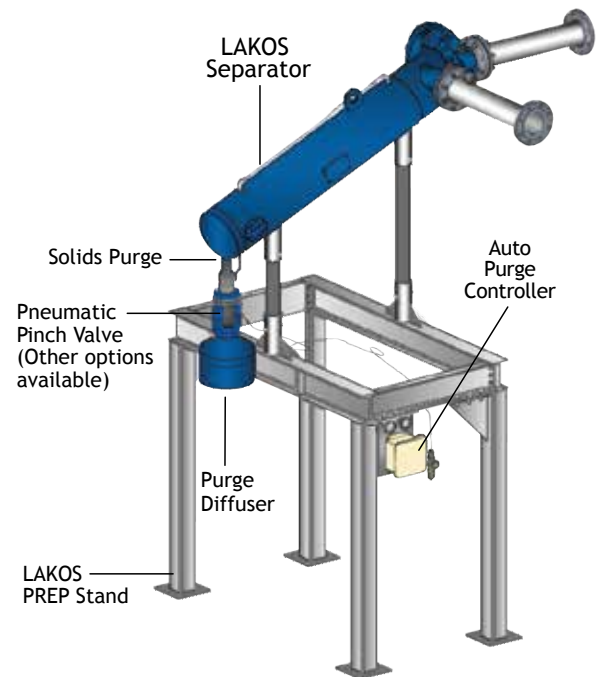

See literature LS-635 for details

Bi-Sep/Tri-Sep Configurations



Flow Range: depends on model
Maximum Pressure: Consult factory

Enhanced Performance Solution

Features and Benefits:

- Increased solids removal efficiency through multiple passes
- Higher solids load handling
- Increased efficiency with finer solids

Boost Filtration Performance with Separators Installed in a Series

If your application includes a higher solids concentration or you wish to remove finer particulates than a single separator will allow, then combining two or more separators and piping them in series is a great option. Any LAKOS J-Series Centrifugal Separator can be configured in this way.

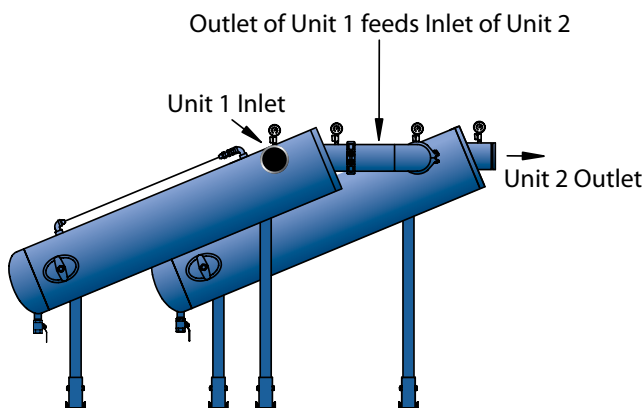

ISF Self Cleaning Pump Intake Screen

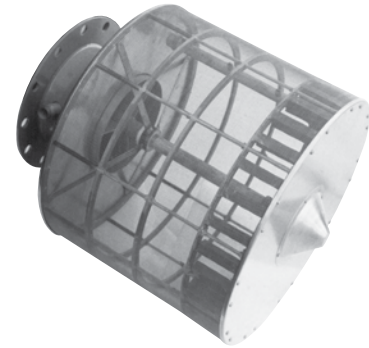

Flow Range: up to 2,700 U.S. gpm (up to 615 m³/hr)

Open Source Water Solution

Features and Benefits:

- Source water from rivers, canals, lakes, etc.
- Protect pumps and other water system components from leaves, algae, moss, sticks, and other troublesome debris

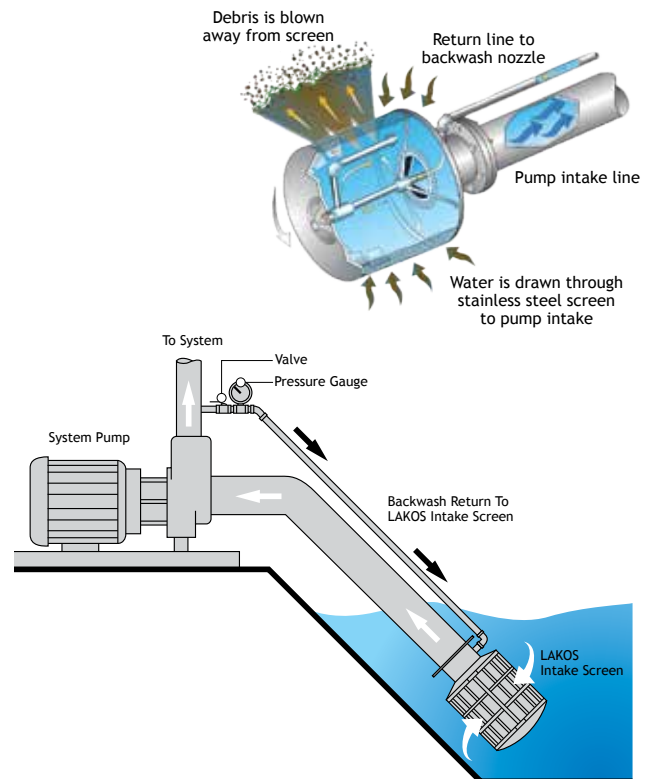

See literature PC-125 for details

Purging and Solids Handling

LAKOS Separators and Systems don't just remove solids from a liquid process, they also help move the solids to another location and efficiently assist in their disposal.



LAKOS SmartPurge™



APP Valve



AKE Valve



AFS Valve



ABV Valve

SmartPurge™ Purge Sensor

LAKOS SmartPurge™ Sensor – detects solids level within the LAKOS eJPX Separator and activates automated purge. More efficient purge cycles leads to labor and energy savings.

- Separator purges only when required, reducing energy costs, fluid loss and maintenance time
- 304 stainless steel
- Vibrating blade tuned to sense changes in solids level within the LAKOS Separator
- Failsafe mode to warn of improper operation
- User adjustable timed purges
- Works with all LAKOS purge accessories

Refer to form LS-972 for details.

Pinch Valves

AutoPurge-Pneumatic Pinch Valves – Preferred technique for durability and abrasive solids. Requires electricity for the programmable controller and compressed air to operate the valve. Refer to form LS-237 for details.

AKE Pinch Valve – Features heavy-wall rubber construction for extended duty in tough applications. Requires electricity for the programmable controller to operate. No compressed air requirement. Refer to form LS-729 for details.

Ball Valves

AutoPurge-Ball Valves – Requires only electricity to actuate the valve according to programmed purge frequency and duration. Refer to form LS-238 for details.

AutoPurge-Fail Safe Pneumatic Ball Valves – Provides the added safety of closing the valve during a power failure. Compressed air and electricity are required. Refer to form LS-356 for details.





Drum Shroud Decant System (SDS)



Custom Solids Handling Systems



Purge Bag Vessel (PBV)



Bag Filter Housing (BFH)



Solids Collection Hopper (SCH) Systems



Purge Diffuser



Purge Liquid Concentrator

Zero Liquid Loss Options for Solids Collection

Accessories

Drum Shroud Decant (SDS) System – Turns a standard 55-gallon drum into a solids concentrating device, capable of 80-90% solids by volume. Unique shroud connects to the drum in order to decant excess purged liquid back to system use. *Solids Capacity: 12,700 cubic inches or 7 cubic feet (200 liters)* Refer to form LS-552 for details.

Solids Collection Hopper (SCH) Systems – Features an easy tilt design for solids discharge and decant connections to return excess purged liquid back to system use. Concentrates solids 80-90%. *Solids Capacity: 1 cubic yard or 27 cubic feet or 46,656 cubic inches (765 liters)* Refer to form LS-556 for details.

Bag Filter Housing (BFH) – A solids collection and fluid recovery system. The BFH captures and concentrates solids in a closed vessel. It can also be used as a prefilter. Refer to form LS-460 for details.

Purge Bag (PBV) Vessel – A closed system with a bag filter to capture and concentrate purged solids. Includes indicator package to identify when bag requires change-out. *Solids Capacity: 360 cubic inches (6 liters)* Refer to form LS-687 for details.

Custom Solids Handling Systems – LAKOS has designed systems involving extra-large containers, screw augers, rail cars, oversize dump trucks and more. Consult factory for special requirements.

Purge Diffusers – When purging into an open vessel, this device prevents excessive splashing. Easily attaches to any LAKOS AutoPurge valve. Refer to form LS-563 for details.

Purge Liquid Concentrators – Significantly reduces liquid loss during purging by as much as 50 times less, providing a very concentrated solids discharge. Fully automated. Refer to form LS-542 for details.



LAKOS In All Industries



Automotive, see literature LS-588

Pre-wash and pre-paint stations, deluge processes, coolant filtration.



Chemical Processing AB-121

Liquid recycling, pre-filtration, waste minimization.



Ethanol, see literature LS-761

Spray nozzle protection, basin scavenging, bacteria control through reduced solids accumulation, heat exchangers, reduced blowdown and chemical usage, energy savings.



Food Processing, see literature LS-630

Bulk pre-washing, process liquid recycling, fry oil reclamation.



Fuel Distribution Systems AB-160

Jet fuel, kerosene, gasoline, pipeline, pre-filtration.



Mining Operations AB-218

Recycling, solids recovery, leach processes.



Municipal Services, see literature LS-849

Source water sand and grit removal, wastewater pre-treatment, water conditioning systems.



Oil and Gas, see literature LS-646

Pump protection, primary and secondary produced water, brine filtration, frac water, disposal wells, secondary recovery, offshore platforms.



Power Plants AB-241

Hydro, Thermal and Gas applications. Protecting pump seals, oil coolers, condensers, heat exchangers and cooling towers.



Primary Metals, see literature LS-740

Quench systems, spray nozzles and descaling operations, hot strip mills, rolling mills, scrap recovery.



Process Cooling, see literature LS-725

Heat exchanger protection, compressor jackets, pump seals, open and closed loop recirculation, heat pumps.



Pulp and Paper Mills AB-240

Plant intake water, black liquor, process recycling.



Vehicle Wash Systems, see literature LS-588

Cars, buses, trucks, trains. Pit/sump scavenging, wash water re-use without detergent/chemical stripping.

Also - industrial laundries, glass and plastics, fire protection systems, wet scrubbers, pump intake screening, water well pump protection and more.

All literature available at www.lakos.com.



These logos are registered trademarks of the companies shown and do not indicate or imply endorsements by these companies.



1365 North Clovis Avenue
Fresno, CA 93727 USA
(559) 255-1601
www.lakos.com • info@lakos.com

LAKOS Separators and Filtration Solutions are manufactured and sold under one or more of the following U.S. Patents: 5,320,747; 5,338,341; 5,368,735; 5,425,876; 5,571,416; 5,578,203; 5,622,545; 5,653,874; 5,894,995; 6,090,276; 6,143,175; 6,167,960; 6,202,543; 7,000,782; 7,032,760 and corresponding foreign patents, other U.S. and foreign patents pending.