

BETE®

PERFORMANCE
THROUGH
ENGINEERING

SPRAY NOZZLES, FABRICATIONS, & SYSTEMS FOR INDUSTRIAL APPLICATIONS



www.bete.com

Table of Contents



With thousands of different spray nozzles available in hundreds of different materials, it's often hard to know where to start. We've incorporated a number of unique charts and other aids into this catalog to simplify your selection process.

Nozzle Selection Guide

There are many ways to select a nozzle. Which way is right for you?

→ BY SPRAY PATTERN....PP. 2-4

Do you know the spray pattern, but not the type of nozzle?.....see pages 2-4

This section introduces you to the types of spray patterns and the spray nozzles available in each.

→ BY APPLICATION....PP. 5-11

Want to see what nozzles excel at your specific application?.....see pages 5-11

An alphabetical list of common applications and the nozzles that are used most frequently for each.

Still not sure? Don't have time to look? **Call us.** BETE Customer Service Representatives and Applications Engineers will listen to your problem and guide you to the nozzle you need. Let our expertise save you time and keep your process running at peak efficiency.

**1-800-235-0049
1-413-772-0846**



www.bete.com

Visit our website to search nozzles by spray pattern, nozzle type, material, and more. Review case studies by industry to learn why BETE solutions lead to our customers' success.



Watch Spray Pattern & Demo Videos
www.youtube.com/c/BETESprayNozzles

Follow BETE

/company/betespraynozzles/

@BETESprayNozzles

@BETE_tweets

@bete_spray

©2019 BETE Fog Nozzle, Inc. All rights reserved.

Cover photography by Greg Bardwell, Greg Garrison, & Eric Amato Photography.

1218USA

*Payment with Visa,
Mastercard and American Express
accepted.*



Alphabetical Nozzle Index

AFF	107
BJ	54, 55
CLUMP	105
CW	Full Cone: 28; Hollow Cone: 44
EZ	Full Cone: 30; Hollow Cone: 46, 47; Fan: 66, 67
FF	64, 65
FINZ	119
HydroClaw	103
HydroPulse	56-59
HydroWhirl Orbitor (HWO)	101
HydroWhirl Orbitor 100	102
HydroWhirl Poseidon (HWP)	100
HydroWhirl S (HWS)	99
IS	116
L	73
LEM	106
LP	117
MaxiPass (MP)	26, 27
MPL	25
MicroWhirl (MW)	70
N	108
NC	34, 35
NCFL	38
NCJ	49
NCK	37
NCS	36
NF	61
NFD	62
NFS	63
NFV	60
P	72
PJ	71
PSR	118
SAM	94, 95
SC	32, 33
SF	Full Cone: 31; Hollow Cone: 48; Fan: 68
Swivel Joint (SJ)	120
SpiralAir (SA)	96, 97
SPN	69
SS	75
ST	22
STXP	23
TC	39
TDL	114
TF	Full Cone: 20; Hollow Cone: 45
TF29-180	109
TFXP	21
TH	50, 51
THW	52, 53
TurboMix (TM)	115
TW	104
Twist & Dry (TD)	110-114
UltiMist (UM)	74
WL	24
WT	40, 41
WTX	42, 43
WTZ	29
XA	76-93

Nozzle Selection Guide	1-12
Alphabetical Nozzle Index	1
Nozzles by Spray Pattern	2-4
Nozzle by Application	5-11

About BETE13-15

Spray Engineering & Systems16-17

Spray Lances & Fabrications18-19

Nozzles - Spray Pattern Types

Full Cone20-39

Hollow Cone40-53

Fan54-69

Misting70-75

Air Atomizing76-97

Tank Washing.....98-106

Special Purpose & Accessories107-121

Technical Information

Materials.....12

Engineering Data122-130

Conversion DataInside Back Cover

**Innovation is a BETE hallmark
and we are proud that
over 60% of the nozzles we ship
have been customized
to meet your needs.**

**If you don't see your nozzle listed,
please call BETE.**

**Special flow rates and angles are
available for most nozzle series.**

Nozzles by Spray Pattern



Full Cone Nozzles

The most frequently used nozzle type in industry is the full cone nozzle. The spray emits from the nozzle in a conical shape with the liquid dispersed over the interior of the cone. When the spray intersects with a surface, a circle of spray is formed with liquid present throughout. The full cone pattern from a spiral nozzle consists of several concentric hollow cones that combine to produce a full cone effect with a smaller droplet size.

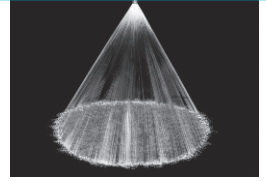

TF

The standard spiral line, available in a wide range of flows, angles, and materials. 1/8" - 4" p. 20



TFXP

Same as the TF plus maximum free passage. 3/8" - 4" p. 21



ST

A Cobalt Alloy tip and 316 stainless connection for spraying abrasive liquids. 1/4" - 4" p. 22



STXP

Same as the ST with extra rugged construction plus maximum free passage. 3/8" - 4" p. 23



WL

Low flow rate, full cone nozzles. 1/8" - 1" p. 24



MPL

Low flow, maximum free passage. Unique, S-shaped internal vanes allow free passage of particles. 1/8" and 1/4" p. 25



MaxiPass

Patented MaxiPass "S"-shaped vanes for superior distribution and largest free passage. 3/8" - 4" pp. 26, 27



CW

Low flow rate full or hollow cone, 3-piece construction with optional strainer and cover. 1/8" - 3/8" p. 28



WTZ

Tangential full cone nozzle with 3-piece construction. 1/4" - 1/2" p. 29



EZ

Quick connection system, ramped engagement for automatic alignment. 1/8" - 1/2" p. 30



SF

Snap release nozzle system features clamp-on adapters for easy installation. 1" - 2" p. 31



SC

Metal full cone nozzles available in a wide range of alloys. 3/4" - 6" pp. 32, 33



NC

Complete line of full cone nozzles available in a variety of plastic materials. 3/4" - 6" pp. 34, 35



NCS

"Stubbies"; short NC-type nozzles for use where space is at a premium. 1" - 4" p. 36



NCK

Narrow spray angle injector. 3/4" - 6" p. 37



NCFL

Large plastic nozzles with high flow rates for applications where flanged connections are required. 4" - 12" p. 38



TC

High capacity full cone metal nozzles. 6" - 12" p. 39

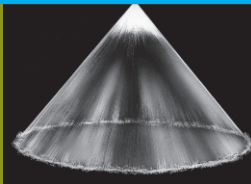

Hollow Cone Nozzles

Used less frequently than full cone nozzles, hollow cone nozzles produce a thin ring of liquid. The spray emits from the nozzle in a conical shape with the liquid only at the periphery of the cone. When the spray intersects with a surface, a ring of spray is formed with a hollow center.

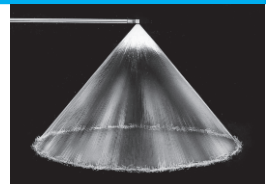

WT

Tangential hollow cone nozzle with 2-piece construction. 1/8" - 3/4" pp. 40, 41



WTX

Similar to WT, with design features for extended life. 1/8" - 3/4" pp. 42, 43



CW

Low flow rate full or hollow cone, 3-piece construction with optional strainer and cover. 1/8" - 3/8" p. 44



TF

The standard spiral line, available in a wide range of flows, angles, and materials. 1/8" - 4" p. 45



EZ

Quick connection system, ramped engagement for automatic alignment. 1/8" - 1/2" pp. 46, 47



SF

Snap release nozzle system features clamp-on adapters for easy installation. 1" - 2" p. 48



NCJ

Narrow spray angle injector. 3/4" - 6" p. 49



TH

Larger one-piece tangential hollow cone nozzle. 1" - 3" pp. 50, 51



THW

Same as TH, with wide spray pattern. 1" - 3" pp. 52, 53



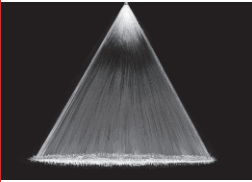

Fan Nozzles

These nozzles produce a thin, flat sheet of liquid that expands outward from the nozzle. A thin line of liquid is produced when the spray intersects a surface. As the liquid is concentrated into a smaller net area, the impact force from fan nozzles is greater than from full or hollow cone nozzles.

BJ

Low flow nozzle with interchangeable tips; fan spray. 1/8" - 3/8"

pp. 54, 55



HydroPulse

Pneumatically actuated low-flow flat fan nozzle with interchangeable tips. 1/8" - 3/8"

pp. 56-59



NFV

Fan nozzle with integral strainer option. 1/8" or 1/4"

p. 60



NF

Standard fan nozzle featuring high impact fan or straight jet spray. 1/8" - 2"

p. 61



NFD

Flat fan nozzle with self-aligning dovetail connection and interchangeable tips. 1/4" - 1 1/4"

p. 62



NFS

Stubby fan nozzle for use where space is at a premium. 1/4" - 2"

p. 63



FF

Deflector-style; extra-wide angle flat fan spray. 1/8" - 1"

pp. 64, 65



EZ

Quick connection system, ramped engagement for automatic alignment. 1/8" - 1/2"

pp. 66, 67



SF

Snap release nozzle system features clamp-on adapters for easy installation. 1" - 2"

p. 68



SPN

Deflector-style; high impact, narrow fan spray. 1/4" - 3/4"

p. 69

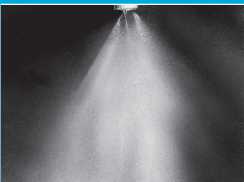

Misting Nozzles

Misting nozzles are characterized by their very small droplet size and relatively small flow rate. The pressure of the incoming fluid is used to drive the atomization process. Higher liquid pressures produce increasingly finer droplets.

MicroWhirl

Low profile and super-fine atomization. 1/8", 1/4", 3/8" - 24UNF

p. 70



PJ

Combines small size and super-fine atomization. 1/8" or 1/4"

p. 71



P

Liquid "impinges" on pin for extra-fine atomization. 1/4"

p. 72

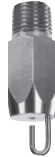

L

A low-flow, spiral nozzle. 1/8" or 1/4"

p. 73



UltiMist

Misting nozzles produce high number of droplets under 60 microns. 1/8" - 1/4"

p. 74



SS

Durable nozzle with multiple fan patterns to provide dense fog. 3/4" - 1 1/4"

p. 75

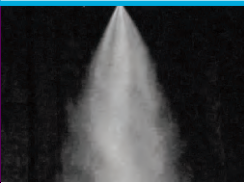

Air Atomizing Nozzles

Compressed gas, most often air, is used to increase the atomization efficiency of these nozzles. A smaller droplet size for a given liquid flow rate can be achieved with the use of compressed air than can be achieved with nozzles that only use the pressure of the fluid.

XA

Two-fluid nozzles for low flow applications. 0.1- 72 GPH

pp. 76-93



SAM

External mix/flat fan or narrow round variable coverage, fine control of droplet size. 0.1-72 GPH

pp. 94, 95



SpiralAir

Two-fluid nozzles for high flow applications. 0.3-20GPM

pp. 96, 97





Tank Washing Nozzles

These specialized products are customized to the task of cleaning the interior surfaces of tanks. The typical 360° spray pattern covers all internal surfaces while specialized 270° and 180° patterns focus the cleaning fluid on specific surfaces. Models range from basic fixed nozzles to advanced fluid-driven tank cleaning machines.

HydroWhirl S

Slotted, rotating tank washing spray nozzle. Available with ATEX approval for Zone 0.
1/8" - 1-1/2"
p. 99



HydroWhirl Poseidon

Rotating tank washing nozzle in PTFE. Ideal for harsh chemical environments.
1/2" - 1-1/2"
p. 100



HydroWhirl Orbitor

High impact rotary tank cleaning machine. 360° and 180° wash patterns. 2 or 4 nozzle configurations



HydroWhirl Orbitor 100

High impact rotary tank cleaning machine ideal for small to medium tanks.



HydroClaw

Unique, clog-resistant design with vigorous 360° rinsing action for food-grade applications.
3/4" - 1-1/2"
p. 103



TW

Compact design; fits small openings. Unique patterns that spray in opposing directions.
3/8" & 1"



CLUMP

A tank washing manifold with 6 large free passage MaxiPass nozzles.
3/4" - 1"



LEM

A special tank washing assembly with omni-directional spray.
3/4" & 1"



Special Purpose Nozzles and Accessories

Applications with very specific requirements require specialized nozzles. Nozzles for fire control, spray drying, submerged tank mixing, the paper industry, and air blowoff are some that require application-specific designs.

FIRE PROTECTION NOZZLES

AFF

FM Approved extra-wide flat fan for fire protection water wall.

3/4" & 1/2"

p. 107



N

Specially designed for fire protection. Factory Mutual, UL, U.S. Coast Guard, and Lloyd's Register approved models.
1/2" - 1 1/2"
p. 108



TF29-180

Ultra-wide fire protection nozzle has full cone spray coverage close to the nozzle
1/2"

p. 109



SPRAY DRYING NOZZLES

Twist & Dry

Stainless steel, FDA-compliant nozzles for food processing and spray drying applications.
1/4" - 3/4"

pp. 110-114



TDL

Stainless steel, FDA-compliant nozzles with low flow rates for food processing and spray drying applications.
1/8" - 3/8"

p. 114



TurboMix

Tank-mixing eductor nozzle. Inherently clog resistant.
3/8" - 8"

p. 115



IS

Mounted in pairs for rectangular coverage.
1/16" - 1 1/2"

p. 116



LP

Self-aligning, interchangeable family of shower nozzles.

p. 117



PSR

Small physical size, hard-driving high velocity, straight jet
9/16" - 24 UNEF
p. 118



FINZ

High-impact air fan nozzle, versatile cleaning nozzle.
1/4"

p. 119



SJ

Swivel joints allow custom alignment of nozzles without piping changes.
1/4" - 3/4"
p. 120



Accessories

Strainers, bushings, adapters, couplings, manifolds, and flanges to complete your installation.

p. 121



Nozzles by Application

Choosing the correct nozzle for your application from BETE's 20,000+ products can be daunting. To help, here is a list of some of the more common uses for spray nozzles. Each application is followed by several BETE nozzle series which have been used in this application. The series used most often is listed first.

The operating pressures, flow rate, and spray angle ranges are typical for each application. The full operating range for each series is generally broader.

If you don't see your application, or need advice making a nozzle selection, please **call us** at 413-772-0846.

Absorption

Scrub hydrofluoric acid, ammonia, and other highly soluble gases

TF 50-100 psi 5-30 gpm 90°-120° p.20	TFXP 50-100 psi 5-30 gpm 90°-120° p. 21	TH 7-15 psi 100-500 gpm 54°-95° SNBSC avail. pp. 50, 51	MaxiPass 7-15 psi 100-500 gpm 90°-120° lumpy liquids pp. 26, 27	NC 7-15 psi 100-500 gpm 90°-120° pp. 34, 35	SC 7-15 psi 100-500 gpm 90°-120° metal nozzle pp. 32, 33
---	--	---	---	--	--

Additives

Apply small volumes of a solution onto moving product or into a mixture

HydroPulse 5-500 psi 0.24-24.7 gpm 0°-110° pp. 56-59	XA 20-60 psi 1.5-25 gph 20°-60° 1- 8.6 scfm pp. 76-93	NF 60-100 psi 0.35-1.6 gpm 65°-120° p. 61	BJ 60-100 psi 0.12-1.6 gpm 50°-80° pp. 54, 55	SAM 10-15 psi 20°-70° 0.44-19 scfm pp. 94, 95
---	---	--	--	--

Aeration

Aerate waste water treatment, fish ponds, and impoundment ponds

TF 20- 40 psi 30- 150 gpm 90°-120° p. 20	TFXP 20- 40 psi 30- 150 gpm 90°-120° lumpy liquids p. 21	MaxiPass 10-40 psi 20-150 gpm 90°-120° lumpy liquids pp. 26, 27
---	--	---

Air and Steam

Clean or dry product moving past nozzle; inject gases and odorants into process lines; sparging; bubbling

NF (D,S) 30- 80 psi 120° 0.5- 75 scfm 0.103-1380 gpm pp. 62,63	FF 30- 80 psi 145° 0.5- 75 scfm 0.014-235 gpm pp. 64, 65	SPN 30- 80 psi 15°- 50° 0.5- 75 scfm 0.5-100 gpm p. 69
--	--	--

Air Conditioning

Cooling air at gas turbine inlets

PJ 60- 1000 psi 0.01- 1.4 gpm 90° p. 71	XA 30- 60 psi 20°-60° 0.5- 14 scfm pp. 76-93	MicroWhirl 100-3000 psi 0.009-0.151 gpm 20°-70° p. 70
--	---	--

Air Nozzle

Blowoff nozzle uses compressed air only

FINZ 10- 90 psi 4- 41 scfm p. 119

Blowoff Nozzles

Remove water or dust from strips and conveyors

NF 30- 80 psi 120° 0.5- 75 scfm p. 61	FF 30- 80 psi 120° 0.5- 75 scfm pp. 64, 65	SPN 30- 80 psi 120° 0.5- 75 scfm p. 69	FINZ 10- 90 psi 4- 41 scfm p. 119
--	---	---	---

Color Code:

- Full Cone
- Hollow Cone
- Fan
- Misting
- Air Atomizing
- Tank Washing
- Special Purpose

Car Wash Nozzles

High pressure wash nozzles used in automated car wash units.

NF 40- 60 psi 1.0- 102 gpm 120° p. 61	FF 40- 60 psi 1.0-102 gpm 105°-145° pp. 64, 65	SPN 40- 60 psi 1.0-102 gpm 35°- 50° p. 69
--	---	--

Clean in Place Nozzles

Rotating and stationary bottle, drum, and tank washing nozzles

HydroWhirl S 10-60 psi 1.26-90.9 gpm 360° efficient clean p. 99	HydroWhirl Poseidon 10-60 psi 50.3-89.5 gpm 360° PTFE p. 100	HydroWhirl Orbitor 45-145 psi 21.5-160 gpm 180°, 360° high-impact p. 101	HydroWhirl Orbitor 100 45-145 psi 12-52.4 gpm 180°, 360° high-impact p. 102	HydroClaw 25-40 psi 33-112 gpm 360° clog-resistant p. 103	TW 30- 60 psi 5.2- 63.0 gpm 180°- 270° very compact p. 104
---	--	--	---	---	--

Clog-resistant Nozzles

Wide free passage to spray lumpy, viscous liquids with less clogging

MaxiPass 3- 80 psi 0.7- 938 gpm 30°-120° lumpy liquids pp. 26, 27	TFXP 10- 400 psi 3-3320 gpm 90°-120° lumpy liquids p. 21	TH 3-40 psi 4.1- 564 gpm 54°-95° SNBSC avail. pp. 50, 51	WTZ 5- 100 psi 0.18-15.4 gpm 90°-110° p. 29	SPN 10- 200 psi 0.5- 44.7 gpm 15°-50° p. 69	FF 3- 200 psi 0.014-235 gpm 145° pp. 64, 65
---	--	--	--	--	--

Coating

Apply thin coatings (wet or dry) on product moving past nozzles

HydroPulse 5-500 psi 0.24-24.7 gpm 0°-110° pp. 56-59	XA 20- 60 psi 2.9- 70 gph 20° 0.4-10 scfm pp. 72-89	NF (D,S) 30- 80 psi 0.22- 17 gpm 50°-120° pp. 58, 59	BJ 30- 80 psi 0.09- 10 gpm 25°-80° pp. 54, 55	PJ 60- 100 psi 0.014- 0.44 gpm 90° p. 67	L 40- 100 psi 0.28- 1.18 gpm 90° p. 69	SAM 10-15 psi 20°-70° 0.44- 19 scfm pp. 90, 91
---	---	---	--	---	---	---

Concrete Curing

Humidify concrete to control curing process

XA 30- 60 psi 0.4- 30 gph 20°- 70° 0.6- 17 scfm pp. 76-93	PJ 60- 100 psi 0.014- 1.4 gpm 90° p. 71	MicroWhirl 100-3000 psi 0.009-0.151 gpm 20°-70° p. 70
---	--	--

Cooling: Deluge

Process cooling for food, chemical, and industrial processes

TF 10- 20 psi 12-250 gpm 90°-120° p. 20	MaxiPass 3-20 psi 6-240 gpm 90°-120° lumpy liquids pp. 26, 27	WL 5-20 psi 0.5- 14 gpm 80°-120° p. 24	NC 3-20 psi 6-240 gpm 90°-120° pp. 34, 35	TC 1-60 psi 217-8730 gpm 60°, 90°, 120° p. 39
--	---	---	--	--

Cooling: Evaporative

Cool hot (+ 300°F) flue gases prior to entering a baghouse or temperature-sensitive equipment

SpiralAir 40- 100 psi 0.33- 18 gpm 20°-60° 25- 137 scfm pp. 96, 97	TF -full 60- 150 psi 1.6- 18 gpm 90°-120° p. 20	TF -hollow 60- 150 psi 1.6- 18 gpm 90°-120° p. 45	TFXP 60-150 psir 1.6- 18 gpm 90°-120° lumpy liquids p. 21	L 60- 200 psi 0.33- 5.6 gpm 90° p. 73	P 60- 200 psi 0.33- 5.6 gpm 90° p. 72	XA 20- 60 psi 2.9- 26 gph 20°-60° 0.8-12 scfm pp. 76-93	MicroWhirl 100-3000 psi 0.009-0.151 gpm 20°-70° p. 70
--	--	--	---	--	--	---	--

Cooling: Parts

Cool hot parts on conveyors from pre-treatment ovens

MaxiPass 10- 60 psi 1.25- 219 gpm 90°-120° lumpy liquids pp. 26, 27	WL 10- 60 psi 0.13-24.2 gpm 90°-120° p. 24	SC 10- 60 psi 2.96- 165 gpm 90°-120° metal nozzle pp. 32, 33	TFXP 10- 60 psi 0.7- 158 gpm 90°-120° p. 21	TF 10- 60 psi 0.7- 158 gpm 90°-120° p. 20	MPL 10- 80 psi 0.12-2.03 gpm Narrow-Wide p. 25
---	---	--	--	--	---

Cooling: Pond

Cool pond water; heat recovery

TFXP 7-15 psi 20- 120 gpm 90°-120° lumpy liquids p. 21	TF -full 7-15 psi 20- 120 gpm 90°-120° p. 20	TF -hollow 7-15 psi 20- 120 gpm 90°-120° p. 45	TH 3- 15 psi 16-90 gpm 80°-100° pp. 50, 51	MaxiPass 10- 20 psi 6- 90 gpm 90° pp. 26, 27
--	---	---	---	---

Debarking

Remove bark from logs prior to pulping

NF	SPN
0- 1000 psi 75- 1380 gpm 30°-90° p. 61	1000 psi 20- 100 gpm 35°-50° p. 69

Disposal:

Evaporative
Evaporate tailing ponds or volatile waste

TFXP	TF -full	TF -hollow	MaxiPass
40- 120 psi 2.6- 70 gpm 90°-120° lumpy liquids p. 21	40- 120 psi 2.6- 70 gpm 90°-120° p. 20	40- 120 psi 2.6- 70 gpm 90°-120° p. 45	40- 120 psi 5.6- 65 gpm 90°-120° lumpy liquids pp. 26, 27

Distribution

Distribute fluids uniformly onto packing, trickle bed media, and horticultural beds; VOC stripping

NC	SC	MaxiPass	TC	IS	WL
3-20 psi 3-3500 gpm 90°-120° plastic nozzle pp. 34, 35	3- 20 psi 2-422 gpm 90°-120° metal nozzle pp. 32, 33	3- 20 psi 1-510 gpm 90°-120° lumpy liquids pp. 26, 27	1- 10 psi 217- 3500 gpm 60°-120° p. 39	0.5-10 psi 0.5-115 gpm used in pairs lumpy liquids p. 116	5-20 psi 1.1- 15 gpm 90°-120° p. 24

Drying

Remove excess water after washing or rinsing

NF	FF	SPN	FINZ
40- 80 psi 0.4- 50 scfm p. 61	40- 80 psi 0.2- 50 scfm pp. 64, 65	40- 80 psi 0.4- 50 scfm p. 69	10- 90 psi 4- 41 scfm p. 119

Dust Control:

Air-handling Ducts
Suppress stone, coal and other dust in vent ducts; control paint spray carry-over

TF	TFXP	MaxiPass	L	P	SpiralAir	MicroWhirl
30- 80 psi 1.2-11.4 gpm 90°-150° p. 20	30-80 psi 5.2- 11.4 gpm 90°-120° lumpy liquids p. 21	40- 80 psi 2.4-12.5 gpm 90°-120° lumpy liquids pp. 26, 27	40- 80 psi 0.28-3.42 gpm 90° very fine dust p. 73	40- 80 psi 0.067-3.83 gpm 90° very fine dust p. 72	40- 100 psi 0.33- 18 gpm 20°-60° 25- 137 scfm pp. 96, 97	100-3000 psi 0.009-0.151 gpm 20°-70° p. 70

Dust Control:

Area
Suppress dust at conveyor transfer points, dump pits, and loading hoppers

TF	TF150	MaxiPass	TFXP	TF170	L
30- 80 psi 1.2-11.4 gpm 90°-120° p. 20	30-80 psi 5.2- 11.4 gpm 150° wide coverage p. 20	40- 80 psi 2.4-12.5 gpm 90°-120° lumpy liquids pp. 26, 27	30- 80 psi 1.2-11.4 gpm 90°-120° lumpy liquids p. 21	30- 80 psi 5.2-15 gpm 170° wide coverage p. 20	40- 100 psi 0.28-3.83 gpm 90° transfer point p. 73

Etching:

Electronics
Wash and rinse circuit boards and wafers

WL	NF (D,S)	SPN	FF
10- 40 psi 0.12- 43 gpm 60°-120° p. 24	10-40 psi 0.12- 7 gpm 50°-120° pp. 62, 63	10- 40 psi 0.5- 4 gpm 35°-50° p. 69	3- 20 psi 0.014-3.8 gpm 145° pp. 64, 65

EZ Change/ 1/4 Turn Nozzles

Quick change-out nozzle base assembly with 1/4-turn ramped engagement

EZ_{FF, NF, SPN}	EZ_{WL, TF}	EZ_{WL, TF, WT}
5- 500 psi 0.02-43 gpm 0°-145° pp. 66, 67	5- 500 psi 0.02- 58 gpm 30°-120° p. 30	5- 500 psi 0.02- 58 gpm 30°-120° p. 46

Color Code:

- Full Cone
- Hollow Cone
- Fan
- Misting
- Air Atomizing
- Tank Washing
- Special Purpose

Fire Protection:

Deluge

Protect offshore platforms, storage tanks, hazardous loading areas, and equipment bays

N 60- 150 psi 52- 340 gpm 90°-120° FM approved p. 108	TFXP 60- 150 psi 52- 300 gpm 90°-120° lumpy liquids p. 21	MaxiPass 60- 120 psi 47- 178 gpm 90°-120° lumpy liquids pp. 26, 27	TF150 60- 150 psi 52- 300 gpm 150° wide coverage p. 20
---	---	--	--

Fire Protection:

Special

Protect coal conveyors; fueling and vulcanizing cabinets; warehouses and munitions storage

N 50- 150 psi 52- 340 gpm 90°-120° FM approved p. 108	TF29-180 50- 150 psi 52- 300 gpm 180° wide coverage p. 109	SpiralAir 40- 100 psi 0.3- 19 gpm 20°-40° 23- 115 scfm pp. 96, 97	CW 40- 200 psi 116- 327 gpm 80°-120° p. 28
---	--	---	---

Fire Protection:
Water Wall

Protect personnel, evacuation muster areas, equipment, and structures from heat radiation

AFF 50- 150 psi 6.72-69.7 gpm 135°-144° FM approved p. 107	TF 60- 150 psi 52- 300 gpm 90°-120° p. 20	TF150 60- 150 psi 52- 300 gpm 150° wide coverage p. 20	TF170 60- 150 psi 52- 300 gpm 170° horiz. spray p. 20	NF (D,S) 60- 120 psi 20-195 gpm 90°-120° pp. 62, 63	FF 20- 80 psi 17- 150 gpm 145° wall wetting pp. 64, 65	TFXP 60- 150 psi 52- 300 gpm 90°-120° lumpy liquids p. 21
--	--	--	---	--	--	---

Foam Control

Control build-up of foam in aeration and settling basins; mixing vessels and below weirs; and spillways

MaxiPass 3- 15 psi 1.5- 115 gpm 90°-120° lumpy liquids pp. 26, 27	WL 5- 20 psi 2.8- 14.1 gpm 90°-120° p. 24	SC 3- 20 psi 1.7- 98 gpm 90°-120° pp. 32, 33	TFXP 7- 20 psi 40- 120 gpm 90°-120° lumpy liquids p. 21
---	--	---	---

Fog Nozzles

Fine atomization misting; movie special effects

PJ 60- 200 psi 0.014- 0.63 gpm 90° p. 71	TF -full 10- 100 psi 1- 20 gpm 90°-120° full cone p. 20	TF -hollow 10- 100 psi 1- 20 gpm 90°-120° hollow cone p. 45	XA 10- 60 psi 0.3- 29 gph 20°-40° pp. 76-93	UltiMist 500- 2000 psi 0.5- 7 gpm 100°- 110° p. 74	MicroWhirl 100-3000 psi 0.009-0.151 gpm 20°-70° p. 70
---	---	---	--	---	--

Food Processing

Applying flavorants or colorants

HydroPulse 5-500 psi 0.24-24.7 gpm 0°-110° pp. 56-59	XA 10- 100 psi 0.4- 60 gph 60°-120° pp. 76-93	FF 10- 80 psi 0.25- 5 gpm 145° pp. 64, 65
---	--	--

Gas Scrubbing

Spray reagent into gas

STXP 5- 15 psi 60-650 gpm 90°-120° recycle slurry p. 23	ST 5- 15 psi 60- 650 gpm 90°-120° resist erosion p. 22	MaxiPass 3- 20 psi 52- 510 gpm 90°-120° recycle slurry pp. 26, 27	TH 3- 30 psi 45- 610 gpm 90°-120° SNBSC avail. pp. 50, 51	NC 3- 20 psi 11- 422 gpm 90°-120° plastic nozzle pp. 34, 35	SC 3- 20 psi 24- 345 gpm 90°-120° metal nozzle pp. 32, 33
---	--	---	---	---	---

Humidification

Humidify air in ducts, drying kilns, curing rooms, greenhouses, and other open areas; area misting

XA 30- 60 psi 0.4- 60 gph 20°-40° 0.6- 17 scfm pp. 76-93	PJ 60- 200 psi 0.014- 0.63 gpm 90° p. 71	TF 80- 200 psi 2- 6 gpm 120° hollow cone p. 20	L 80- 200 psi 2- 6 gpm 90° p. 73	SpiralAir 60- 100 psi 0.3- 15 gpm 20°-60° 71-186 scfm pp. 96, 97	MicroWhirl 100-3000 psi 0.009-0.151 gpm 20°-70° p. 70
--	---	--	---	--	--

Large Free Passage Nozzle

Clog resistant; allow lumpy viscous liquids to pass easily

MaxiPass 3- 80 psi 0.74- 938 gpm 30°-120° pp. 26, 27	TFXP 10- 400 psi 3-3320 gpm 90°- 120° p. 21	TH 3-40 psi 4-564 gpm 90°-120° SNBSC avail. pp. 50, 51
---	--	--

Lubrication

Lubricate dies and moulds; roll bite in strip mills

XA
20- 60 psi
1.5- 25 gph
20°-60°
1.0- 8.6 scfm
pp. 76-93

NF (D,S)
60- 100 psi
0.4- 2 gpm
65°- 120°
pp. 62, 63

BJ
60- 1000 psi
0.1- 2 gpm
50°- 80°
pp. 54, 55

HydroPulse
5-500 psi
0.24-24.7 gpm
0°-110°
pp. 56-59

Color Code:

■ Full Cone

■ Hollow Cone

■ Fan

■ Misting

■ Air Atomizing

■ Tank Washing

■ Special Purpose

Mist Eliminator Wash

Clean mist eliminators in packed or open tower scrubbers

NC
20- 50 psi
3- 40 gpm
90°
pp. 34, 35

MaxiPass
20- 50 psi
3- 40 gpm
90°
pp. 26, 27

WL
2- 50 psi
0.25- 10 gpm
90°-120°
p. 24

Misting

Moisten paper; mist produce; compost piles of crushed products

UltiMist
500- 2000 psi
0.5- 7 gpm
100°- 110°
p. 74

PJ
100- 2000 psi
0.04- 1 gpm
90°
p. 71

XA
40- 100 psi
0.7- 100 gph
60°-120°
pp. 76-93

TF -full
40- 400 psi
1- 20 gpm
90°- 120°
p. 20

TF -hollow
10- 100 psi
1- 20 gpm
90°-120°
hollow cone
p. 45

MicroWhirl
100-3000 psi
0.009-0.151 gpm
20°-70°
p. 70

Mixing Eductors

Keep solids suspended by eduction

TurboMix
10- 100 psi
7- 12700 gpm
p. 115

Moistening

Wetting, humidifying products on conveyor

XA
40- 100 psi
0.4- 100 gph
60°-120°
pp. 76-93

PJ
100- 200 psi
0.04- 1 gpm
90°
p. 71

LP
60- 500 psi
0.05- 44 gpm
0°-60°
p. 117

MicroWhirl
100-3000 psi
0.009-0.151 gpm
20°-70°
p. 70

HydroPulse
5-500 psi
0.24-24.7 gpm
0°-110°
pp. 56-59

Odor Control

Spray odor neutralizing agents

XA
20-60 psi
0.5-30 gph
pp. 76-93

PJ
100-2000 psi
0.1-1.0 gpm
90°
p. 71

MicroWhirl
100-3000 psi
0.009-0.151 gpm
20°-70°
p. 70

SpiralAir
40- 100 psi
0.3- 19 gpm
20°-40°
23- 115 scfm
pp. 96, 97

Packing

Distribute scrubbing liquor in scrubbers or water in humidifiers

NC
3- 20 psi
3- 3500 gpm
120°
plastic nozzle
pp. 34, 35

SC
3- 20 psi
2- 422 gpm
90°-120°
metal nozzle
pp. 32, 33

MaxiPass
3- 20 psi
1- 510 gpm
90°- 120°
lumpy liquids
pp. 26, 27

TC
1- 10 psi
217- 3500 gpm
60°-120°
metal nozzle
p. 39

IS
0.5- 10 psi
0.5- 115 gpm
used in pairs
lumpy liquids
p. 116

WL
20- 50 psi
0.25- 10 gpm
90°-120°
p. 24

Pollution Control

Distribute slurry in open towers

STXP
5- 15 psi
60- 650 gpm
90°-120°
RBSC available
p. 23

ST
5- 15 psi
60-650 gpm
90°-120°
RBSC available
p. 22

MaxiPass
3- 20 psi
52- 510 gpm
90°-120°
recycle slurry
pp. 26, 27

TH
3- 30 psi
45- 610 gpm
90°-120°
SNBSC avail.
pp. 50, 51

NC
3- 20 psi
11- 422 gpm
90°-120°
plastic nozzle
pp. 34, 35

SC
3- 20 psi
24- 345 gpm
90°-120°
metal nozzle
pp. 32, 33

Pulp Bleaching

Wall wash
bleaching tanks

FF 20- 60 psi 0- 50 gpm 105°-145° pp. 64, 65	NF 40- 100 psi 1- 10 gpm 20°-60° p. 61
---	---

Quench

Evaporatively quench
hot gases

SpiralAir 30- 100 psi 0- 50 gpm 21-112 scfm 20°-90° pp. 96, 97	XA 30- 60 psi 0.4- 30 gph	L 80- 200 psi 0.4- 1.8 gpm 90° p. 73	TF -full 40- 400 psi 1- 20 gpm 90°- 120° p. 20	TF -hollow 10- 100 psi 1- 20 gpm 90°-120° hollow cone p. 45	PJ 60- 200 psi 0.007-0.63 gpm 90° p. 71	MicroWhirl 100-3000 psi 0.009-0.151 gpm 20°-70° p. 70
--	--	---	---	---	--	--

Roll Cooling

Cool rolls in steel
strip mills

NF (D,S) 40- 100 psi 0.5- 10 gpm 60°-120° pp. 62, 63

Scrubbing:

Conditioning

Inject ammonia or water
upstream of electrostatic
precipitators; inject odor
control additives

XA 30- 60 psi 0.4- 30 gph 20°-40° 0.8-22 scfm pp. 76-93	PJ 60- 200 psi 0.014- 0.63 gpm 90° p. 71	L 80- 200 psi 0.4- 1.8 gpm 90° p. 73	SpiralAir 60- 100 psi 0.3- 15 gpm 20°-60° 49-124 scfm pp. 96, 97	MicroWhirl 100-3000 psi 0.009-0.151 gpm 20°-70° p. 70
---	--	---	--	--

Scrubbing:

Direct Contact

Spray water or reagent
slurry into open tower;
flue gas desulphurization

STXP 5- 15 psi 60- 650 gpm 90°-120° recycle slurry p. 23	ST 5- 15 psi 60- 650 gpm 90°-120° resist erosion p. 22	MaxiPass 3- 20 psi 52- 510 gpm 90°-120° recycle slurry pp. 26, 27	TH 3- 30 psi 45- 610 gpm 90°-120° SNBSC avail. pp. 50, 51	NC 3- 20 psi 11- 422 gpm 90°-120° plastic nozzle pp. 34, 35	SC 3- 20 psi 24- 345 gpm 90°-120° metal nozzle pp. 32, 33	TF 5- 15 psi 60- 650 gpm 90°- 120° p. 20
--	--	---	---	---	---	---

Scrubbing:

Dry

Inject lime slurry; inject
food and chemical prod-
uct into spray dryer

SpiralAir 50- 100 psi 1.4- 15 gpm 20°-60° 37-186 scfm pp. 96, 97	XA 40- 60 psi 0.7- 44 gph 20°-40° 1.5-22 scfm pp. 76-93	WT 60- 150 psi 0.12- 15 gpm 80°-130° pp. 40, 41	WTX 60- 150 psi 0.12- 15 gpm 70°-140° pp. 42, 43
--	---	--	---

Self Cleaning

Nozzles/ Showers

Clean webs in paper
mills, wash or rinse steel
strip or conveyor belts

LP 5- 500 psi 3.5- 1000 gpm 30°- 60° p. 117
--

Spray Drying

Processing of milk, other
foods and chemical
products

TD 200- 3500 psi 8.9- 1570 gph 50°- 80° pp. 110-114	TD-K 3500-10000 psi 70°-75° pp. 112, 113	TDL 15- 40 psi 4.2- 30 gph 70°-75° p. 114	SpiralAir 30- 100 psi 0.3- 20 gpm 37-115 scfm 20°-90° pp. 96, 97
--	--	--	--

Street Flushing & Cleaning

High impact wash down,
clear loose debris from
streets; walkways

FF 20- 100 psi 20- 105 gpm 145° wide coverage pp. 64, 65	SPN 20- 100 psi 2- 20 gpm 15°-50° high impact p. 69	NF 20- 1000 psi 20- 200 gpm 50°-90° p. 61
--	---	--

Washing:
Conveyor
 Wash coal, sand, gravel, and crushed rock; pre-wet to reduce dust at hoppers and transfer points

NF (D,S)	SPN	FF	MaxiPass	TFXP	L
5- 60 psi 1.4- 449 gpm 65°-120° pp. 62, 63	10- 80 psi 2- 28 gpm 15°-50° high impact p. 69	3- 60 psi 0.4- 29 gpm 145° wide coverage pp. 64, 65	3- 40 psi 0.68- 38 gpm 60°-120° lumpy liquids pp. 26, 27	7- 40 psi 2.8- 42 gpm 90°-120° lumpy liquids p. 21	40- 60 psi 0.28- 3 gpm 90° transfer point p. 73

Washing:
Intermittent
 Periodic wash down of mist eliminator, filter pads, sieve screens, and distribution plates

NC	MaxiPass	WL	SC
15- 40 psi 4.2- 30 gpm 60°-120° plastic nozzle pp. 34, 35	20- 60 psi 1.7- 15.8 gpm 60°-120° lumpy liquids pp. 26, 27	20- 80 psi 0.18- 28 gpm 80°-120° p. 24	15- 40 psi 4.5- 32 gpm 60°-120° metal nozzle pp. 32, 33

Washing:
Parts
 High impact parts washing and surface preparation

NF (D,S)	SPN	WL	NC	SC	SF
20- 80 psi 0.18- 28 gpm 65°-120° pp. 62, 63	10- 80 psi 2- 28 gpm 15°-50° high impact p. 69	10- 60 psi 0.37- 24.5 gpm 90°-120° p. 24	10- 40 psi 3.6- 38 gpm 60°-120° plastic nozzle pp. 34, 35	10- 40 psi 3- 44 gpm 60°-120° metal nozzle pp. 32, 33	20- 80 psi 0.7- 16 gpm 35°-95° pp. 68

Washing:
Tank
 Rinsing and solvent cleaning of tanks, drums, and process equipment

HydroWhirl S	HydroWhirl Poseidon	HydroWhirl Orbitor	HydroWhirl Orbitor 100	HydroClaw	TW	CLUMP	LEM
10-60 psi 1.26-90.9 gpm 360° efficient clean p. 99	10-60 psi 50.3-89.5 gpm 360° PTFE p. 100	45-145 psi 21.5-160 gpm 180°, 360° high-impact p. 101	45-145 psi 12-52.4 gpm 180°, 360° high-impact p. 102	25-40 psi 33-112 gpm 360° clog-resistant p. 103	30- 60 psi 5.2- 63.0 gpm 180°- 270° very compact p. 104	40-60 psi 13.8- 68 gpm 360° lumpy liquids p. 99	40- 60 psi 8.4- 121 gpm 360° even rinsing p. 100

Venturi Scrubbing
 Keep solids suspended by injection

NCK	NCJ
10-100 psi 7.1-1220 gpm 30° p. 37	10-100 psi 7.1-1220 gpm 30° p. 49

Color Code:

- Full Cone
- Hollow Cone
- Fan
- Misting
- Air Atomizing
- Tank Washing
- Special Purpose

MATERIALS

BETE manufactures nozzles in hundreds of different materials and combinations of materials. The chart on this page shows the 40 materials most often specified. If you don't know which material is best for your application, BETE Applications Engineering can help you with your selection. Some factors that influence the nozzle material selection process are:

Temperature. Melting or softening of material establishes maximum temperature limits. However, these temperature limits must be reduced when corrosion, oxidation, or chemical attack are also present. See column in blue for general temperature limits for various materials.

Corrosion. Plastics offer superior corrosion resistance at relatively low cost, but can only be used in low-temperature applications. In general, metals can be ranked in the following order of corrosion resistance (from lowest to highest): cast iron, brass, stainless steels, nickel-based alloys, refractory metals and precious metals. Ceramics have excellent corrosion resistance except in very high pH environments.

Chemical attack. There are few general guidelines to this complex subject, but the material used for piping may provide a useful indicator of a suitable nozzle material.

If the environment of your application is known to contain substances which may attack the spray

nozzle, contact BETE Applications Engineering for advice.

Abrasion. Hardened stainless steel, Cobalt Alloy 6, tungsten carbide, and ceramics are commonly used in applications where abrasive fluids are sprayed.

Cost. There are exceptions, but materials can generally be ranked in the following order in terms of cost (from lowest to highest): brass, stainless or carbon steel, plastics, stainless steels, cobalt-base alloys, nickel-base alloys, ceramics, refractory metals and precious metals.

Material Description	BETE Material No. (MN)	(DIN) Description	Temp. Rating (° F)	Trade Name*
Brass	4	Messing	450°	
Naval Brass	64		750°	
Bronze		Bronze	750°	
L.C. Steel	72	C-Stahl	400°	
303	5	1.4305	800°	
304	6	1.4301	800°	
304L		1.4306	800°	
316	7	1.4401	800°	
Tungsten Carbide	7H			
Alumina	26			
316L	20	1.4404	800°	
317	21	1.4440	800°	
317L	22	1.4438	800°	
416	24	1.4005	800°	
904L	74	1.4539	800°	
Alloy 20	70	2.4660	900°	Carpenter® 20
Nickel Alloy M30C	37	2.4360/2.4366	1000°	Monel®
Nickel Alloy 600	35	2.4816	2000°	Inconel® 600
Nickel Alloy 625	3B	2.4856	2000°	Inconel® 625
Nickel Alloy 800	33	1.4876	1850°	Incoloy® 800
Nickel Alloy 825	34	2.4858	1850°	Incoloy® 825
Nickel Alloy B	31	2.4800/2.4810	1400°	Hastelloy® B w/2.5 Max. Co
Nickel Alloy G	32	2.4619	2000°	Hastelloy® G
Nickel Alloy G30	49	2.4603	2000°	Hastelloy® G30
Nickel Alloy C276	81	2.4819	2000°	Hastelloy® C276
Nickel Alloy C22	2A	2.4602	2000°	Hastelloy® C22
Nickel	38	Nickel	650°	
Titanium	11	Titan	900°	
Tantalum	40	Tantal	2700°	
Zirconium	61	Zirkonium	1000°	
Cobalt Alloy 6	9		1900°	Stellite® 6
SNBSC ceramic	62		3000°	Refrax®
RBSC ceramic	59		2500°	
PTFE	3	PTFE	300°	Teflon®
PVDF	36	PVDF	245°	Kynar®
PVC	1	PVC	135°	
CPVC	16	CPVC	180°	
Polypropylene	2	Polypropylen	155°	
UHMW	17		180°	
Polyurethane	69		176°	
ABS	15		155°	

* BETE does not represent that it manufactures its products with materials sold under any of these brand names. Customers sometimes ask for BETE products without using a USA standard specification for the material they require. When materials are described incompletely, with DIN specifications or with a commonly used brand name, BETE will usually supply materials according to the USA specifications listed above. Specifications for forms other than cast or bar may differ from the above.

The following are registered trademarks: Teflon®, Viton® (E.I. DuPont de Nemours & Co.); Hastelloy® (Haynes International, Inc.); Incoloy®, Monel® (The International Nickel Company, Inc.); Inconel® (Inco Nickel Sales, Inc.); Kynar® (Penwalt Corporation); REFRAX® (Carborundum Company); and Stellite® (Stoody Deloro Stellite, Inc.); M&M (Mars, Inc.) The BETE logo and MaxiPass are registered trademarks of BETE Fog Nozzle, Inc. ©BETE Fog Nozzle, Inc.

Since 1950 BETE has put nozzles into deep sea, deep space, and everywhere in between.

BETE's mission goes far beyond just selling nozzles: it is to provide spraying solutions that meet or exceed customer expectations in every detail. Extensive in-house capabilities—from CAD design through pattern testing—make it possible to offer the highest level of quality control throughout every phase



of production while providing the most responsive customer service in the industry. BETE nozzles provide life-saving fire protection on offshore oil rigs, clean compact disk masters between platings, cool off the hogs down on the farm, reduce SO₂ emissions at coal-fired generating stations, and even spray relish into huge mixing vats at food processing plants. Virtually every business uses nozzles—in equipment,

Nozzles may be a rather small component of major systems. But they are absolutely critical to performance and efficiency.

manufacturing or fire protection.

Their spray droplets can neutralize micron size pollutants, extinguish fires, cool hot gases, coat delicate electronic components, and much more.

BETE is a pioneer in all areas of nozzle manufacturing. The company was formed to produce John Bete's unique spiral (corkscrew) nozzle which can deliver a fine, high velocity spray at the lowest possible pressure.

Later, BETE developed the industry's leading clog-resistant design: the MaxiPass® full cone whirl nozzle, which boasts the maximum free passage possible.

More recently, BETE developed the SpiralAir® series of air atomizing nozzles which use compressed air or steam to convert large volumes of liquid into a finely atomized fog.

In each case, these

innovations have provided solutions to performance problems encountered with traditional nozzle designs. In fact, if there's one hallmark to The BETE Difference it's the ability to respond quickly and effectively to any kind of spraying challenge—whether simple or complex—anywhere in the world. BETE Applications Engineers will put their years of experience to work helping to determine the best way to provide the spray coverage and performance you need.



John Bete started the company in 1950 in a basement machine shop.

Innovative BETE nozzles have made the company a worldwide leader in the pollution control industry.

The first shower in space was taken by a U.S. astronaut using a special BETE nozzle.

The Spiral TFXP and MaxiPass are the industry's two leading clog-resistant designs.

BETE is the only nozzle manufacturer with a complete in-house investment casting foundry.

It takes eight minutes to heat 60 lbs. of stainless steel to the 2900°F required for casting.

BETE pioneered the use of many nozzle materials including PTFE and titanium.

Platinum is the most expensive material the company has ever used; every scrap was saved.

Traditional New England craftsmanship in a state-of-the-art manufacturing facility.

Computer terminals throughout the plant keep track of the status of your order.

Virtually any material that can be machined, cast or molded can be used to make a nozzle. The selection depends on the fluid being sprayed and operating conditions such as temperature, abrasiveness, and corrosiveness.

BETE has always taken advantage of the latest developments in materials technology to create the most efficient nozzles possible. In the late 1960s, the company began experimenting with nozzles made from the ceramic Silicon Nitride Bonded Silicon Carbide (SNBSC) because of its excellent corrosion and abrasion resistance. Later, BETE made the first nozzle out of the even stronger Reaction Bonded Silicon Carbide (RBSC); making the



production of ceramic spiral nozzles practical.

In the 1970s BETE pioneered the use of Cobalt Alloy 6, a cobalt-based alloy with excellent corrosion and abrasion resistance, and has led the way in the use of engineering plastics, particularly PTFE, in nozzle manufacture.

In 1977 BETE made a significant new production

commitment by setting up an in-house casting foundry. This established total control of quality and scheduling for orders requiring cast alloys such as Stainless Steel, Cobalt Alloy 6, and Nickel Alloy.

In the late '80s and early '90s BETE became one of the first foundries in the world to cast Nickel Alloy C-22®, a new chromium nickel-based alloy.

When evaluating various materials, it's important to consider the impact of nozzle life on plant efficiency.



BETE can perform every procedure in-house – from casting to machining to assembly.



BETE can help you select the material for maximum effectiveness and operating life in your application.

BETE uses three basic manufacturing processes: injection molding, machining from bar stock, and investment casting. Injection molding is used for large quantities of nozzles made from plastics such as PVC, ABS and PVDF. Bar stock machining is often used for metal alloy and plastic

nozzles which have relatively simple shapes or are made in small quantities. Investment casting offers a precise and economical way to produce complex shapes in alloys that are difficult or expensive to machine.

In addition, BETE offers many specialized processes. The welding department, which is fully qualified to ASME B & PV Code Section IX, has made a specialty of joining

dissimilar metals. This makes it possible to design nozzles combining alloys having superior anti-abrasion or corrosion properties with those having excellent machinability or weldability. Other specialized processes include plasma spray coating, plating, heat treating, grinding, ceramic fabrication, and filament winding of FRP.



BETE also does contract testing of nozzles and spray systems for many customers.

Complete in-house design and manufacturing mean on-time delivery.

A small change in a droplet's size, shape, or speed can have a major impact on performance.

Computer terminals throughout the plant keep track of the status of your order.

BETE's advanced CIM (Computer Integrated Manufacturing) environment links CAD workstations, a CAM part programming system and CNC machine tools.

The computerized scheduling system sequences every step in the production process, constantly adjusting the loads at each workstation to maximize throughput. This makes it possible to manufacture any one of thousands of products within a short time, while providing reliable delivery forecasts.



Spray Engineering

BETE's extensive resources and more than 60 years of experience are available to help you with nozzle selection, solving existing spray problems, or designing a new nozzle or process. The spray engineering group is available on a contract basis and works with all of BETE's resources to help you design your process or solve your spray problem. At each stage of contracted Advanced Spray Engineering Services (ASES) we work with you to ensure we're solving the right problem within the given constraints. Our resources include:

Physical Spray Laboratory Testing

For an engineering analysis we use our spray laboratory to evaluate the spray characteristics of a nozzle or process or to generate data for use in another analysis such as a CFD model. Spray characteristics like droplet size, spray angle, spray reach, and more can all be evaluated in the lab. In addition, we can evaluate hydrostatic integrity, reliability, and other essential nozzle characteristics not directly related to the spray. Noteworthy instrumentation includes:

- Patternator for measuring spray pattern
- BETE Model 700 Imaging Particle Analyzer
- TSI Phase-Doppler Particle Analyzer
- Integrated Data Acquisition Control System
- Containment Booth for alternative fluids
- Mechanical Inspection precision equipment

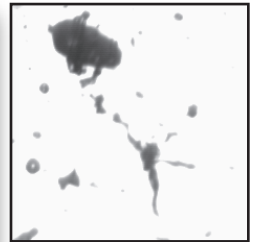

The BETE Droplet Analyzer is capable of characterizing non-spherical droplets like those seen in this actual image.

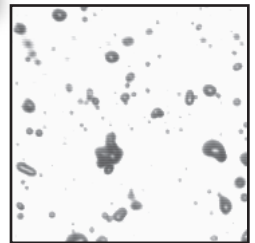

Actual droplet images captured using the BETE Model 700 Spray Analysis System.

Physical Models

Sometimes there is no substitute for actually testing a nozzle in a process. It could be that the physics is too complicated to model or the desired result, such as an aesthetic effect, may be difficult to measure, or it might be necessary to validate a computer model. In these cases we can build a model of the system and test it in the laboratory.

Computer Modeling

BETE offers computer modeling of sprays and processes using ANSYS® FLUENT® computational fluid dynamics software (CFD).

Modeling of a spray process can be very helpful in selecting nozzles, operating conditions, and mounting locations when initially designing a process especially if the process is not amenable to physical testing. It can also help find the cause of problems in an existing operation.

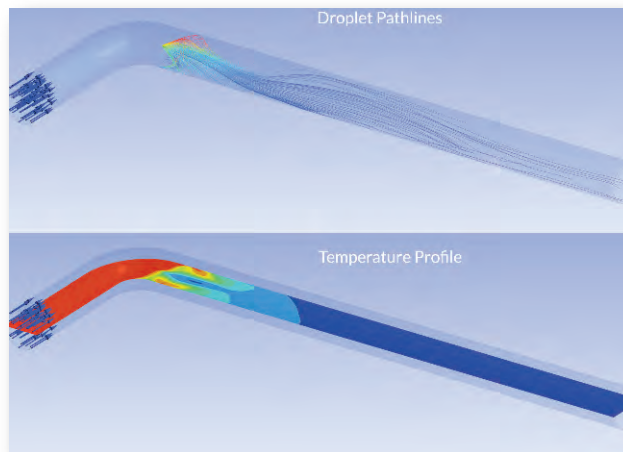

Are you ready to see how BETE's Advanced Spray Engineering can help? Tell us what you need by contacting Daniel deLesdernier: ddel@bete.com. We'll get back to you with an outline of what we can do for you.

While as a matter of course we maintain confidentiality, we are always willing to negotiate special confidentiality agreements if necessary.

Manufacturing

The manufacturing facility is only few steps away from the lab so when a goal of the engineering work is a piece of hardware we collaborate with our manufacturing and design groups throughout the analysis process to ensure that the result is manufacturable and cost-effective. The manufacturing group also is available to help build test nozzles and fixtures from nozzles with microscopic orifices to multi-ton fabrications.

Design of Experiments

When the number of variables in an experiment is large, careful selection of combinations of test conditions can reduce the amount of testing needed. BETE works with JMP statistical analysis software to assist with experimental design and data analysis.

Spray Systems

Leveraging decades of experience with advanced engineering and manufacturing resources, BETE has grown far beyond just spray nozzles and today we offer a one-stop shop for complete spray system solutions.

Visit www.bete.com/spray-systems for a video demo and more information.

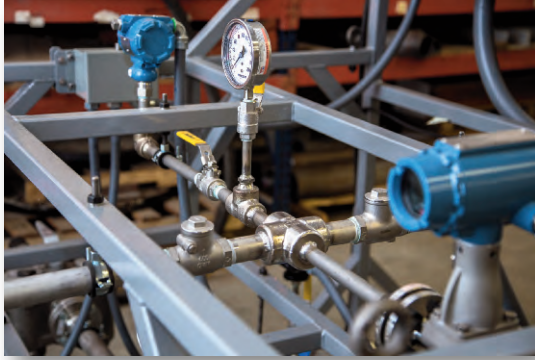

Exhaust Gas Cooling System



Aluminum Plate Quench System



The Whole Package

When it comes to providing high quality spray performance for your process, selection of an appropriate spray nozzle model is only the first step in successful implementation. Just as critical as spray nozzle selection is the engineering of upstream flow control equipment, such as pump and flow control skids, to ensure that nozzles are supplied with the proper fluid conditions to function as intended.

BETE's deep understanding of spray nozzle and fluid system performance allows us to design and build custom-tailored flow control systems that meet the specific needs of your spray process. Alternatively, if you have an existing spray system that does not perform as desired, we can evaluate your system and recommend changes to improve the performance and reliability of your spray process. Using a variety of engineering resources, we evaluate pressure losses caused by pipe friction, elevation, and valve or instrument flow coefficients. We then adjust pump and nozzle performance curves accordingly to make sure that your system will operate exactly the way you need it to.

For spray processes that require automation, our engineers have experience with a variety of controls options that can make spray parameter adjustments based on real-time process signals and feedback loops. These spray systems can operate as stand-alone units or further integrate with central plant control systems for remote monitoring and control input.

Our engineered systems may include any or all of the following components:

- Nozzles/lances
- Piping/tubing/fittings
- Valves
- Pressure regulators
- Strainers/filters
- Solenoids
- Pumps/motors
- Automatic control valves
- Pressure/temperature/flow sensors
- Variable Frequency Drives (VFDs)
- Programmable Logic Controllers (PLC)
- Switches, relays, and other electrical hardware
- Structural skid frames

Complete Spray System Solutions

From process engineering and nozzle selection assistance all the way to implementation of automated spray systems, contact us today to see how we can help you increase the performance, reliability, efficiency, and profitability of your spray process.

Spray Lances

INJECTORS QUILLS SPOOLS FABRICATIONS



BETE takes its ability to provide robust spray nozzles one step further to construct spray assembly fabrications that you can install for immediate use.

Refineries and chemical plants have counted on BETE for decades to supply complete fabricated assemblies, custom designed from the nozzle up. Starting with the process conditions, we recommend the most appropriate nozzle and then incorporate it into an assembly that meets all mechanical design criteria.

Custom Ring Header



BETE works to your requirements, from the most simple to the most complex. Incorporation of client specifications is routine for us as is design, fabrication, and inspection to Code requirements. All design and fabrication work is performed at the same facility, ensuring close coordination through all phases of the process to ensure all mechanical and performance requirements are met.

Design Requirements

- ASME B31.3 and B31.1 NBEP
- Welding qualification to ASME B&PVC, Section IX
- Canadian Registration (CRN)
- NACE compliance

Mechanical Inspections

- RT – Radiographic
- UT – Ultrasonic
- PT – Visible Dye Penetrant
- Hydrostatic
- Hardness
- PMI – Positive Material Identification

Performance Inspections

- Flow
- Spray Angle
- Droplet Size
- Special Customer Requirements

LANCES

Drop-in solutions

Whether you call them lances, quills, or injectors, BETE is your source.

Why endure the time and hassle to source pipe, flanges, nozzles, and fittings separately and then coordinate fabrication and testing of the assembly when you can have BETE do it all for you in an ISO 9001-controlled shop environment.

Fabrications are BETE's specialty, from complex Code compliant fabrications to simple pipe and flange assemblies. By using BETE as a single source supplier, you can concentrate on your larger process details, knowing that our experience is working for you.

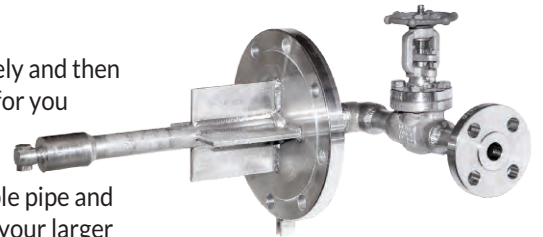

WTZ Lance with Inlet Valve and Gussets



Visit www.spraylances.com for more information

www.BETE.com

TO ORDER: specify pipe size, connection type, nozzle number, spray angle, and material.

RETRACTABLE LANCES

Maintenance without downtime

Retractable lances allow you to remove a nozzle for inspection or service without taking your process offline. A retractable lance allows you to withdraw your nozzle, isolate it from the process, and then remove it completely for servicing all while maintaining the integrity of the process boundary. Once the nozzle is serviced or inspected, simply reattach it to the system, open the isolation valve, and insert it back into the process.

For smaller pipe sizes, retractable lances can be inserted and withdrawn manually. For larger sizes, or any size where automation or ease of use is required, BETE offers a robust retraction mechanism that effortlessly moves the lance. A simple cordless drill is all that is required to power the unit, making this design a favorite with maintenance crews. The mechanism is flexible in its configuration, allowing alternate electric, pneumatic, or hydraulic power sources to drive the unit.

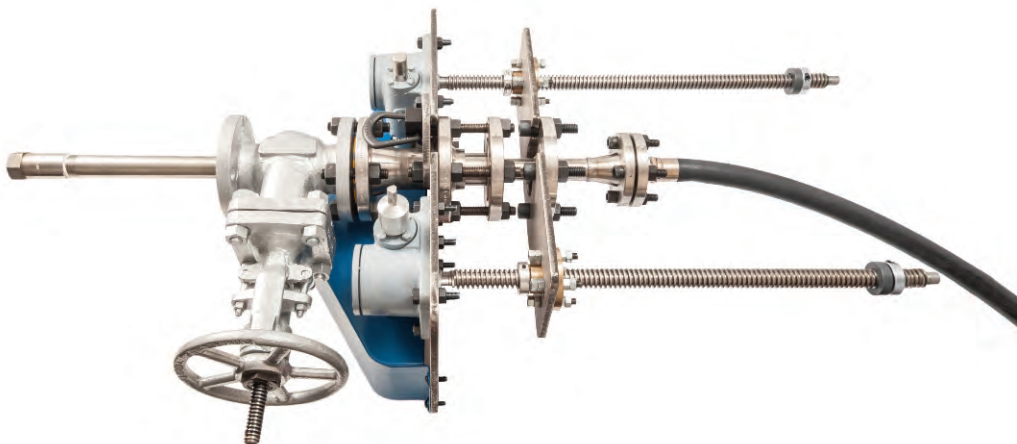
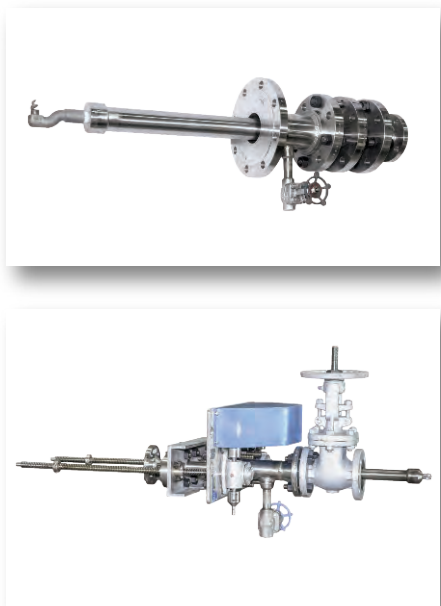

Complete retractable system including lance, isolation valve, and retraction mechanism

SPOOL SECTIONS

Complete spray solutions

Just as BETE can provide the lance on which the spray nozzle is installed, BETE can also provide the piping section into which the lance is installed. There are many benefits to single-sourcing all components related to the spray nozzle.

When all the work is done by one facility, there are no miscommunications between contractors about size, orientation, or location of the spray ports. The nozzles can be trial fit into the spool piece as part of the manufacturing process before leaving the factory. This translates to no last minute on-site surprises.

BETE provides everything you need from the concept design stage to on-site delivery, right down to the gaskets, studs, and nuts.

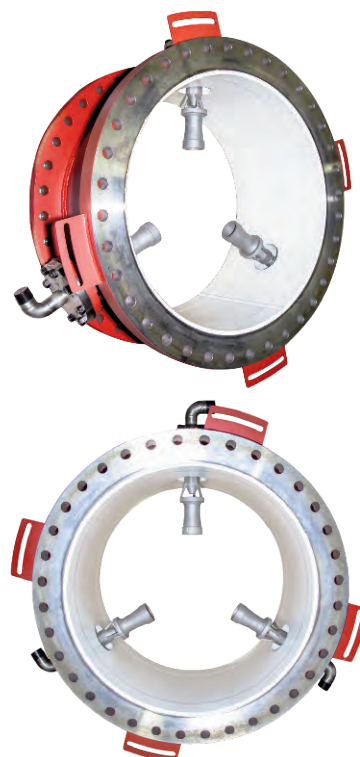



TF

Wide Range of Flows and Angles

DESIGN FEATURES

- The original spiral nozzle invented by BETE and continuously improved!
- High energy efficiency
- One-piece/no internal parts
- Clog-resistant performance
- High discharge velocity
- Male connection standard; female connection available by special order

SPRAY CHARACTERISTICS

- Wide range of flow rates and spray angles
 - Fine atomization
- Spray patterns:** Full Cone.
For Hollow Cone, see page 45
Spray angles: 50° to 180°
Flow rates: 0.5 to 3320 gpm
 (Higher flow rates available)

Available with FM approval: N series (page 102), 1/4" TF8 NN, FCN in brass, 1/2" TF24-150 in multiple materials

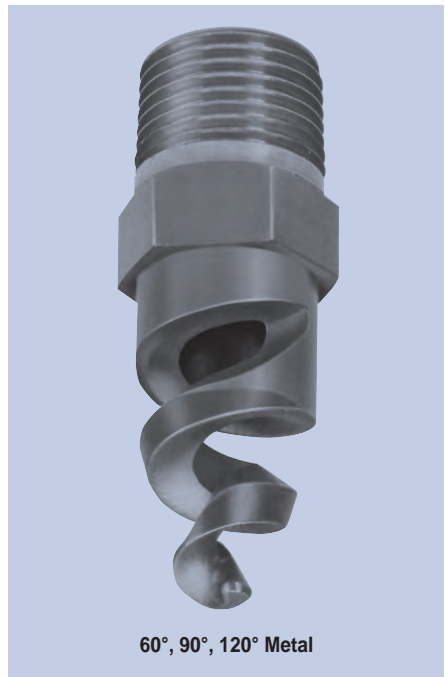

60°, 90°, 120° Metal



Full Cone 60° (NN)



Full Cone 90° (FCN)



Full Cone 150°/170°

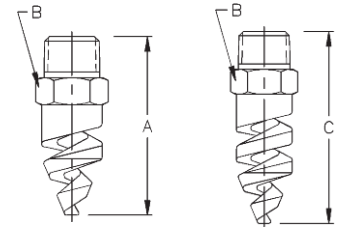

90°, 120°

150°, 170°

Dimensions are approximate. Check with BETE for critical dimension applications.

TF Full Cone Flow Rates and Dimensions

Full Cone, 60° (NN), 90° (FCN or FFCN), 120° (FC or FFC), 150°, and 170° Spray Angles, 1/8" to 4" Pipe Sizes

Male Pipe Size	Nozzle Number	Available Spray Angles 60° 90° 120° 150° 170°	K Factor	GALLONS PER MINUTE @ PSI											PTFE not recommended at pressures above red line				Approx. (in.)		Dim. (in.) for Metal Only*			Wt. (oz.)	
				5 PSI	10 PSI	20 PSI	30 PSI	40 PSI	50 PSI	60 PSI	80 PSI	100 PSI	200 PSI	400 PSI	Free Orif. Dia.	Pass. Dia.	A**	B	C	60° 120° Metal Plas.					
1/8	TF6	60° 90° 120° 150° 170°	0.221	0.495	0.70	0.99	1.21	1.40	1.57	1.71	1.98	2.21	3.13	4.43	0.09	0.09	1.69	0.56	1.69	1.00	0.20				
	TF8	60° 90° 120° 150° 170°	0.411	0.919	1.30	1.84	2.25	2.60	2.91	3.18	3.68	4.11	5.81	8.22	0.13	0.13	1.69	0.56	2.19						
1/4	TF6	60° 90° 120° 150° 170°	0.221	0.495	0.70	0.99	1.21	1.40	1.57	1.71	1.98	2.21	3.13	4.43	0.09	0.09	1.88	0.56	1.88	1.25	0.20				
	TF8	60° 90° 120° 150° 170°	0.411	0.919	1.30	1.84	2.25	2.60	2.91	3.18	3.68	4.11	5.81	8.22	0.13	0.13	1.88	0.56	2.38						
	TF10	60° 90° 120° 150° 170°	0.632	1.41	2.00	2.83	3.46	4.00	4.47	4.90	5.66	6.32	8.94	12.6	0.16	0.13	1.88	0.56	2.38						
3/8	TF6	60° 90° 120°	0.221	0.495	0.70	0.99	1.21	1.40	1.57	1.71	1.98	2.21	3.13	4.43	0.09	0.09									
	TF8	60° 90° 120°	0.411	0.919	1.30	1.84	2.25	2.60	2.91	3.18	3.68	4.11	5.81	8.22	0.13	0.13									
	TF10	60° 90° 120°	0.632	1.41	2.00	2.83	3.46	4.00	4.47	4.90	5.66	6.32	8.94	12.6	0.16	0.13									
	TF12	60° 90° 120° 150° 170°	0.949	2.12	3.00	4.24	5.20	6.00	6.71	7.35	8.49	9.49	13.4	19.0	0.19	0.13	1.88	0.69	2.38	1.63	0.25				
	TF14	60° 90° 120° 150° 170°	1.28	2.86	4.05	5.73	7.01	8.10	9.06	9.92	11.5	12.8	18.1	25.6	0.22	0.13									
1/2	TF24	60° 90° 120° 150° 170°	3.81	8.52	12.1	17.0	20.9	24.1	26.9	29.5	34.1	38.1	53.9	76.2	0.38	0.19	2.50	0.88	3.06	3.00	0.50				
	TF28	60° 90° 120° 150° 170°	5.22	11.7	16.5	23.3	28.6	33.0	36.9	40.4	46.7	52.2	73.8	104	0.44	0.19									
	TF32	60° 90° 120° 150° 170°	6.64	14.8	21.0	29.7	36.4	42.0	47.0	51.4	59.4	66.4	93.9	133	0.50	0.19	2.75	1.13	3.50	5.50	0.88				
1	TF40	60° 90° 120° 150° 170°	10.6	23.7	33.5	47.4	58.0	67.0	74.9	82.1	94.8	106	150	212	0.63	0.25	3.63	1.38	4.38	8.50	2.50				
	TF48	60° 90° 120° 150° 170°	15.0	33.6	47.5	67.2	82.3	95.0	106	116	134	150	212	300	0.75	0.25									
1 1/2	TF56	60° 90° 120° 150° 170°	20.4	45.6	64.5	91.2	112	129	144	158	182	204	288	408	0.88	0.31				5.38					
	TF64	60° 90° 120° 150° 170°	26.7	59.7	84.5	120	146	169	189	207	239	267	378	534	1.00	0.31	4.38	2.00	5.38	22.0	4.25				
	TF72	60° 90° 120° 150° 170°	30.4	67.9	96.0	136	166	192	215	235	272	304	429	607	1.13	0.31				5.63					
2	TF88	60° 90° 120° 150° 170°	44.3	99.0	140	198	242	280	313	343	396	443	626	885	1.38	0.44	5.63	2.50	5.88	46.0	8.00				
	TF96 ¹	60° 90° 120° 150° 170°	55.9	125	177	250	306	354	395	433	500	559	791	1120	1.50	0.44	6.88	2.50	7.00	54.0	9.00				
3	TF112	60° 90° 120° 150° 170°	81.0	181	256	362	443	512	572	627	724	810	1150	1620	1.75	0.56	8.63	3.50	9.25	114	20.0				
	TF128 ¹	60° 90° 120° 150° 170°	107	239	339	480	588	679	759	831	960	1070	1510	2150	2.00	0.56									
4	TF160 ¹	60° 90° 120°	166	371	525	742	909	1050	1170	1290	1480	1660	2350	3320	2.50	0.63	10.1	4.50		169	27.0				

Flow Rate (GPM) = $K \sqrt{PSI}$ *Dimensions are for bar stock, cast sizes may vary. **60° nozzles slightly longer, consult BETE. ¹ Three turn nozzles

Standard Materials: Brass, 316 Stainless Steel, PVC, Polypropylene, and PTFE (Poly. not available for TF6 thru TF10).

Spray angle performance varies with pressure. Contact BETE for specific data on critical applications.

TO ORDER: specify pipe size, connection type, nozzle number, spray angle, and material.

TFXP

Largest Free Passage

DESIGN FEATURES

- Largest free passage in the original spiral nozzle invented by BETE and continuously improved!
- Passes particles equal to orifice size
- Clog-resistant
- One-piece, extra heavy construction
- High energy efficiency
- Male connection

SPRAY CHARACTERISTICS

- Wide range of flow rates
 - Fine atomization
- Spray pattern:** Full Cone
(Hollow Cone available by special order)
- Spray angles:** 90° and 120°
- Flow rates:** 3.0 to 3320 gpm

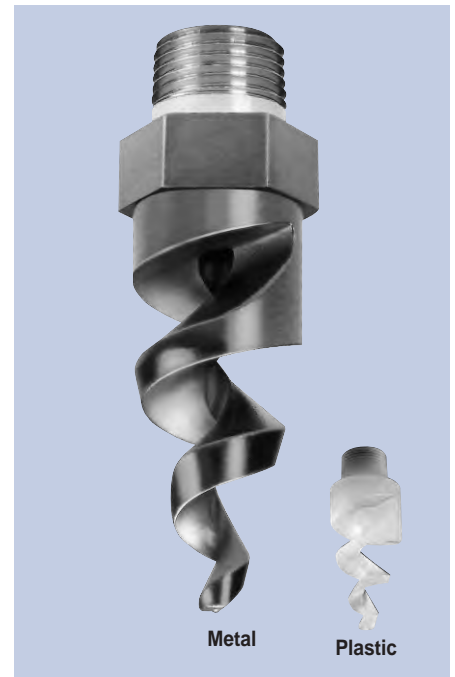

FULL CONE



Full Cone 90° (XPN)

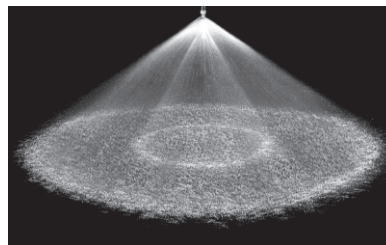

Full Cone 120° (XP)

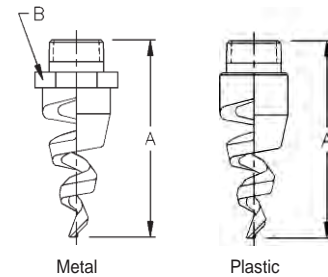

Dimensions are approximate. Check with BETE for critical dimension applications.

TFXP Flow Rates and Dimensions

Full Cone, 90° (XPN) and 120° (XP) Spray Angles, 3/8" to 4" Pipe Sizes

Male Pipe Size	Nozzle Number	K Factor	GALLONS PER MINUTE @ PSI						PTFE not recommended at pressures above red line Metal ONLY at pressures above green line				Approx. Free Pass. & Orifice Dia. (in.)	Approximate Dimensions (in.) for Metal Only		Wt. (lbs.)	
			10 PSI	20 PSI	30 PSI	40 PSI	50 PSI	60 PSI	80 PSI	100 PSI	200 PSI	400 PSI		A	B	Metal	Plas.
3/8	TF12	0.949	3.00	4.24	5.20	6.00	6.71	7.35	8.49	9.49	13.4	19.0	0.19	2.88	0.88	0.20	0.04
	TF14	1.28	4.05	5.73	7.01	8.10	9.06	9.92	11.5	12.8	18.1	25.6	0.22	2.88	0.88		
	TF16	1.68	5.30	7.50	9.2	10.6	11.9	13.0	15.0	16.8	23.7	33.5	0.25	2.75	0.88		
	TF20	2.61	8.25	11.7	14.3	16.5	18.4	20.2	23.3	26.1	36.9	52.2	0.31	3.12	0.88		
1/2	TF24	3.81	12.1	17.0	20.9	24.1	26.9	29.5	34.1	38.1	53.9	76.2	0.38	3.47	1.13	0.41	0.06
	TF28	5.22	16.5	23.3	28.6	33.0	36.9	40.4	46.7	52.2	73.8	104	0.44	3.50	1.13		
3/4	TF32	6.64	21.0	29.7	36.4	42.0	47.0	51.4	59.4	66.4	93.9	133	0.50	5.38	1.75	1.56	0.22
1	TF40	10.6	33.5	47.4	58.0	67.0	74.9	82.1	94.8	106	150	212	0.63	5.25	2.00	1.56	0.25
	TF48	15.0	47.5	67.2	82.3	95.0	106	116	134	150	212	300	0.75	6.63	2.00	2.06	0.47
1 1/2	TF56	20.4	64.5	91.2	112	129	144	158	182	204	288	408	0.88	6.97	2.50	4.00	0.59
	TF64	26.7	84.5	120	146	169	189	207	239	267	378	534	1.00	6.94	2.50	2.44	0.53
	TF72	30.4	96.0	136	166	192	215	235	272	304	429	607	1.13	7.41	2.50	2.81	0.53
2	TF88	44.3	140	198	242	280	313	343	396	443	626	885	1.38	10.5	2.63	5.12	1.25
	TF96	55.9	177	250	306	354	395	433	500	559	791	1120	1.50	11.0	2.63	6.31	1.25
3	TF112	81.0	256	362	443	512	572	627	724	810	1150	1620	1.75**	12.0	3.50	8.37	1.37
	TF128	107	339	480	588	679	759	829	960	1070	1510	2150	2.00**	11.7	3.50	9.75	1.50
4	TF160	166	525	742	909	1050	1170	1290	1480	1660	2350	3320	2.50**	12.0	4.50	15.6	1.87

Flow Rate (GPM) = $K \sqrt{PSI}$ **Free passage is 1.5"

Standard Materials: Brass, 316 Stainless Steel, PVC, Polypropylene, Cobalt Alloy 6, and PTFE.

Spray angle performance varies with pressure. Contact BETE for specific data on critical applications.



ST

Abrasion Resistant

DESIGN FEATURES

- Cobalt Alloy 6 or RBSC ceramic parts in high-wear areas
- High energy efficiency
- No internal parts
- Clog-resistant
- Male and female connections
- Flanged and special connections available as required

SPRAY CHARACTERISTICS

- Fine atomization
- Spray pattern:** Full Cone (Hollow Cone available by special order)
- Spray angles:** 90° and 120° standard
- Flow rates:** 0.5 to 3320 gpm (Higher flow rates available)

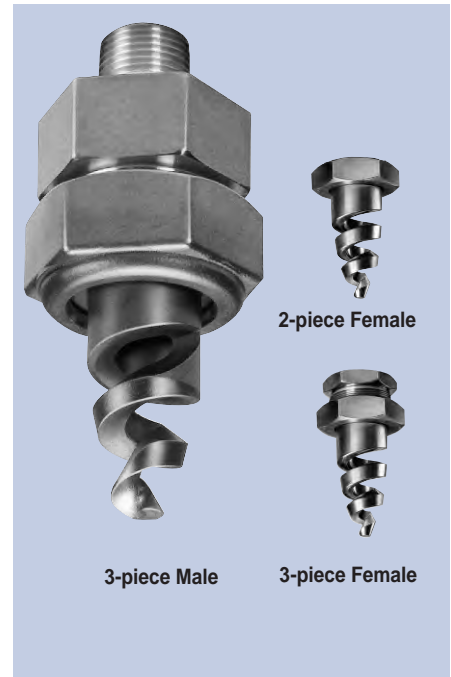

Full Cone 90° (FCN)



Full Cone 120° (FFC)

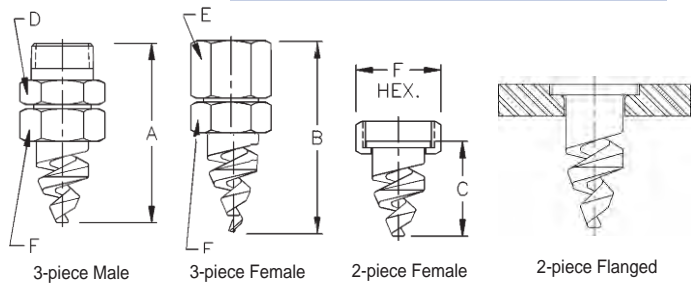

Dimensions are approximate. Check with BETE for critical dimension applications.

ST Flow Rates and Dimensions

Full Cone, 90° (FCN or FFCN) and 120° (FC or FFC) Spray Angles, 1/4" to 4" Pipe Sizes

3-piece Male or Female Pipe Size	** 2-piece Female Pipe Size	Nozzle Number	K Factor	GALLONS PER MINUTE @ PSI												Approx. (in) Free Orifice Pass.		Approximate Dimensions (in.)						Wt. (lbs.) Male
				5 PSI	10 PSI	15 PSI	20 PSI	30 PSI	40 PSI	50 PSI	60 PSI	80 PSI	100 PSI	200 PSI	400 PSI	Di.	Di.	A	B	C	D	E	F	
1/4		ST6	0.221	0.495	0.700	0.857	0.990	1.21	1.40	1.57	1.71	1.98	2.21	3.13	4.43	0.09	0.09	2.56	2.56	0.69	0.69	0.81	0.19	
		ST8	0.411	0.919	1.30	1.59	1.84	2.25	2.60	2.91	3.18	3.68	4.11	5.81	8.22	0.13	0.13	2.56	2.56	0.69	0.69	0.81		
		ST10	0.632	1.41	2.00	2.45	2.83	3.46	4.00	4.47	4.90	5.66	6.32	8.94	12.6	0.16	0.13	2.56	2.56	0.69	0.69	0.81		
3/8		ST12	0.949	2.12	3.00	3.67	4.24	5.20	6.00	6.71	7.35	8.49	9.49	13.4	19.0	0.19	0.13	2.94	2.94	0.94	0.94	1.13	0.31	
		ST14	1.28	2.86	4.05	4.96	5.73	7.01	8.10	9.06	9.92	11.5	12.8	18.1	25.6	0.22	0.13	2.88	2.88	0.94	0.94	1.13		
		ST16	1.68	3.75	5.30	6.49	7.50	9.18	10.6	11.9	13.0	15.0	16.8	23.7	33.5	0.25	0.13	3.00	3.00	0.94	0.94	1.13		
		ST20	2.61	5.83	8.25	10.1	11.7	14.3	16.5	18.4	20.2	23.3	26.1	36.9	52.2	0.31	0.13	2.88	2.88	0.94	0.94	1.13		
3/4		ST24	3.81	8.52	12.1	14.8	17.0	20.9	24.1	26.9	29.5	34.1	38.1	53.9	76.2	0.38	0.19	3.56	3.56	1.38	1.38	1.50	0.62	
		ST28	5.22	11.7	16.5	20.2	23.3	28.6	33.0	36.9	40.4	46.7	52.2	73.8	104	0.44	0.19	3.53	3.53	1.38	1.38	1.50		
		ST32	6.64	14.8	21.0	25.7	29.7	36.4	42.0	47.0	51.4	59.4	66.4	93.9	133	0.50	0.19	3.50	3.50	1.38	1.38	1.50		
1		ST40	10.6	23.7	33.5	41.0	47.4	58.0	67.0	74.9	82.1	94.8	106	150	212	0.63	0.25	4.50	4.50	1.88	1.75	2.00	1.25	
		ST48	15.0	33.6	47.5	58.2	67.2	82.3	95.0	106	116	134	150	212	300	0.75	0.25	4.50	4.50	1.88	1.75	2.00		
1 1/2		ST56	20.4	45.6	64.5	79.0	91.2	112	129	144	158	182	204	288	408	0.88	0.31	5.75	5.75	1.94	2.13	2.19	1.75	
		ST64	26.7	59.8	84.5	103	120	146	169	189	207	239	267	378	534	1.00	0.31	5.75	5.75	1.94	2.13	2.19		
		ST72	30.4	67.9	96.0	118	136	166	192	215	235	272	304	429	607	1.12	0.31	5.75	5.75	1.94	2.13	2.19		
2	2 1/2 3	ST88	44.3	99.0	140	171	198	242	280	313	343	396	443	626	885	1.37	0.44	7.63	6.31	4.56	3.00	3.50	3.50	5.00
		ST96 ¹	55.9	125	177	216	250	306	354	395	433	500	559	791	1120	1.50	0.44	9.00	7.38	5.63	3.63	4.00	4.00	7.00
3	3	ST112 ¹	81.0	181	256	314	362	443	512	572	627	724	810	1150	1620	1.75	0.56	10.3	8.84	6.84	3.63	4.00	4.00	9.00
		ST128 ¹	107	239	339	414	480	588	679	759	831	960	1070	1510	2150	2.00	0.56	10.7	9.28	7.28	3.63	4.00	4.00	
4	4	ST160 ¹	166	371	525	643	742	909	1050	1170	1290	1480	1660	2350	3320	2.50	0.63	11.9	10.25	8.25	4.56	5.00	5.00	14.0

Flow Rate (GPM) = $K \sqrt{PSI}$ ¹Three turn nozzles ****Parallel threads only**

Standard Materials: Base and Caps - 316 Stainless Steel; Tip - Cobalt Alloy 6 or RBSC Ceramic. (RBSC not available on nozzle numbers ST6 - ST32).

Spray angle performance varies with pressure. Contact BETE for specific data on critical applications.

STXP

Largest Free Passage

DESIGN FEATURES

- Abrasion resistant
- Cobalt Alloy 6 or RBSC ceramic parts in high-wear areas
- High energy efficiency
- Largest free passage in spiral design
- Extra heavy, rugged construction
- Male and female connections
- Flanged and special connections available as required

SPRAY CHARACTERISTICS

- Fine atomization
- Spray pattern:** Full Cone
(Hollow Cone available by special order)
- Spray angles:** 90° and 120° standard
- Flow rates:** 2.12 to 3320 gpm
(Higher flow rates available)

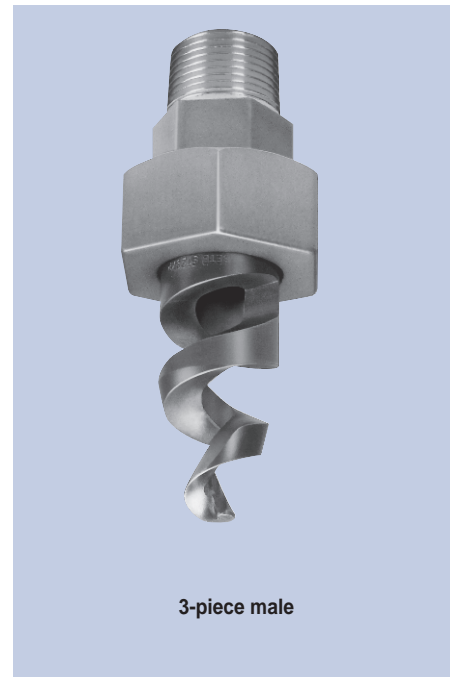

3-piece male



Full Cone 90° (XPN)

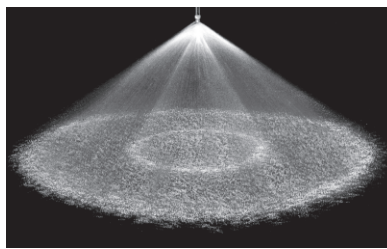

Full Cone 120° (XP)

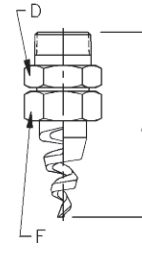

3-piece Male

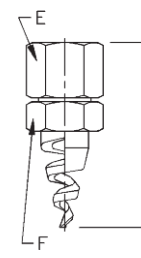

3-piece Female

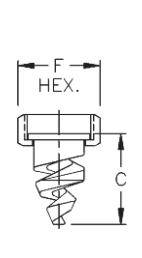

2-piece Female

Dimensions are approximate. Check with BETE for critical dimension applications.

STXP Flow Rates & Dimensions

Full Cone, 90° (XPN) and 120° (XP) Spray Angles, 3/8" to 4" Pipe Sizes

3-piece Male or Female Pipe Size	** Female Pipe Size	Nozzle Number	K Factor	GALLONS PER MINUTE @ PSI												Approx. (in.) Orifice & Free Pass. Dia.	Approximate Dimensions (in.)						Wt. (lbs.) Metal	
				5 PSI	10 PSI	15 PSI	20 PSI	30 PSI	40 PSI	50 PSI	60 PSI	80 PSI	100 PSI	200 PSI	400 PSI		A	B	C	D	E	F	Male	Fem.
3/8		ST12	0.949	2.12	3.00	3.67	4.24	5.20	6.00	6.71	7.35	8.49	9.49	13.4	19.0	0.19	3.94	3.38	2.13	1.38	1.38	1.50	0.5	0.5
		ST14	1.28	2.86	4.05	4.96	5.73	7.01	8.10	9.06	9.92	11.5	12.8	18.1	25.6	0.22	3.94	3.38	2.11	1.38	1.38	1.50		
		ST16	1.68	3.75	5.30	6.49	7.50	9.18	10.6	11.9	13.0	15.0	16.8	23.7	33.5	0.25	3.94	3.38	2.12	1.38	1.38	1.50		
		ST20	2.61	5.83	8.25	10.1	11.7	14.3	16.5	18.4	20.2	23.3	26.1	36.9	52.2	0.31	3.94	3.38	2.12	1.38	1.38	1.50		
3/4		ST24	3.81	8.52	12.1	14.8	17.0	20.9	24.1	26.9	29.5	34.1	38.1	53.9	76.2	0.38	4.56	3.81	2.68	1.19	1.19	1.75	1.1	1.1
		ST28	5.22	11.7	16.5	20.2	23.3	28.6	33.0	36.9	40.4	46.7	52.2	73.8	104	0.44	4.56	3.81	2.68	1.19	1.19	1.75	1.1	1.1
		ST32	6.64	14.8	21.0	25.7	29.7	36.4	42.0	47.0	51.4	59.4	66.4	93.9	133	0.50	5.14	5.12	4.22	1.50	1.50	2.19	2.0	2.0
1		ST40	10.6	23.7	33.5	41.0	47.4	58.0	67.0	74.9	82.1	94.8	106	150	212	0.63	6.31	5.30	4.05	1.88	1.88	2.75	3.0	2.6
		ST48	15.0	33.6	47.5	58.2	67.2	82.3	95.0	106	116	134	150	212	300	0.75	7.44	6.44	5.56	1.88	1.88	2.75		
1 1/2	2 1/2	ST56	20.4	45.6	64.5	79.0	91.2	112	129	144	158	182	204	288	408	0.88	8.56	7.25	5.50	3.00	3.00	3.50	6.0	3.4
		ST64	26.7	59.8	84.5	103	120	146	169	189	207	239	267	378	534	1.00	8.56	7.25	5.71	3.00	3.00	3.50		
		ST72	30.4	67.9	96.0	118	136	166	192	215	235	272	304	429	607	1.13	8.88	7.63	5.73	3.00	3.00	3.50		
2	3	ST88	44.3	99.0	140	171	198	242	280	313	343	396	443	626	885	1.38	11.8	8.00	8.38	3.63	3.63	4.00	8.0	4.0
		ST96	55.9	125	177	216	250	306	354	395	433	500	560	791	1120	1.50	11.4	10.2	8.60	3.63	3.63	4.00		
3	3	ST112	81.0	181	256	314	362	443	512	572	627	724	810	1150	1620	1.75 ¹	11.9	11.8	8.56	3.63	4.00	4.00	10	5.9
		ST128	107	239	339	414	480	588	679	759	829	960	1070	1510	2150	2.00 ¹	12.6	11.8	8.56	3.63	4.00	4.00		
4	4	ST160	166	371	525	643	742	909	1050	1170	1290	1480	1660	2350	3320	2.50 ¹	13.0	13.0	10.0	5.00	5.00	5.00	12	10

Flow Rate (GPM) = $K\sqrt{PSI}$ ¹Free Passage is 1.5" ^{**}Parallel threads only

Standard Materials: Base and Caps - 316 Stainless Steel; Tip - Cobalt Alloy 6 or RBSC Ceramic. (RBSC not available on nozzle numbers STXP12 - STXP32).

Spray angle performance varies with pressure. Contact BETE for specific data on critical applications.



WL

Low Flow/Full Cone

DESIGN FEATURES

- Advanced whirl plate design produces uniform coverage
- Male and female connections

SPRAY CHARACTERISTICS

- Medium to coarse atomization
- Spray pattern:** Full Cone. Square patterns available for most sizes.
- Spray angles:** 30°, 60°, 90° and 120° standard
- Flow rates:** 0.13 to 59 gpm



Metal

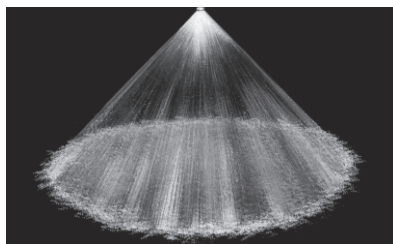

Full Cone 90°



Full Cone 120°

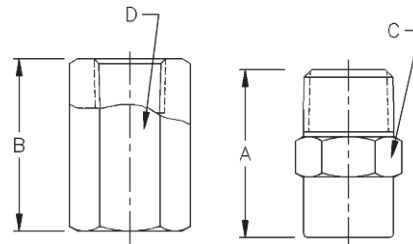

Female Metal

Male Metal

Dimensions are approximate. Check with BETE for critical dimension applications.

WL Flow Rates and Dimensions

Full Cone, 30°, 60°, 90° and 120° Spray Angles

Male or Female Pipe Size	Nozzle Number	K Factor	GALLONS PER MINUTE @ PSI										Approx. Orifice Dia. (in.)	Dimensions for Metal Only (in.)				Wt. (oz.)		
			10 PSI	20 PSI	30 PSI	40 PSI	60 PSI	80 PSI	100 PSI	150 PSI	200 PSI	400 PSI		A	B	C	D	Metal	Plas.	
1/8*	WL 1/4**	0.044	0.13	0.18	0.22	0.25	0.30	0.35	0.38	0.47	0.53	0.74	0.043							
	WL 1/2	0.088	0.26	0.36	0.44	0.50	0.60	0.69	0.77	0.93	1.07	1.48	0.055	0.88	1.13	0.44	0.56	1.00	0.25	
	WL 3/4	0.132	0.39	0.54	0.66	0.75	0.91	1.04	1.15	1.40	1.60	2.21	0.072							
1/4	WL 1	0.177	0.52	0.72	0.87	1.00	1.21	1.39	1.54	1.86	2.13	2.95	0.082	1.06	1.38	0.56	0.69	1.50	0.38	
	WL 1 1/2	0.265	0.78	1.08	1.31	1.50	1.81	2.08	2.31	2.79	3.20	4.43	0.109							
3/8	WL 2	0.353	1.04	1.44	1.75	2.00	2.42	2.77	3.08	3.72	4.26	5.90	0.125							
	WL 3	0.530	1.56	2.17	2.62	3.00	3.63	4.16	4.61	5.58	6.39	8.85	0.156	1.25	1.50	0.69	0.88	2.00	0.50	
	WL 4	0.706	2.08	2.89	3.49	4.00	4.84	5.54	6.15	7.44	8.52	11.8	0.188							
1/2	WL 5	0.883	2.61	3.61	4.37	5.00	6.05	6.93	7.69	9.31	10.6	14.8	0.203							
	WL 6	1.06	3.13	4.33	5.24	6.00	7.26	8.31	9.23	11.2	12.8	17.7	0.219	1.50	2.00	0.88	1.13	3.00	1.00	
	WL 7	1.24	3.65	5.05	6.11	7.00	8.47	9.70	10.8	13.0	14.9	20.7	0.228							
3/4	WL 8	1.41	4.17	5.78	6.99	8.00	9.68	11.1	12.3	14.9	17.0	23.6	0.234							
	WL 10	1.77	5.21	7.22	8.74	10.0	12.1	13.8	15.4	18.6	21.3	29.5	0.281	1.75	2.13	1.13	1.38	6.00	1.50	
	WL 12	2.12	6.25	8.66	10.5	12.0	14.5	16.6	18.5	22.3	25.6	35.4	0.312							
1	WL 15	2.65	7.82	10.8	13.1	15.0	18.1	20.8	23.1	27.9	32.0	44.3	0.328	2.19	2.38	1.38	1.63	14.0	3.50	
	WL 20	3.53	10.4	14.4	17.5	20.0	24.2	27.7	30.8	37.2	42.6	59.0	0.375							

$$\text{Flow Rate (GPM)} = K (\text{PSI})^{0.47}$$

Standard Materials: Brass, 303 Stainless Steel, 316 Stainless Steel, PVC, Polypropylene, and PTFE

*1/8" PTFE and Polypropylene not available in 120°.

**1/8 WL-1/4 not available in Polypropylene.

Spray angle performance varies with pressure. Contact BETE for specific data on critical applications.

TO ORDER: specify pipe size, connection type, nozzle number, spray angle, and material.

MaxiPass® L

Low Flow, Full Cone, Maximum Free Passage

DESIGN FEATURES

- 1/8 and 1/4 pipe connection sizes
- Ultimate clog-resistant design, with the **largest free passage available** in an axial, full-cone nozzle
- Unique, S-shaped internal vanes allow free passage of particles
- High-energy efficiency
- Easily handles dirty, contaminated liquids
- Male connections
- Nozzle body available in Brass, 303, 316 Stainless Steel
- Vanes are 316 Stainless Steel for optimum wear and corrosion resistance

SPRAY CHARACTERISTICS

- High reliability spray performance under the most difficult conditions
 - Uniform spray distribution
- Spray pattern:** Full Cone
Spray angles: Narrow (N), Medium (M), Wide (W)
Flow rates: 0.12 to 2.03 gpm

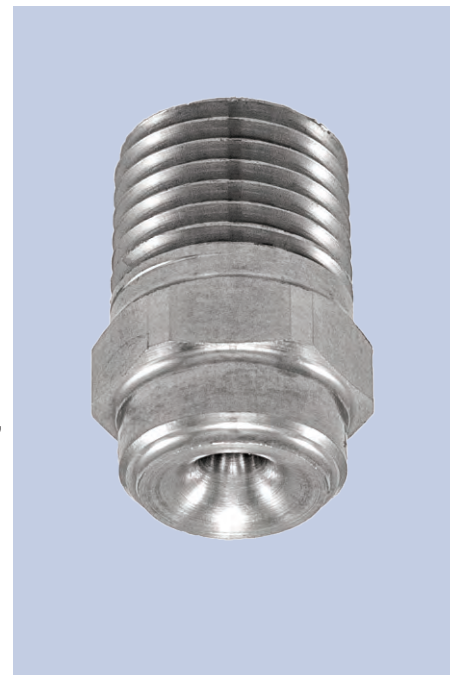
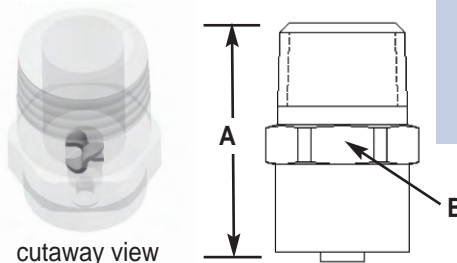

FULL CONE

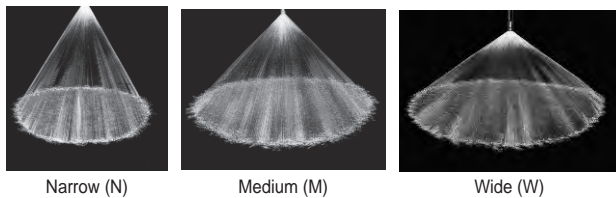

MaxiPass L Ordering Nomenclature			
pipe connection size	1/8	MPL0.21M	-B - 316
	series	flow rating	material
			BSP thread connection
			spray angle

MaxiPass L (MPL) Flow Rates

Male Pipe Size	K Factor	Nozzle Number	GALLONS PER MINUTE @ PSI							
			10 PSI	20 PSI	30 PSI	40 PSI	50 PSI	60 PSI	70 PSI	80 PSI
1/8	0.043	MPL0.21	0.12	0.16	0.19	0.21	0.23	0.25	0.27	0.28
	0.061	MPL0.30	0.17	0.22	0.27	0.30	0.33	0.36	0.38	0.40
	0.086	MPL0.42	0.23	0.31	0.37	0.42	0.46	0.50	0.53	0.57
	0.117	MPL0.57	0.31	0.42	0.51	0.57	0.63	0.68	0.73	0.77
1/4	0.158	MPL0.77	0.42	0.57	0.68	0.77	0.85	0.92	0.98	1.04
	0.229	MPL1.12	0.62	0.83	0.99	1.12	1.23	1.33	1.42	1.51
	0.309	MPL1.51	0.83	1.12	1.33	1.51	1.66	1.80	1.92	2.03

Flow Rate (GPM) = K (PSI)^{0.43}

Spray Angle and Dimensions

Nozzle Number	N spray angle	M spray angle	W spray angle	Approx. Free Passage Dia. (in.)			Approx. Dimensions (in.)		Wt. (oz) Metal
	40 PSI	40 PSI	40 PSI	N	M	W	A length	B hex size	
MPL0.21	51	77	129	0.037	0.036	0.036	0.70	7/16	0.30
MPL0.30	53	86	134	0.043	0.039	0.044			
MPL0.42	51	90	128	0.053	0.047	0.044			
MPL0.57	61	92	127	0.06	0.057	0.052			
MPL0.77	62	90	125	0.067	0.067	0.067	0.88	9/16	0.62
MPL1.12	60	92	124	0.085	0.081	0.081			
MPL1.51	70	97	123	0.105	0.09	0.09			

Spray angle performance varies with pressure. Contact BETE Applications Engineering for specific data on critical applications.

Dimensions are approximate. Check with BETE for critical dimension applications.



MaxiPass®

Maximum Free Passage

DESIGN FEATURES

- Ultimate clog-resistant design with largest free passage available in a full cone nozzle
- Two unique S-shaped internal vanes allow free passage of particles
- High energy efficiency
- Easily handles dirty, lumpy liquids
- Male and female connections
- Flanged connection available
- U.S. Patent

SPRAY CHARACTERISTICS

- High reliability spray performance under the most difficult conditions
- Spray pattern:** Full Cone
(Square patterns to special order)
- Spray angles:** 30°, 60°, 90°, and 120°
- Flow rates:** 0.7 to 978 gpm
(Flow rates up to 4500 gpm available; call BETE Applications Engineering for details.)



Wide Angle Metal

FULL CONE

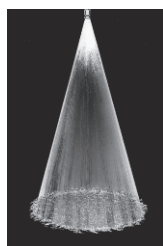

Full Cone 30° (NN)

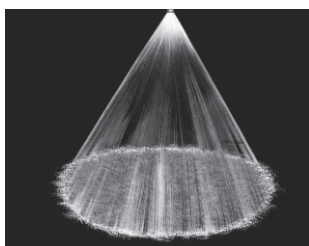

Full Cone 60° (N)

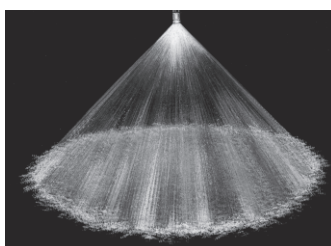

Full Cone 90° (M)



Full Cone 120° (W)

Dimensions are approximate. Check with BETE for critical dimension applications.

MaxiPass Flow Rates and Dimensions

Full Cone, Extra Narrow 30° (NN), Narrow 60° (N), Medium 90° (M) and Wide 120° (W) Spray Angles, 3/8" to 4" Pipe Sizes

Male or Female Pipe Size	Nozzle Number	K Factor	GALLONS PER MINUTE @ PSI											Approx. Free Passage Dia. (in.)	Approx. Dimensions (in.) Overall length (MAX)					Wt.** (lbs.) Metal
			3 PSI	5 PSI	7 PSI	10 PSI	15 PSI	20 PSI	30 PSI	40 PSI	60 PSI	80 PSI	30°		60°	90°	120°	A	B	
3/8*	MP125	0.416	0.70	0.89	1.04	1.23	1.49	1.70	2.06	2.35	2.85	3.26	0.125	-	1.50	1.50	1.50	0.88	0.19	
	MP156	0.661	1.11	1.41	1.65	1.95	2.36	2.70	3.27	3.74	4.52	5.18	0.156	-	1.50	1.50	1.50	0.88	0.19	
	MP187	0.954	1.60	2.03	2.38	2.82	3.41	3.90	4.72	5.40	6.54	7.48	0.188	-	1.50	1.50	1.50	0.88	0.16	
1/2*	MP187	0.954	1.60	2.03	2.38	2.82	3.41	3.90	4.72	5.40	6.54	7.48	0.188	-	1.88	1.88	1.88	1.00	0.28	
	MP218	1.52	2.54	3.23	3.79	4.48	5.42	6.20	7.50	8.59	10.4	11.9	0.219	-	1.88	1.88	1.88	1.00	0.25	
	MP250	1.71	2.87	3.65	4.27	5.05	6.11	7.00	8.47	9.70	11.7	13.4	0.250	-	1.88	1.88	1.88	1.00	0.25	
3/4	MP281	2.10	3.53	4.48	5.25	6.21	7.51	8.60	10.4	11.9	14.4	16.5	0.281	4.00	2.50	2.50	2.50	1.25	0.50	
	MP312	2.54	4.26	5.42	6.35	7.51	9.08	10.4	12.6	14.4	17.4	20.0	0.312	4.00	2.50	2.50	2.50	1.25	0.50	
	MP343	3.11	5.21	6.62	7.75	9.17	11.1	12.7	15.4	17.6	21.3	24.4	0.344	4.00	2.50	2.50	2.50	1.25	0.44	
	MP375	3.67	6.15	7.82	9.16	10.8	13.1	15.0	18.1	20.8	25.1	28.8	0.375	4.00	2.50	2.50	2.50	1.25	0.44	
1	MP375	3.67	6.15	7.82	9.16	10.8	13.1	15.0	18.1	20.8	25.1	28.8	0.375	4.38	2.94	2.94	2.94	1.50	0.78	
	MP406	4.40	7.38	9.38	11.0	13.0	15.7	18.0	21.8	24.9	30.2	34.5	0.406	4.38	2.94	2.94	2.94	1.50	0.72	
	MP437	5.14	8.61	10.9	12.8	15.2	18.3	21.0	25.4	29.1	35.2	40.3	0.438	4.38	2.94	2.94	2.94	1.50	0.72	
1 1/4	MP437	5.14	8.61	10.9	12.8	15.2	18.3	21.0	25.4	29.1	35.2	40.3	0.438	5.38	3.38	3.38	3.38	2.00	1.34	
	MP500	6.61	11.1	14.1	16.5	19.5	23.6	27.0	32.7	37.4	45.2	51.8	0.500	5.38	3.38	3.38	3.38	2.00	1.34	
	MP531	7.34	12.3	15.6	18.3	21.7	26.2	30.0	36.3	41.6	50.3	57.6	0.531	5.38	3.38	3.38	3.38	2.00	1.34	
	MP562	8.07	13.5	17.2	20.1	23.8	28.8	33.0	39.9	45.7	55.3	63.3	0.562	5.38	3.38	3.38	3.38	2.00	1.34	
1 1/2	MP562	8.07	13.5	17.2	20.1	23.8	28.8	33.0	39.9	45.7	55.3	63.3	0.550	7.25	4.38	4.38	4.38	2.25	2.00	
	MP593	9.17	15.4	19.5	22.9	27.1	32.8	37.5	45.4	51.9	62.8	71.9	0.594	7.25	4.38	4.38	4.38	2.25	2.00	
	MP625	9.79	16.4	20.8	24.4	28.9	34.9	40.0	48.4	55.4	67.0	76.7	0.625	7.25	4.38	4.38	4.38	2.25	2.00	
	MP656	11.9	19.9	25.3	29.6	35.0	42.4	48.5	58.7	67.2	81.3	93.0	0.656	7.25	4.38	4.38	4.38	2.25	2.00	
	MP687	12.5	20.9	26.6	31.1	36.8	44.6	51.0	61.7	70.6	85.5	97.8	0.688	7.25	4.38	4.38	4.38	2.25	2.00	

Flow Rate (GPM) = K (PSI)^{0.47} ** Weights given are for 60°, 90°, and 120°

Standard Materials: Brass, 316 Stainless Steel, PVC, Polypropylene, and PTFE. (PTFE not available in 3/8" and 1/2" sizes. Cobalt A6 not available in 3/8".)

The spray angle of wide and medium angle whirl nozzles is affected by increasing pressure. *3/8" and 1/2" sizes: 30° not available, 60° not available in plastic Contact BETE Applications Engineering when using the MaxiPass above 40 PSI.

Spray angle and pattern vary with pressure. Contact BETE for specific data on critical applications.

TO ORDER: specify pipe size, connection type, nozzle number, spray angle, and material.



A cutaway view of the MaxiPass nozzle showing the S-shaped vanes that enable the nozzle to successfully handle large particles without clogging.



**MaxiPass®
Free Passage**

**Traditional Full Cone
Free Passage**

A comparison of the free passage available with the BETE MaxiPass nozzle compared to the free passage of a traditional full cone nozzle. The BETE MaxiPass is designed to pass solid particles that are 2-3 times larger in diameter than particles that will pass through a traditional full cone nozzle.

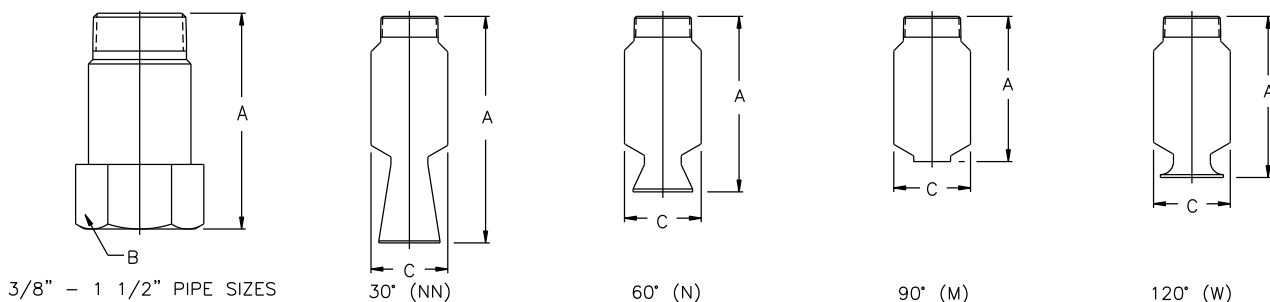

For plastic dimensions, please call BETE Customer Service.

Dimensions are approximate. Check with BETE for critical dimension applications.

MaxiPass Flow Rates and Dimensions

Full Cone, Extra Narrow 30°(NN), Narrow 60° (N), Medium 90°(M) and Wide 120°(W) Spray Angles, 3/8" to 4" Pipe Sizes

Male or Female Pipe Size	Nozzle Number	K Factor	GALLONS PER MINUTE @ PSI										Approx. Free Passage Dia. (in.)	Approx. Dimensions (in.) Overall Length (MAX)					Wt.** (lbs.) Metal
			3 PSI	5 PSI	7 PSI	10 PSI	15 PSI	20 PSI	30 PSI	40 PSI	60 PSI	80 PSI		30° A	60° A	90° A	120° A	C*	
2	MP750	15.2	25.4	32.3	37.9	44.8	54.2	62.0	75.0	85.9	104	119	0.750	8.25	7.19	6.30	6.30	2.69	3.50
	MP812	16.6	27.9	35.4	41.5	49.1	59.4	68.0	82.3	94.2	114	130	0.813						
	MP875	20.5	34.4	43.8	51.3	60.6	73.4	84.0	102	116	141	161	0.875						
	MP937	23.0	38.5	49.0	57.4	67.9	82.1	94.0	114	130	158	180	0.938						
	MP1000	26.9	45.1	57.3	67.2	79.4	96.1	110	133	152	184	211	1.00	10.3	7.63	6.00	6.75	3.25	3.75
MP1125	33.0	55.3	70.4	82.4	97.5	118	135	163	187	226	259	1.12							
2 1/2	MP1000	26.9	45.1	57.3	67.2	79.4	96.1	110	133	152	184	211	1.00	12.0	9.63	6.50	7.13	3.25	4.50
	MP1125	33.0	55.3	70.4	82.4	97.5	118	135	163	187	226	259	1.12						
	MP1250	39.6	66.4	84.4	98.9	117	142	162	196	224	271	311	1.24						
	MP1375	47.5	79.5	101	118	140	169	194	235	269	325	372	1.37						
3	MP1500	58.2	97.6	124	145	172	208	238	288	330	399	457	1.50	13.5	11.0	9.00	9.88	4.75	7.25
	MP1625	68.5	115	146	171	202	245	280	339	388	469	537	1.62						
	MP1750	78.3	131	167	195	231	280	320	387	443	536	614	1.75						
4	MP1750	78.3	131	167	195	231	280	320	387	443	536	614	1.75	16.0	10.7	8.88	9.81	4.78	8.00
	MP1875	88.1	148	188	220	260	314	360	436	499	603	691	1.87						
	MP2000	103	173	220	258	305	369	422	511	585	707	810	1.96						
	MP2125	115	193	245	287	339	411	470	569	651	788	902	2.12						
	MP2250	125	209	266	311	368	446	510	617	706	855	978	2.25	16.0	14.5	11.6	12.7	6.06	16.0

Flow Rate (GPM) = K (PSI)^{0.47}

* C dimension for 30° (NN) is larger

** Weights given are for 60°, 90°, and 120°

Standard Materials: Brass, 316 Stainless Steel, PVC, Polypropylene, and PTFE.

The spray angle of wide and medium angle whirl nozzles is affected by increasing pressure. Contact BETE Applications Engineering when using the MaxiPass above 40 PSI.

Spray angle and pattern vary with pressure. Contact BETE for specific data on critical applications.

CW

Low Flow

DESIGN FEATURES

- Standard 3-piece construction
- Optional 50- or 100-mesh strainer (refer to page 121 for additional information)
- Male and female connections
- Interchangeable spray tips

SPRAY CHARACTERISTICS

- **Spray patterns:** Full Cone (F).
- For Hollow Cone (H), see page 44.
- **Spray angles:** 80° and 120°
- **Flow rates:** 0.13 to 1.54 gpm



Male Metal



Full Cone 80° (F)



Hollow Cone 80° (H)

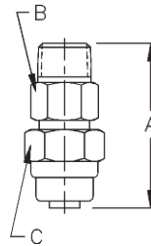

Male

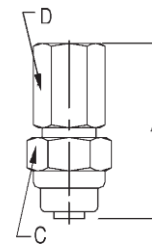

Female

Dimensions are approximate. Check with BETE for critical dimension applications.

CW Flow Rates and Dimensions

Full Cone, 80° and 120° Spray Angles, 1/8" to 3/8" Pipe Sizes

Male or Female Pipe Size	Nozzle Number	K Factor	GALLONS PER MINUTE @ PSI											Approx. Orifice Dia. (in.)	Male or Female Pipe Size	Dimensions (in.)				Wt. (oz.) Metal
			10 PSI	20 PSI	30 PSI	40 PSI	50 PSI	60 PSI	70 PSI	80 PSI	90 PSI	100 PSI	A			B	C	D		
1/8 or 1/4 or 3/8	CW25-F	0.044	0.13	0.18	0.22	0.25	0.28	0.30	0.33	0.35	0.37	0.38	0.045	1/8 - 1/4	2.06	0.68	0.81	0.68	2.5	
	CW50-F	0.088	0.26	0.36	0.44	0.50	0.56	0.60	0.65	0.69	0.73	0.77	0.054							
	CW75-F	0.132	0.39	0.54	0.66	0.75	0.83	0.91	0.98	1.04	1.10	1.15	0.063	3/8	2.06	0.68	0.81	0.81		
	CW100-F	0.177	0.52	0.72	0.87	1.00	1.11	1.21	1.30	1.39	1.46	1.54	0.086							

Flow Rate (GPM) = $K(PSI)^{0.47}$

Standard Materials: Brass, 303 Stainless Steel and 316 Stainless Steel.

Spray angle performance varies with pressure. Contact BETE for specific data on critical applications.

WTZ

Right Angle Full Cone

DESIGN FEATURES

- No internal parts, clog-resistant
- Uniform distribution
- Male and female connections
- Large free passage

SPRAY CHARACTERISTICS

Spray pattern: Full Cone
Spray angle: 90° and 110°
Flow rates: 0.18 to 49 gpm

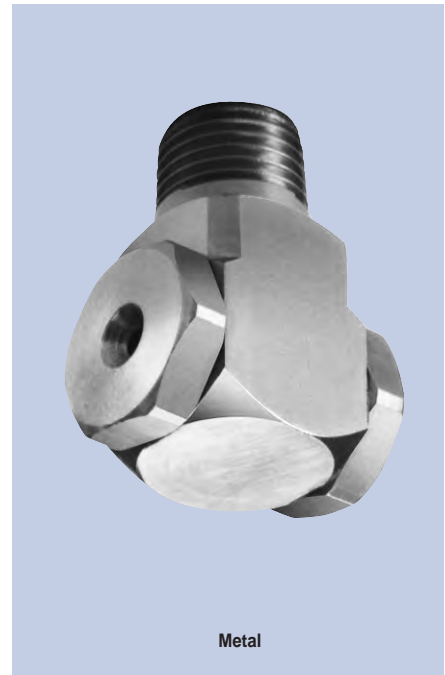

FULL CONE

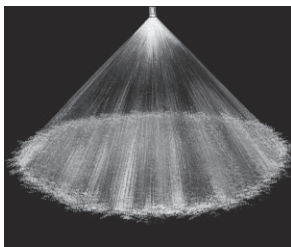

Full Cone 90°



Full Cone 110°

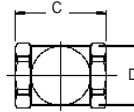
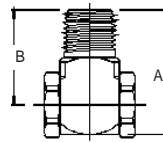

Metal

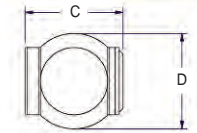
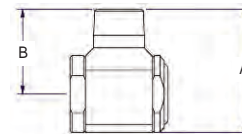

3/4" and 1"

Spray angle performance varies with pressure.

Contact BETE for specific data on critical applications.

Dimensions are approximate.
 Check with BETE for critical dimension applications.

WTZ Flow Rates and Dimensions

Full Cone, 90° and 110° Spray Angles, 1/4", 3/8", 1/2", 3/4", and 1" Pipe Size

Male or Female Pipe Size	Nozzle Number	K Factor	GALLONS PER MINUTE @ PSI									Approx. Orifice Dia. (in)	Dimensions (in.) Metal Only			
			5 PSI	10 PSI	15 PSI	20 PSI	30 PSI	40 PSI	60 PSI	80 PSI	100 PSI		A	B	C	D
1/4"	WTZ 50	0.079	0.18	0.25	0.30	0.35	0.43	0.50	0.61	0.70	0.79	0.075	1.31	1.00	0.80	0.63
	WTZ 56	0.088	0.20	0.28	0.34	0.39	0.48	0.56	0.68	0.79	0.88	0.079				
	WTZ 62	0.098	0.22	0.31	0.38	0.44	0.54	0.62	0.76	0.88	0.98	0.083				
	WTZ 77	0.122	0.27	0.39	0.47	0.55	0.67	0.77	0.95	1.10	1.22	0.091				
3/8"	WTZ 98	0.155	0.35	0.49	0.60	0.69	0.85	0.98	1.20	1.38	1.55	0.102	1.50	1.12	1.17	0.75
	WTZ 120	0.196	0.44	0.62	0.76	0.88	1.07	1.24	1.52	1.75	1.96	0.118				
	WTZ 150	0.245	0.55	0.77	0.95	1.10	1.34	1.55	1.90	2.19	2.45	0.130				
	WTZ 170	0.275	0.61	0.87	1.06	1.23	1.50	1.74	2.13	2.46	2.75	0.138				
	WTZ 200	0.309	0.69	0.98	1.20	1.38	1.69	1.95	2.39	2.76	3.09	0.146				
	WTZ 250	0.392	0.88	1.24	1.52	1.75	2.15	2.48	3.04	3.51	3.92	0.163				
	WTZ 280	0.441	0.99	1.39	1.71	1.97	2.42	2.79	3.42	3.95	4.41	0.173				
	WTZ 310	0.490	1.10	1.55	1.90	2.19	2.69	3.10	3.80	4.39	4.90	0.183				
WTZ 390	0.613	1.37	1.94	2.37	2.74	3.36	3.88	4.75	5.48	6.13	0.205					
WTZ 500	0.785	1.75	2.48	3.04	3.51	4.30	4.96	6.08	7.02	7.85	0.228					
1/2"	WTZ 620	0.98	2.19	3.10	3.80	4.38	5.37	6.20	7.59	8.77	9.80	0.287	1.87	1.38	1.48	1.00
	WTZ 780	1.23	2.74	3.88	4.75	5.48	6.71	7.75	9.49	11.0	12.3	0.315				
	WTZ 980	1.54	3.45	4.88	5.98	6.91	8.46	9.77	12.0	13.8	15.4	0.343				
	WTZ 1120**	1.77	3.96	5.60	6.86	7.92	9.70	11.2	13.7	15.8	17.7	0.389				
	WTZ 1280**	2.02	4.53	6.40	7.84	9.05	11.1	12.8	15.7	18.1	20.2	0.420				
WTZ 1440**	2.28	5.09	7.20	8.82	10.2	12.5	14.4	17.6	20.4	22.8	0.391					
3/4" *	WTZ 1200	1.90	4.24	6.00	7.35	8.49	10.4	12.0	14.7	17.0	19.0	0.335	3.00	2.00	2.00	2.00
	WTZ 1500	2.37	5.30	7.50	9.19	10.6	13.0	15.0	18.4	21.2	23.7	0.412				
	WTZ 1900	3.00	6.72	9.50	11.6	13.4	16.5	19.0	23.3	26.9	30.0	0.469				
1" *	WTZ 2200	3.48	7.78	11.0	13.5	15.6	19.1	22.0	26.9	31.1	34.8	0.500	3.20	2.20	2.55	2.48
	WTZ 3100	4.90	11.0	15.5	19.0	21.9	26.9	31.0	38.0	43.8	49.0	0.531				

Flow Rate (GPM) = K √PSI

Standard Materials: Brass, PVC, 303 Stainless Steel and 316 Stainless Steel.

*Male connection standard; female connection available by special order.

**90° Spray Angle ONLY; other angles available on request.

CALL 413-772-0846
 Call for the name of your nearest BETE representative.

EZ_{TF WL}

EZ Change Quick Connection System

DESIGN FEATURES

- Nozzles can be changed in seconds without tools
- Three part nozzle, base, gasket and interchangeable tip
- Exclusive ramped engagement for efficient, automatic alignment
- Threaded adapters will accommodate other standard BETE nozzles. Shut-off plugs are also available
- Sanitary EZs are available with weld connection and no knurling

SPRAY CHARACTERISTICS

- Available in six standard tips: EZTF; EZWL; EZWT; EZFF; EZNF; EZSPN

More EZ tips:

Hollow Cone: page 46
Flat Fan: pages 66 and 67

Flow rates: 0.04 to 58.4 gpm

Spray Angle:

EZTF: 60°, 90°, 120°, 150°, and 170°
EZWL: 30°, 60°, 90°, 120°



EZTF



120° Full Cone



90° Full Cone Spiral

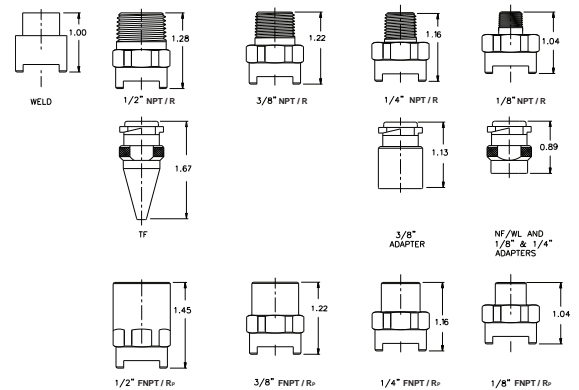

EZTF Flow Rates and Dimensions

Full Cone Spiral 60° (NN), 90° (FCN), 120° (FC), 150°, 170° Spray Angle 1/8" to 1/2" Pipe Sizes

Pipe Size	Nozzle Number	K Factor	GALLONS PER MINUTE @ PSI											Approx. Orifice Dia. (in.)	Approx. Assembly Dim. (in.)		Wt. (oz.)	
			5 PSI	10 PSI	20 PSI	30 PSI	40 PSI	60 PSI	80 PSI	100 PSI	200 PSI	400 PSI	500 PSI		Hex	Length		
1/8" TO 1/2"	EZTF6	0.221	0.49	0.70	0.99	1.21	1.40	1.71	1.98	2.21	3.13	4.43	4.94	0.09	1/8"	0.88	2.41	2.2
	EZTF8	0.411	0.92	1.30	1.84	2.25	2.60	3.18	3.68	4.11	5.81	8.22	9.19	0.13				
	EZTF10	0.632	1.41	2.00	2.83	3.46	4.00	4.90	5.66	6.32	8.94	12.6	14.1	0.16	1/4"	0.88	2.53	2.2
	EZTF12	0.949	2.12	3.00	4.24	5.20	6.00	7.35	8.49	9.49	13.4	19.0	21.2	0.19				
1/4" TO 1/2"	EZTF14	1.28	2.86	4.05	5.73	7.01	8.10	9.92	11.5	12.8	18.1	25.6	28.6	0.22	3/8"	0.88	2.59	2.6
	EZTF16	1.68	3.76	5.30	7.50	9.18	10.6	13.0	15.0	16.8	23.7	33.5	37.6	0.25				
	EZTF20	2.61	5.83	8.25	11.7	14.3	16.5	20.2	23.3	26.1	36.9	52.2	58.4	0.31	1/2"	0.88	2.65	2.6

Flow Rate (GPM) = $K \sqrt{\text{PSI}}$

TF14-TF20 not available with 1/8" base

Standard Materials: Brass, Viton gaskets standard. 316 Stainless Steel available upon request.

EZWL Flow Rates and Dimensions

Full Cone Whirl 30°, 60°, 90°, 120° Spray Angle; 1/8" to 1/2" Pipe Sizes

Pipe Size	Nozzle Number	K Factor	GALLONS PER MINUTE @ PSI											Approx. Orifice Dia. (in.)	Approx. Assembly Dim. (in.)		Wt. (oz.)	
			5 PSI	10 PSI	20 PSI	30 PSI	40 PSI	60 PSI	80 PSI	100 PSI	200 PSI	400 PSI	500 PSI		Hex	Length		
1/8" TO 1/2"	EZWL 1/4	0.044	0.09	0.13	0.18	0.22	0.25	0.30	0.35	0.38	0.53	0.74	0.82	0.043				
	EZWL 1/2	0.088	0.19	0.26	0.36	0.44	0.50	0.60	0.69	0.77	1.07	1.48	1.64	0.055	1/8"	0.88	1.63	2.2
	EZWL 3/4	0.132	0.28	0.39	0.54	0.66	0.75	0.91	1.04	1.15	1.60	2.21	2.46	0.072				
	EZWL1	0.177	0.38	0.52	0.72	0.87	1.00	1.21	1.39	1.54	2.13	2.95	3.28	0.082	1/4"	0.88	1.75	2.2
1/2"	EZWL 1 1/2	0.265	0.56	0.78	1.08	1.31	1.50	1.81	2.08	2.31	3.20	4.43	4.92	0.109				
	EZWL2	0.353	0.75	1.04	1.44	1.75	2.00	2.42	2.77	3.08	4.26	5.90	6.56	0.125	3/8"	0.88	1.81	2.6
	EZWL3	0.530	1.13	1.56	2.17	2.62	3.00	3.63	4.16	4.61	6.39	8.85	9.83	0.156				
	EZWL4	0.706	1.51	2.08	2.89	3.49	4.00	4.84	5.54	6.15	8.52	11.8	13.1	0.188	1/2"	0.88	1.87	2.9
	EZWL5	0.883	1.88	2.26	3.61	4.37	5.00	6.05	6.93	7.69	9.31	10.6	14.8	0.203				
	EZWL6	1.06	2.26	3.13	4.33	5.24	6.00	7.26	8.31	9.23	11.2	12.8	17.7	0.219				

Flow Rate (GPM) = $K (\text{PSI})^{0.47}$

Note: Square pattern also available

Standard Materials: 303 Stainless Steel, 316 Stainless Steel, Brass, Viton gaskets standard.

Dimensions are approximate. Check with BETE for critical dimension applications.

Spray angle performance varies with pressure. Contact BETE for specific data on critical applications.

TO ORDER: specify pipe size, connection type, nozzle number, spray angle, and material.

SF

Snap Release Nozzle System

DESIGN FEATURES

- Nozzles can be quickly changed and aligned by hand without tools
- Clamp-on adapter fits any style nozzle
- Quick set-up system features special "Snap-in" tips
- Polypropylene, resistant to most acids and alkalis
- Double clamp base or adapter available for higher pressure operation



80° Full Cone

SPRAY CHARACTERISTICS

- Quick Set-up System can be provided with fan, hollow or full cone spray tips
- Full 45° alignment of spray without tools

More SF Nozzle Systems:

Hollow Cone: page 48

Flat Fan: page 68

Flow rates: 0.35 to 15.8 gpm

Spray angles:

Full Cone: 35°, 65°, 80°

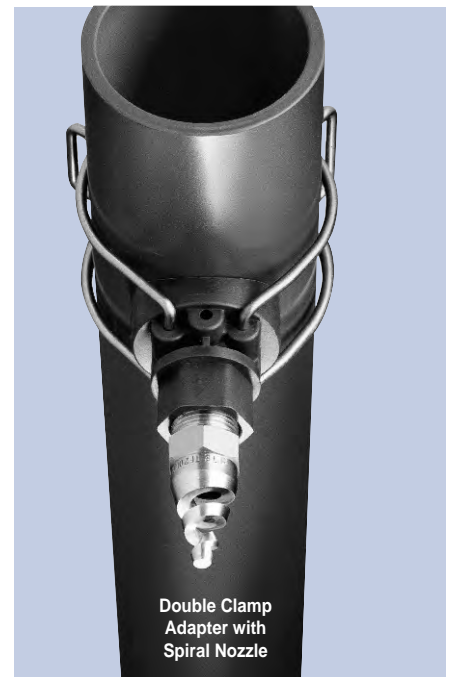
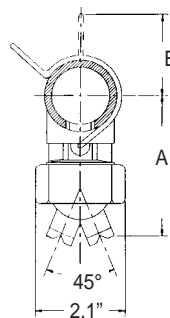

Double Clamp Adapter with Spiral Nozzle



FULL CONE

CLAMP-ON ADAPTER

- Available for 1", 1-1/4", 1-1/2" and 2" pipe.
- Available with 1/8", 1/4", 3/8", 1/2" NPT female threads; or 1/8" BSP female threads
- Available with single or double clamp.
- **TO ORDER ADAPTER Specify: Pipe Size, thread size, thread type, number of clamps, materials.**

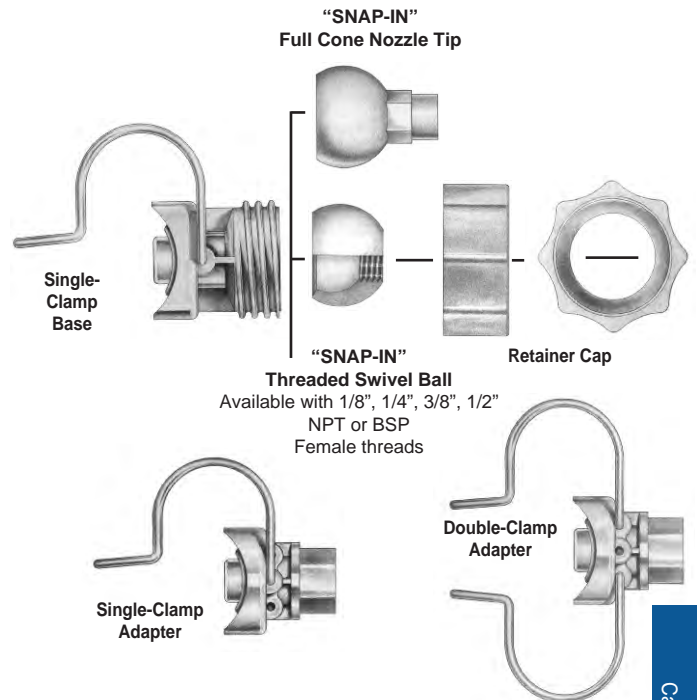

SF Flow Rates and Dimensions

SF Full Cone 35°, 65° and 80° Spray Angles 1", 1-1/4", 1-1/2" and 2" Pipe Sizes

Nozzle Number	Available Spray Angle	K Factor	GALLONS PER MINUTE @ PSI										Pipe Size	Body Color	Approx Dim. (in.)		Wt. (oz.)
			5 PSI	10 PSI	15 PSI	20 PSI	30 PSI	40 PSI	60 PSI	80 PSI	100 PSI	A			B		
SF31FC	35°	0.527	1.14	1.59	1.94	2.22	2.70	3.10	3.77	4.32	4.81	1"	blue	3.3	1.7	2.0	
SF32FC	80°	0.545	1.18	1.64	2.00	2.29	2.79	3.20	3.89	4.46	4.97	1-1/4"	red	3.4	1.9	2.2	
SF102FC	65°	1.736	3.76	5.24	6.37	7.31	8.88	10.2	12.4	14.2	15.8	1-1/2"	purple	3.6	2.0	2.2	
												2"	green	3.7	2.2	2.2	

$$\text{Flow Rate (GPM)} = K(\text{PSI})^{0.48}$$

Standard Materials: Polypropylene, 302 Stainless Steel clamp, EPDM seal.

Optional Materials: Viton seal.

NOTE: Drill 21/32" hole in pipe to install SF.

NOTE: Maximum recommended working pressures for SF assemblies: with single clamp, 70 psi for 1" pipe; 50 psi for 1-1/4" and 1-1/2" pipe; and 35 psi for 2" pipe; with double clamp up to 150 psi.

CALL 413-772-0846
Call for the name of your nearest BETE representative.



SC

Cast Metal Alloy

DESIGN FEATURES

- Complete line of full cone nozzles made in cast metal alloys
- Internal removable vane available
- Male and female connections
- Flanged connections available
- For plastic nozzles, see NC (pp. 34, 35), or MaxiPass (pp. 26, 27)

SPRAY CHARACTERISTICS

- **Spray pattern:** Full Cone with uniform distribution. For square spray patterns, please contact BETE.
- **Spray angles:** 60°, 90°, and 120°
- **Flow rates:** 1.68 to 2150 gpm



Male

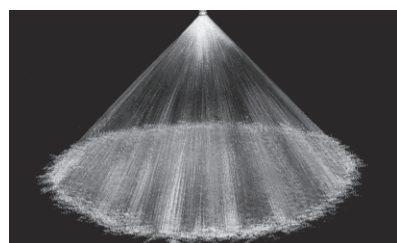

Full Cone 90° (M)

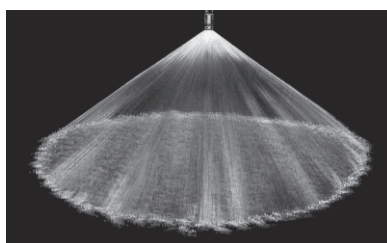

Full Cone 120° (W)

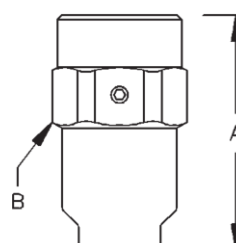

60° / 90° / 120° Female

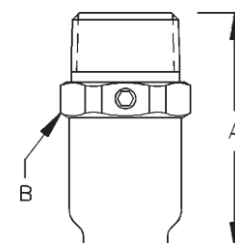

60° / 90° / 120° Male

Dimensions are approximate. Check with BETE for critical dimension applications.

SC Flow Rates & Dimensions

Full Cone, Narrow 60° (N), Medium 90° (M) and Wide 120° (W) Spray Angles, 3/4" to 6" Pipe Sizes

Male or Female Pipe Size	Nozzle Number	Available Spray Angles 60° 90° 120°	K Factor	GALLONS PER MINUTE @ PSI										Approx. Orifice Dia. (in.)	Approx. Free Pass. Dia. (in.)	Male Dim. (in.)		Wt. (lbs.) Metal
				3 PSI	5 PSI	7 PSI	10 PSI	20 PSI	40 PSI	60 PSI	80 PSI	100 PSI	A			B		
3/4	SC 2.5	60° 90°	1.00	1.68	2.13	2.50	2.96	4.09	5.67	6.86	7.86	8.72	0.19					
	SC 3	60° 90° 120°	1.20	2.01	2.56	3.00	3.55	4.91	6.81	8.23	9.43	10.5	0.20					
	SC 4	60° 90° 120°	1.60	2.69	3.41	4.00	4.73	6.55	9.07	11.0	12.6	14.0	0.28	0.19	2.00	1.22	0.3	
	SC 6	90° 120°	2.40	4.03	5.12	6.00	7.10	9.83	13.6	16.5	18.9	20.9	0.30					
	SC 7	90° 120°	2.81	4.70	5.98	7.00	8.28	11.5	15.9	19.2	22.0	24.4	0.35					
1	SC 4.2	60° 90°	1.68	2.82	3.59	4.20	4.97	6.88	9.53	11.5	13.2	14.7	0.25	0.25				
	SC 7	60° 90° 120°	2.80	4.70	5.98	7.00	8.28	11.5	15.9	19.2	22.0	24.4	0.33	0.31				
	SC 8	60° 90° 120°	3.21	5.37	6.83	8.00	9.46	13.1	18.1	22.0	25.1	27.9	0.35	0.31				
	SC 9	60° 90° 120°	3.61	6.04	7.68	9.00	10.6	14.7	20.4	24.7	28.3	31.4	0.40	0.31	2.88	1.50	0.7	
	SC 10	60° 90° 120°	4.01	6.72	8.54	10.0	11.8	16.4	22.7	27.4	31.4	34.9	0.42	0.31				
	SC 11	60° 90° 120°	4.41	7.39	9.39	11.0	13.0	18.0	25.0	30.2	34.6	38.4	0.44	0.31				
1 1/4	SC 12	90° 120°	4.81	8.06	10.2	12.0	14.2	19.7	27.2	32.9	37.7	41.9	0.46	0.31				
	SC 6	60° 90°	2.40	4.03	5.12	6.00	7.10	9.83	13.6	16.5	18.9	20.9	0.30	0.30				
	SC 10	60° 90° 120°	4.01	6.72	8.54	10.0	11.8	16.4	22.7	27.4	31.4	34.9	0.39	0.38				
	SC 12	60° 90° 120°	4.81	8.06	10.2	12.0	14.2	19.7	27.2	32.9	37.7	41.9	0.42	0.38				
	SC 14	60° 90° 120°	5.61	9.40	12.0	14.0	16.6	22.9	31.8	38.4	44.0	48.9	0.46	0.38	3.50	1.88	1.3	
	SC 16	60° 90° 120°	6.41	10.7	13.7	16.0	18.9	26.2	36.3	43.9	50.3	55.8	0.48	0.38				
	SC 17	60° 90° 120°	6.81	11.4	14.5	17.0	20.1	27.8	38.6	46.7	53.4	59.3	0.53	0.38				
SC 20	90° 120°	8.01	13.4	17.1	20.0	23.7	32.8	45.4	54.9	62.8	69.8	0.63	0.38					

Flow Rate (GPM) = K (PSI)^{0.47}

Standard Materials: Brass, Carbon Steel and 316 Stainless Steel.

Spray angle performance varies with pressure. Contact BETE for specific data on critical applications.

TO ORDER: specify pipe size, connection type, nozzle number, spray angle, and material.



FULL CONE

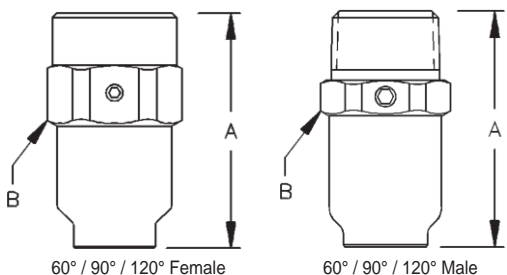

Dimensions are approximate. Check with BETE for critical dimension applications.

SC Flow Rates & Dimensions
Full Cone, Narrow 60° (N), Medium 90° (M) and Wide 120° (W) Spray Angles, 3/4" to 6" Pipe Sizes

Male or Female Pipe Size	Nozzle Number	Available Spray Angles			K Factor	GALLONS PER MINUTE @ PSI								Approx. Orifice Dia. (in.)	Approx. Free Pass. Dia. (in.)	Dim. (in.)		Wt. (lbs.) Metal	
		60°	90°	120°		3 PSI	5 PSI	7 PSI	10 PSI	20 PSI	40 PSI	60 PSI	80 PSI			100 PSI	A		B
1 1/2	SC 10	60°	90°		4.01	6.72	8.54	10.0	11.8	16.4	22.7	27.4	31.4	34.9	0.39	0.38	3.88	2.19	1.8
	SC 16	60°	90°	120°	6.41	10.7	13.7	16.0	18.9	26.2	36.3	43.9	50.3	55.8	0.53	0.38			
	SC 20	60°	90°	120°	8.01	13.4	17.1	20.0	23.7	32.8	45.4	54.9	62.8	69.8	0.56	0.41			
	SC 24	60°	90°	120°	9.62	16.1	20.5	24.0	28.4	39.3	54.4	65.9	75.4	83.8	0.63	0.41			
	SC 29	90°	120°		11.6	19.5	24.8	29.0	34.3	47.5	65.8	79.6	91.1	101	0.69	0.41			
	SC 30	90°	120°		12.0	20.1	25.6	30.0	35.5	49.1	68.1	82.3	94.3	105	0.75	0.41			
2	SC 17	60°	90°		6.81	11.4	14.5	17.0	20.1	27.8	38.6	46.7	53.4	59.3	0.48	0.48	5.12	2.75	3.3
	SC 30	60°	90°	120°	12.0	20.1	25.6	30.0	35.5	49.1	68.1	82.3	94.3	105	0.64	0.56			
	SC 35	60°	90°	120°	14.0	23.5	29.9	35.0	41.4	57.3	79.4	96.1	110	122	0.72	0.56			
	SC 40	60°	90°	120°	16.0	26.9	34.1	40.0	47.3	65.5	90.7	110	126	140	0.78	0.56			
	SC 47	60°	90°	120°	18.8	31.6	40.1	47.0	55.6	77.0	107	129	148	164	0.97	0.56			
	SC 50	60°	90°	120°	20.0	33.6	42.7	50.0	59.1	81.9	113	137	157	174	1.10	0.56			
	SC 60	90°	120°		24.0	40.3	51.2	60.0	71.0	98.3	136	165	189	209	1.14	0.75			
2 1/2	SC 25	60°	90°		10.0	16.8	21.3	25.0	29.6	40.9	56.7	68.6	78.6	87.2	0.61	0.61	6.28	3.25	6.5
	SC 50	60°	90°		20.0	33.6	42.7	50.0	59.1	81.9	113	137	157	174	0.87	0.75			
	SC 60	60°	90°	120°	24.0	40.3	51.2	60.0	71.0	98.3	136	165	189	209	0.96	0.75			
	SC 70	60°	90°	120°	28.1	47.0	59.8	70.0	82.8	115	159	192	220	244	1.07	0.75			
	SC 80	60°	90°	120°	32.1	53.7	68.3	80.0	94.6	131	181	220	251	279	1.15	0.75			
	SC 90	60°	90°	120°	36.1	60.4	76.8	90.0	106	147	204	247	283	314	1.27	0.75			
	SC 90	90°	120°		36.1	60.4	76.8	90.0	106	147	204	247	283	314	1.27	0.75			
3	SC 42	60°	90°		16.8	28.2	35.9	42.0	49.7	68.8	95.3	115	132	147	0.75	0.75	7.16	3.75	9.4
	SC 58	60°	90°		23.2	38.9	49.5	58.0	68.6	95.0	131.6	159	182	202	0.90	0.90			
	SC 80	60°	90°	120°	32.1	53.7	68.3	80.0	94.6	131	181	220	251	279	1.10	1.00			
	SC 90	60°	90°	120°	36.1	60.4	76.8	90.0	106	147	204	247	283	314	1.20	1.00			
	SC 95	60°	90°	120°	38.1	63.8	81.1	95.0	112	156	216	261	299	332	1.13	1.00			
	SC 100	60°	90°	120°	40.1	67.2	85.4	100	118	164	227	274	314	349	1.34	1.00			
	SC 117	60°	90°	120°	46.9	78.6	99.9	117	138	192	265	321	368	408	1.42	1.00			
	SC 120	60°	90°	120°	48.1	80.6	102	120	142	197	272	329	377	419	1.5	1.00			
	SC 135	90°	120°		54.1	90.7	115	135	160	221	306	371	424	471	1.64	1.00			
4	SC 125	60°	90°		50.1	83.9	107	125	148	205	284	343	393	436	1.35		8.64	4.75	15.8
	SC 130	60°	90°		52.1	87.3	111	130	154	213	295	357	409	454	1.38				
	SC 160	60°	90°		64.1	107	137	160	189	262	363	439	503	558	1.60				
	SC 180	60°	90°	120°	72.1	121	154	180	213	295	408	494	566	628	1.72	1.33			
	SC 188	60°	90°	120°	75.3	126	161	188	222	308	427	516	591	656	1.69				
	SC 200	60°	90°	120°	80.1	134	171	200	237	328	454	549	628	698	1.88				
	SC 210	60°	90°	120°	84.1	141	179	210	248	344	476	576	660	733	2.03				
	SC 250	90°	120°		100	168	213	250	296	409	567	686	786	872	2.25				
6	SC 350	60°	90°	120°	140	235	299	350	414	573	794	961	1100	1220	2.60	1.38	*	*	*
	SC 480	90°	120°		192	322	410	480	568	786	1090	1320	1510	1680	2.80	1.69	*	*	*
	SC 615	90°	120°		246	413	525	615	727	1010	1400	1690	1930	2150	3.00	1.69	*	*	*

Flow Rate (GPM) = K (PSI)^{0.47} * Dimensions vary with spray angle ordered, please call for dimensions

Standard Materials: Brass, Carbon Steel and 316 Stainless Steel.

Spray angle performance varies with pressure. Contact BETE for specific data on critical applications.

CALL 413-772-0846
 Call for the name of your nearest BETE representative.

NC

Threaded Connection/Plastic Material

DESIGN FEATURES

- Complete line of full cone nozzles made of plastic
- Male and female connections
- Flanged connection available in larger models—see NCFL (p. 38)
- For metal alloy nozzles, refer to MaxiPass (pp. 26, 27), SC (pp. 32, 33), or TC (p. 39) Series

SPRAY CHARACTERISTICS

Spray pattern: Full Cone with uniform distribution. For square patterns, please contact BETE.

Spray angles: 60°, 90°, and 120° standard

Flow rates: 2.01 to 2150 gpm (Higher flow rates available)

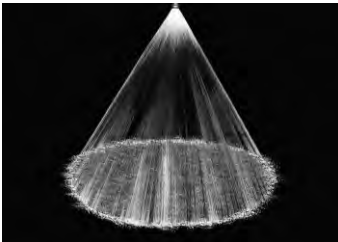

Full Cone 60° (N)

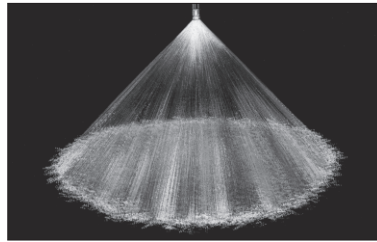

Full Cone 90° (M)



Full Cone 120° (W)

Dimensions are approximate. Check with BETE for critical dimension applications.

NC Flow Rates and Dimensions

Full Cone, Narrow 60°(N), Medium 90°(M) and Wide 120° (W) Spray Angles, 3/4" to 6" Pipe Sizes

Male or Female Pipe Size	Nozzle Number	K Factor	GALLONS PER MINUTE @ PSI									Approx. Orifice Dia. (in.)	Approx. Free Pass. Dia. (in.)	Approximate Dimensions (in.)				Wt. (oz.) Male
			3 PSI	5 PSI	7 PSI	10 PSI	20 PSI	40 PSI	60 PSI	80 PSI	100 PSI			A	B	C	D	
3/4	NC 0703	1.20	2.01	2.56	3.00	3.55	4.91	6.81	8.23	9.43	10.5	0.25	0.16	1.75	1.12	2.12	1.50	1.00
	NC 0704	1.60	2.69	3.41	4.00	4.73	6.55	9.07	11.0	12.6	14.0	0.25	0.19					
	NC 0707	2.80	4.70	5.98	7.00	8.28	11.5	15.9	19.2	22.0	24.4	0.33	0.23					
1	NC 1009	3.61	6.04	7.68	9.00	10.6	14.7	20.4	24.7	28.3	31.4	0.38	0.25	2.19	1.38	2.50	1.75	1.25
	NC 1012	4.81	8.06	10.2	12.0	14.2	19.7	27.2	32.9	37.7	41.9	0.45	0.30					
1 1/4	NC 1214	5.61	9.40	12.0	14.0	16.6	22.9	31.8	38.4	44.0	48.9	0.47	0.34	3.25	1.75	3.25	2.00	3.75
	NC 1217	6.81	11.4	14.5	17.0	20.1	27.8	38.6	46.7	53.4	59.3	0.53	0.38					
1 1/2	NC 1516	6.41	10.7	13.7	16.0	18.9	26.2	36.3	43.9	50.3	55.8	0.50	0.38	4.25	2.00	4.25	2.50	6.75
	NC 1520	8.01	13.4	17.1	20.0	23.7	32.8	45.4	54.9	62.8	69.8	0.56	0.41					
	NC 1524	9.62	16.1	20.5	24.0	28.4	39.3	54.4	65.9	75.4	83.8	0.61	0.44					
2	NC 2017	6.81	11.4	14.5	17.0	20.1	27.8	38.6	46.7	53.4	59.3	0.53	0.38	5.81	2.50	5.81	3.00	12.7
	NC 2020	8.01	13.4	17.1	20.0	23.7	32.8	45.4	54.9	62.8	69.8	0.56	0.41					
	NC 2033	13.2	22.2	28.2	33.0	39.0	54.1	74.9	90.6	104	115	0.72	0.55					
	NC 2040	16.0	26.9	34.1	40.0	47.3	65.5	90.7	110	126	140	0.80	0.63					
	NC 2045	18.0	30.2	38.4	45.0	53.2	73.7	102	124	141	157	0.84	0.63					

$$\text{Flow Rate (GPM)} = K (\text{PSI})^{0.47}$$

Standard Materials: PVC, Polypropylene, and PTFE.

NOTE for PTFE nozzles: if operating temperature is to exceed 300°F, or the operating pressure is to exceed the values listed in the table above, please contact BETE Applications Engineering for assistance.

Spray angle performance varies with pressure. Contact BETE for specific data on critical applications.



Female 120°

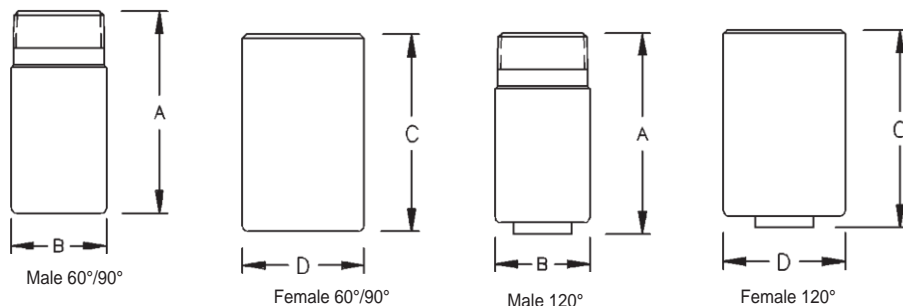

Dimensions are approximate. Check with BETE for critical dimension applications.

NC Flow Rates and Dimensions

Full Cone, Narrow 60° (N), Medium 90° (M) and Wide 120° (W) Spray Angles, 3/4" to 6" Pipe Sizes

Male or Female Pipe Size	Nozzle Number	K Factor	GALLONS PER MINUTE @ PSI									Approx. Orifice Dia. (in.)	Approx. Free Pass. Dia. (in.)	Approximate Dimensions (in.)				Wt. (lbs.) Male
			3 PSI	5 PSI	7 PSI	10 PSI	20 PSI	40 PSI	60 PSI	80 PSI	100 PSI			A	B	C	D	
2	NC 2050	20.0	33.6	42.7	50.0	59.1	81.9	113	137	157	174	0.89	0.60	5.81	2.50	5.81	3.00	0.79
	NC 2060	24.0	40.3	51.2	60.0	71.0	98.3	136	165	189	209	0.94	0.63					
	NC 2065	26.0	43.6	55.5	65.0	76.9	106	147	178	204	227	1.00	0.67					
	NC 2070	28.1	47.0	59.8	70.0	82.8	115	159	192	220	244	1.05	0.68					
2 1/2	NC 2570	28.1	47.0	59.8	70.0	82.8	115	159	192	220	244	1.05	0.68	5.88	3.00	5.88	3.50	1.23
	NC 2580	32.1	53.7	68.3	80.0	94.6	131	181	220	251	279	1.13	0.69					
	NC 2590	36.1	60.4	76.8	90.0	106	147	204	247	283	314	1.19	0.78					
3	NC 3058	23.2	38.9	49.5	58.0	68.6	95.0	132	159	182	202	0.95	0.63	5.88	3.50	5.88	4.00	1.42
	NC 3084	33.7	56.4	71.7	84.0	99.3	138	191	231	264	293	1.17	0.88					
	NC 3096	38.5	64.5	82.0	96.0	114	157	218	264	302	335	1.12	0.95					
	NC 30117	46.9	78.6	99.9	117	138	192	265	321	368	408	1.36	0.97					
4	NC 40125	50.1	83.9	107	125	148	205	284	343	393	436	1.39	0.98	5.88	4.50	7.25	5.00	2.90
	NC 40130	52.1	87.3	111	130	154	213	295	357	409	454	1.42	1.00					
	NC 40180	72.1	121	154	180	213	295	408	494	566	628	1.69	1.31					
	NC 40250	100	168	213	250	296	409	567	686	786	872	1.98	1.586					
6	NC 60350	140	235	299	350	414	573	794	961	1100	1220	2.38	1.70	9.50	6.63	11.0	7.19	8.12
	NC 60480	192	322	410	480	568	786	1090	1320	1510	1670	2.75	1.75					
	NC 60615	246	413	525	615	727	1010	1390	1690	1930	2150	3.11	1.97					

Flow Rate (GPM) = K (PSI)^{0.47}

Standard Materials: PVC, Polypropylene and PTFE.

NOTE for PTFE nozzles: if operating temperature is to exceed 300°F, or the operating pressure is to exceed the values listed in the table above, please contact BETE Applications Engineering for assistance.

Spray angle performance varies with pressure. Contact BETE for specific data on critical applications.

NCS

Stubbies/Minimize Head Space

DESIGN FEATURES

- Takes no more room than pipe plug, yet performs like full-size nozzle
- Small projection
- Can be used with standard pipe couplings to form female nozzle, with elbows to form right angle nozzle, or with tees or crosses for multiple installations
- Male connection
- Metal and plastic materials

SPRAY CHARACTERISTICS

- Spray pattern:** Full Cone
Spray angles: 70°, 90°, and 110° standard
Flow rates: 2.0 to 419 gpm (Special flow rates available)

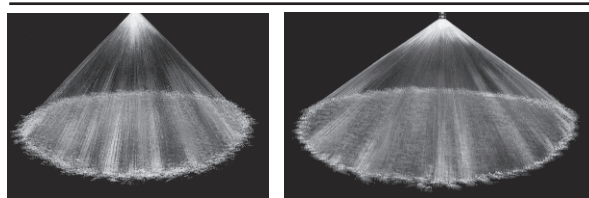

Full Cone 90° (M)

Full Cone 110° (W)

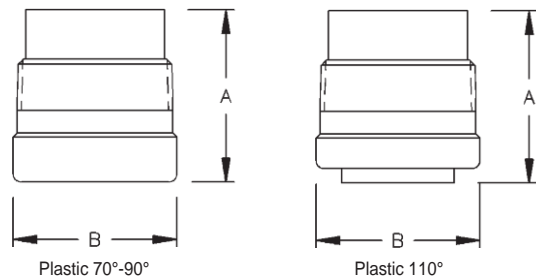

Dimensions are approximate. Check with BETE for critical dimension applications.

NCS Flow Rates and Dimensions

Full Cone, Narrow 70° (N), Medium 90° (M) and Wide 110° (W) Spray Angles, 1" to 4" Pipe Sizes

Male Pipe Size	Nozzle Number	K Factor	GALLONS PER MINUTE @ PSI									Approx. Orifice Dia. (in.)	Approx. Free Pass. Dia. (in.)	Dim. (in.)		Wt. (oz.) PVC
			3 PSI	5 PSI	7 PSI	10 PSI	20 PSI	40 PSI	60 PSI	80 PSI	100 PSI			A	B	
1	NCS1003	1.20	2.01	2.56	3.00	3.55	4.91	6.81	8.23	9.43	10.5	0.22	0.15	1.88	1.38	1.50
	NCS1005	2.00	3.36	4.27	5.00	5.91	8.19	11.3	13.7	15.7	17.4	0.28	0.22			
	NCS1007	2.81	4.70	5.98	7.00	8.28	11.5	15.9	19.2	22.0	24.4	0.33	0.21			
1 1/2	NCS1510	4.01	6.72	8.54	10.0	11.8	16.4	22.7	27.4	31.4	34.9	0.41	0.28	2.38	2.00	3.00
	NCS1513	5.21	8.73	11.1	13.0	15.4	21.3	29.5	35.7	40.9	45.4	0.45	0.38			
	NCS1516	6.41	10.7	13.7	16.0	18.9	26.2	36.3	43.9	50.3	55.8	0.50	0.36			
2	NCS2020	8.01	13.4	17.1	20.0	23.7	32.8	45.4	54.9	62.8	69.8	0.56	0.41	2.63	2.50	6.00
	NCS2025	10.0	16.8	21.3	25.0	29.6	40.9	56.7	68.6	78.6	87.2	0.64	0.45			
	NCS2030	12.0	20.1	25.6	30.0	35.5	49.1	68.1	82.3	94.3	105	0.69	0.52			
	NCS2035	14.0	23.5	29.9	35.0	41.4	57.3	79.4	96.1	110	122	0.75	0.55			
2 1/2	NCS2540	16.0	26.9	34.1	40.0	47.3	65.5	90.7	110	126	140	0.8	0.63	3.00	3.00	9.00
	NCS2545	18.0	30.2	38.4	45.0	53.2	73.7	102	124	141	157	0.84	0.63			
	NCS2550	20.0	33.6	42.7	50.0	59.1	81.9	113	137	157	174	0.89	0.63			
3	NCS3060	24.0	40.3	51.2	60.0	71.0	98.3	136	165	189	209	0.94	0.63	3.31	3.50	14.0
	NCS3070	28.0	47.0	59.8	70.0	82.8	115	159	192	220	244	1.05	0.58			
	NCS3085	34.0	57.1	72.6	85.0	101	139	193	233	267	297	1.16	0.66			
4	NCS40100	40.1	67.2	85.4	100	118	164	227	274	314	349	1.25	0.95	4.00	4.50	20.0
	NCS40120	48.1	80.6	102	120	142	197	272	329	377	419	1.38	1.00			

Flow Rate (GPM) = K (PSI)^{0.47}

Standard Materials: Brass, 316 Stainless Steel, Polypropylene, PVC and PTFE.

Spray angle performance varies with pressure. Contact BETE for specific data on critical applications.

NCK

Full Cone/Narrow Angle Injector

DESIGN FEATURES

- Narrow spray angles
- High velocity
- Male and female connections
- Flanged connections available

SPRAY CHARACTERISTICS

- Coarse and extremely hard driving spray with even distribution

Spray pattern: Full Cone

Spray angles: 15°, 20° and 30°

Flow rates: 7.1 to 1220 gpm
(Special flow rates available)



Plastic

Metal

FULL CONE

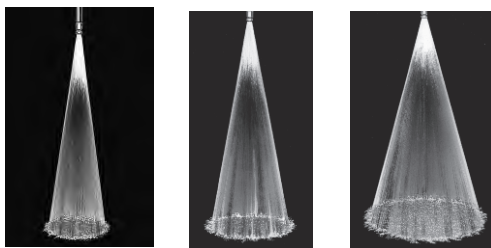

Full Cone 15°

Full Cone 20°

Full Cone 30°

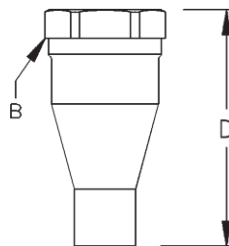

Female

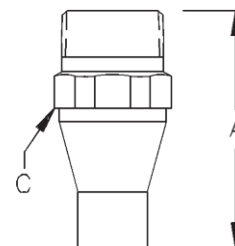

Male

Dimensions are approximate. Check with BETE for critical dimension applications.

NCK Flow Rates and Dimensions

Full Cone, 15°, 20° and 30° Spray Angles, 3/4" to 6" Pipe Sizes

Male or Female Pipe Size	Nozzle Number	K Factor	GALLONS PER MINUTE @ PSI							Approx. Orifice Dia. (in.)	Dimensions for Metal Only (in.)				Wt. (lbs.)	
			10 PSI	20 PSI	30 PSI	40 PSI	60 PSI	80 PSI	100 PSI		A	B	C	D	PVC	Metal
3/4	NC 0706K	2.40	7.10	9.83	11.9	13.6	16.5	18.9	20.9	0.30	3.25	1.38	1.12	3.25	0.09	0.75
1	NC 1012K	4.81	14.2	19.7	23.8	27.2	32.9	37.7	41.9	0.41	3.50	1.75	1.38	3.50	0.12	1.00
1 1/4	NC 1218K	7.21	21.3	29.5	35.7	40.8	49.4	56.6	62.8	0.48	4.00	2.00	1.75	4.00	0.25	1.25
1 1/2	NC 1526K	10.4	30.7	42.6	51.5	59.0	71.4	81.7	90.7	0.60	5.00	2.50	2.00	5.00	0.44	2.25
2	NC 2048K	19.2	56.8	78.6	95.1	109	132	151	168	0.80	6.00	3.00	2.50	6.00	0.82	2.50
2 1/2	NC 2572K	28.8	85.1	118	143	163	198	226	251	0.97	7.00	3.25	3.00	7.63	1.37	5.75
3	NC 30105K	42.1	124	172	208	238	288	330	366	1.16	8.00	3.84	3.50	8.00	1.87	6.25
4	NC 40190K	76.1	225	311	377	431	522	597	663	1.60	9.88	5.00	4.50	10.94	4.50	15.0
6	NC 60350K	140	414	573	694	794	961	1100	1220	2.13	13.5	7.19	6.62	15.0	6.12	35.0

Flow Rate (GPM) = K(PSI)^{0.47}

Standard Materials: Brass, 316 Stainless Steel, PVC, Polypropylene, and PTFE.

NOTE for PTFE nozzles: if operating temperature is to exceed 300°F, or the operating pressure is to exceed the values listed in the table above, please contact BETE Applications Engineering for assistance.

Spray angle performance varies with pressure. Contact BETE for specific data on critical applications.

CALL 413-772-0846
Call for the name of your nearest BETE representative.

NCFL



Plastic Flanged

Flange Connection/Plastic Material

DESIGN FEATURES

- Large internal passages
- Uniform spray coverage
- High flow rates with coarse atomization
- Variety of polymer materials available, offering high corrosion resistance
- For metal alloy nozzles refer to SC (pp. 32, 33) and TC (p. 39).

SPRAY CHARACTERISTICS

Spray pattern: Full Cone
Spray angles: 60°, 90°, and 120°
Flow rates: 94 to 4360 gpm
 (Special flow rates available)

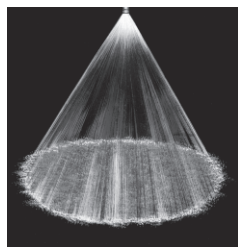

Full Cone 60° (N)



Full Cone 120° (W)

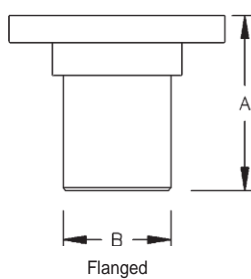

Flanged

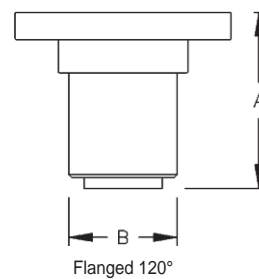

Flanged 120°

Dimensions are approximate. Check with BETE for critical dimension applications.

NCFL Flow Rates and Dimensions

Full Cone, Narrow 60° (N), Medium 90° (M) and Wide 120° (W) Spray Angles, Flanged Connection*

Pipe Size	Nozzle Number	K Factor	GALLONS PER MINUTE @ PSI							Approx. Free Pass.		Dim. (in.)		Wt. PVC (lbs.)
			3 PSI	5 PSI	7 PSI	10 PSI	12 PSI	15 PSI	20 PSI	Orifice Dia. (in.)	Pass. Dia. (in.)	A	B	
4	NCFL40140	56.1	94.0	120	140	166	180	200	229	1.48	1.00	6.30	4.50	8.0
	NCFL40180	72.1	121	154	180	213	232	258	295	1.69	1.31			
	NCFL40250	100	168	213	250	296	322	358	409	1.98	1.58			
6	NCFL60350	140	235	299	350	414	451	501	573	2.38	1.70	10.0	6.62	14
	NCFL60480	192	322	410	480	568	618	687	786	2.75	1.75			
	NCFL60615	246	413	525	615	727	792	880	1010	3.11	1.97			
8	NCFL80665	266	447	568	665	786	857	951	1090	3.25	2.12	12.0	8.62	26
	NCFL80775	311	520	662	775	916	998	1110	1270	3.52	2.38			
	NCFL80885	355	594	756	885	1050	1140	1270	1450	3.75	2.62			
12	NCFL1201280	513	860	1090	1280	1510	1650	1830	2100	4.50	2.88	18.0	12.7	70
	NCFL1201910	765	1280	1630	1910	2260	2460	2730	3130	5.50	3.25			
	NCFL1202665	1070	1790	2270	2665	3150	3430	3810	4360	6.25	3.50			

Flow Rate (GPM) = K (PSI)^{0.47} *150# flange standard; other options available upon request.

Standard Materials: PVC, Polypropylene, and PTFE (12" NCFL not available in PTFE).

Spray angle performance varies with pressure. Contact BETE for specific data on critical applications.

TO ORDER: specify pipe size, connection type, nozzle number, spray angle, and material.

TC

High Flow Rate/Metal Alloy

DESIGN FEATURES

- One-piece body with integral vanes
- Male, female and flanged connections available

SPRAY CHARACTERISTICS

- Extremely high flow rates
- Spray pattern:** Uniform Full Cone
- Spray angles:** 60°, 90°, and 120°
- Flow rates:** 217 to 8730 gpm (Special flow rates available)



Flanged



FULL CONE

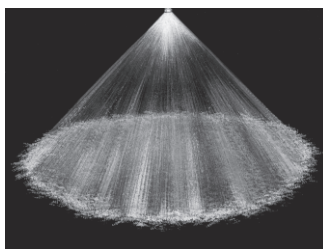

Full Cone 90° (M)

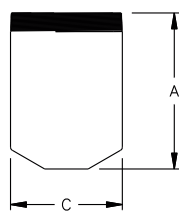

Male 60°/90°

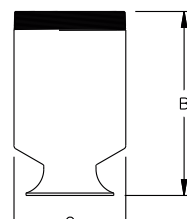

Male 120°

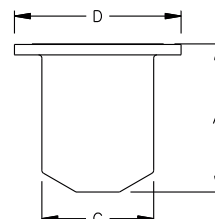

60°/90° Flanged

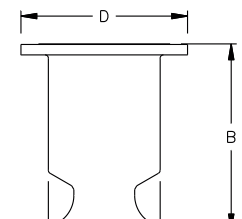

120° Flanged

Dimensions are approximate. Check with BETE for critical dimension applications.

TC Flow Rates and Dimensions

Full Cone, Narrow 60° (N), Medium 90°(M) and Wide 120°(W) Spray Angles, 6" to 12" Pipe Sizes

Male or Female Pipe Size	Available Spray Angles	Nozzle Number	K Factor	GALLONS PER MINUTE @ PSI										Approx. Free Pass. Dia. (in.)	Dimensions (in.)				Wt. (lbs.)
				1 PSI	3 PSI	5 PSI	7 PSI	10 PSI	15 PSI	20 PSI	30 PSI	40 PSI	60 PSI		60° 90° A	120° B	C	D	
6	60° 90° 120°	TC 532	217	217	360	456	532	627	755	862	1040	1190	1430	1.75	10.2	6.60		25	
	90° 120°	TC 588	240	240	398	504	588	693	835	953	1150	1310	1580		10.2	6.60		25	
	90° 120°	TC 827	338	338	560	708	827	974	1170	1340	1610	1840	2220		10.3	12.3	6.60	25	
8	60° 90° 120°	TC 962	393	393	651	824	962	1130	1370	1560	1880	2140	2580	2.06	12.8	8.60		40	
	90° 120°	TC 1120	458	458	758	959	1120	1320	1590	1810	2190	2500	3010		12.8	15.3	8.60	40	
	60° 90° 120°	TC 1260	515	515	853	1080	1260	1480	1790	2040	2460	2810	3380		12.8	15.3	8.60	40	
	90° 120°	TC 1480	605	605	1000	1270	1480	1740	2100	2400	2890	3300	3980			15.3	8.60	40	
Flanged Connection																			
6	60° 90° 120°	TCFL532	217	217	360	456	532	627	755	862	1040	1190	1430	1.75	9.4	6.60		60	
	90° 120°	TCFL588	240	240	398	504	588	693	835	953	1150	1310	1580		9.4	6.60	11.0		
	90° 120°	TCFL827	338	338	560	708	827	974	1170	1340	1610	1840	2220		9.4	11.5	6.60		
8	60° 90° 120°	TCFL962	393	393	651	824	962	1130	1370	1560	1880	2140	2580	2.06	11.9	8.60		85	
	90° 120°	TCFL1120	458	458	758	959	1120	1320	1590	1810	2190	2500	3010		11.9	14.7	8.60		
	60° 90° 120°	TCFL1260	515	515	853	1080	1260	1480	1790	2040	2460	2810	3380		11.9	14.7	8.60		
	90° 120°	TCFL1480	605	605	1000	1270	1480	1740	2100	2400	2890	3300	3980		11.9	14.7	8.60		
12	60° 90°	TCFL2070	846	846	1400	1770	2070	2440	2940	3350	4040	4610	5560	2.25	17.0	12.7		160	
	90°	TCFL2360	960	960	1590	2010	2360	2770	3340	3810	4590	5240	6310		17.0	12.7			
	90° 120°	TCFL2510	1025	1030	1700	2150	2510	2960	3560	4070	4900	5600	6740		17.0	21.4	12.7		
	90° 120°	TCFL2660	1087	1090	1800	2280	2660	3130	3780	4310	5190	5930	7150		17.0	21.4	12.7		
	90°	TCFL2960	1209	1210	2000	2540	2960	3490	4200	4800	5780	6600	7950		17.0	21.4	12.7		
	90°	TCFL3250	1328	1330	2200	2780	3250	3830	4610	5270	6350	7250	8730	17.0	12.7				

$$\text{Flow Rate (GPM)} = K (\text{PSI})^{0.46}$$

Standard Materials: 316 Stainless Steel

Spray angle performance varies with pressure. Contact BETE for specific data on critical applications.

WT

HOLLOW CONE

Right Angle/Hollow Cone

DESIGN FEATURES

- Conventional design using tangential whirl method of atomization
- Durable
- Use where a circular pattern is required or in large area multiple installations where there is considerable overlapping of sprays
- Male and female connections
- Large free passage

SPRAY CHARACTERISTICS

Spray pattern: Hollow Cone
Spray angles: 70° to 120°
Flow rates: 0.04 to 38.0 gpm

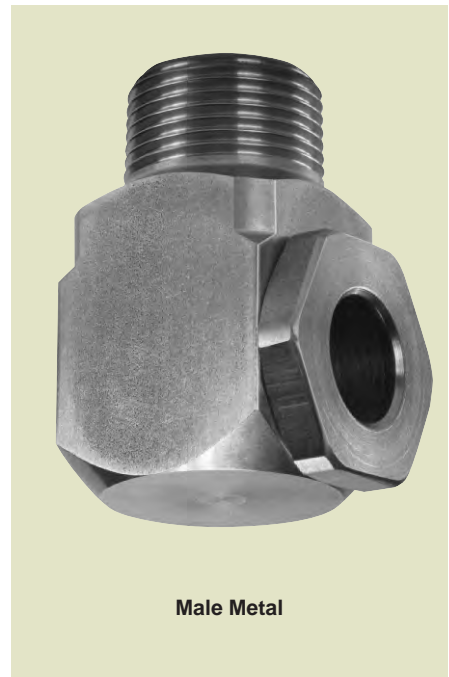

Male Metal

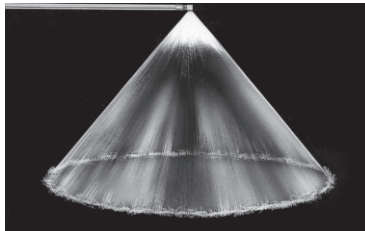

Hollow Cone 80°

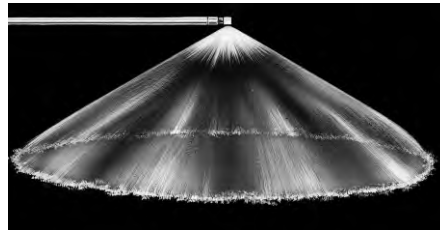

Hollow Cone 120°

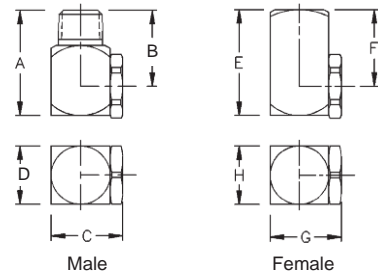

Male

Female

Dimensions are approximate. Check with BETE for critical dimension applications.

WT Flow Rates and Dimensions

Hollow Cone, Medium and Extra Wide Spray Angles, 1/8" to 3/4" Pipe Sizes

Male or Female Pipe Size	Nozzle Number	Spray Angle	K Factor	GALLONS PER MINUTE @ PSI								Approx. (in.)		Dimensions for Metal Only (in.)								Wt. (oz.)	
				5 PSI	10 PSI	20 PSI	30 PSI	40 PSI	60 PSI	80 PSI	100 PSI	Inlet Dia.	Orifice Dia.	A	B	C	D	E	F	G	H	Metal	Plas.
1/8	WT10	70° 110°	0.0158	0.04	0.05	0.07	0.09	0.10	0.12	0.14	0.16	0.04	0.05	1.12	0.88	0.63	0.50	1.00	0.75	0.65	0.50	1.00	0.50
	WT20	70° 115°	0.0316	0.07	0.10	0.14	0.17	0.20	0.24	0.28	0.32	0.06	0.06										
	WT40	70°	0.0632	0.14	0.20	0.28	0.35	0.40	0.49	0.57	0.63	0.09	0.09										
	WT50	115°	0.0791	0.18	0.25	0.35	0.43	0.50	0.61	0.71	0.79	0.09	0.09										
	WT60	70° 115°	0.0949	0.21	0.30	0.42	0.52	0.60	0.73	0.85	0.95	0.10	0.11										
	WT70	115°	0.111	0.25	0.35	0.49	0.61	0.70	0.86	0.99	1.11	0.10	0.11										
	WT80	120°	0.126	0.28	0.40	0.57	0.69	0.80	0.98	1.13	1.26	0.11	0.12										
	WT100	70° 115°	0.158	0.35	0.50	0.71	0.87	1.00	1.22	1.41	1.58	0.13	0.13										
	WT130	120°	0.206	0.46	0.65	0.92	1.13	1.30	1.59	1.84	2.06	0.14	0.14										
	WT160	70°	0.253	0.57	0.80	1.13	1.39	1.60	1.96	2.26	2.53	0.15	0.16										
	WT180	120°	0.285	0.64	0.90	1.27	1.56	1.80	2.20	2.55	2.85	0.17	0.16										
	WT200	70°	0.316	0.71	1.00	1.41	1.73	2.00	2.45	2.83	3.16	0.17	0.19										
1/4	WT12	80°	0.0190	0.04	0.06	0.08	0.10	0.12	0.15	0.17	0.19	0.04	0.05	1.31	1.00	0.79	0.63	1.12	0.81	0.79	0.63	1.75	0.50
	WT18	80°	0.0285	0.06	0.09	0.13	0.16	0.18	0.22	0.25	0.28	0.06	0.06										
	WT20	70° 110°	0.0316	0.07	0.10	0.14	0.17	0.20	0.24	0.28	0.32	0.06	0.06										
	WT27	80°	0.0427	0.10	0.14	0.19	0.23	0.27	0.33	0.38	0.43	0.07	0.08										
	WT35	100°	0.0553	0.12	0.18	0.25	0.30	0.35	0.43	0.49	0.55	0.08	0.09										
	WT40	70° 80°	0.0632	0.14	0.20	0.28	0.35	0.40	0.49	0.57	0.63	0.08	0.09										
	WT42	120°	0.0664	0.15	0.21	0.30	0.36	0.42	0.51	0.59	0.66	0.08	0.09										
	WT48	105°	0.0759	0.17	0.24	0.34	0.42	0.48	0.59	0.68	0.76	0.09	0.11										

$$\text{Flow Rate (GPM)} = K \sqrt{\text{PSI}}$$

Standard Materials: Brass, 303 Stainless Steel, 316 Stainless Steel.

Spray angle performance varies with pressure. Contact BETE for specific data on critical applications.

www.BETE.com

WTX



HOLLOW CONE

Extended Life/Hollow Cone

DESIGN FEATURES

- Tangential whirl
- Oversized body for extended life
- Male and female connections
- Large free passage

SPRAY CHARACTERISTICS

Spray pattern: Hollow Cone
Spray angles: 70° to 140°
Flow rates: 0.04 to 38.0 gpm



Metal

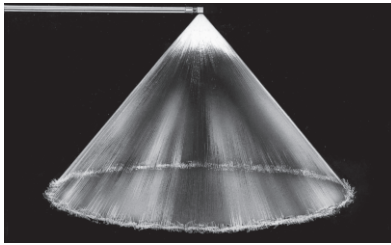

Hollow Cone 80°

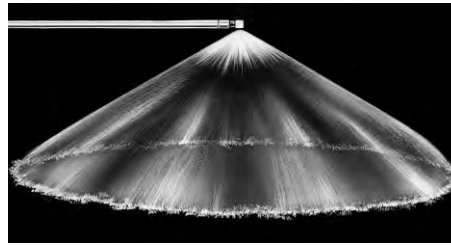

Hollow Cone 120°

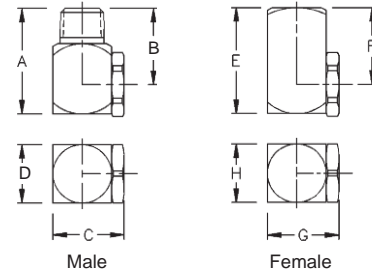

Dimensions are approximate. Check with BETE for critical dimension applications.

WTX Flow Rates and Dimensions

Hollow Cone, Medium and Extra Wide Spray Angles, 1/8" to 3/4" Pipe Sizes

Male or Female Pipe Size	Nozzle Number	Spray Angle	K Factor	GALLONS PER MINUTE @ PSI								Approx. (in.)		Dimensions for Metal Only (in.)								WT. (oz.) Metal
				5 PSI	10 PSI	20 PSI	30 PSI	40 PSI	60 PSI	80 PSI	100 PSI	Inlet Dia.	Orifice Dia.	A	B	C	D	E	F	G	H	
1/8	WTX10	70° 110°	0.0158	0.04	0.05	0.07	0.09	0.10	0.12	0.14	0.16	0.04	0.05	1.12	0.88	0.88	0.75	1.00	0.75	0.88	0.75	1.13
	WTX20	70° 115°	0.0316	0.07	0.10	0.14	0.17	0.20	0.24	0.28	0.32	0.06	0.06									
	WTX40	70°	0.0632	0.14	0.20	0.28	0.35	0.40	0.49	0.57	0.63	0.09	0.09									
	WTX50	115°	0.0791	0.18	0.25	0.35	0.43	0.50	0.61	0.71	0.79	0.09	0.09									
	WTX60	70° 115°	0.0949	0.21	0.30	0.42	0.52	0.60	0.73	0.85	0.95	0.10	0.11									
	WTX70	115°	0.111	0.25	0.35	0.49	0.61	0.70	0.86	0.99	1.11	0.10	0.11									
	WTX80	120°	0.126	0.28	0.40	0.57	0.69	0.80	0.98	1.13	1.26	0.11	0.12									
	WTX100	70° 115°	0.158	0.35	0.50	0.71	0.87	1.00	1.22	1.41	1.58	0.13	0.13									
	WTX130	120°	0.206	0.46	0.65	0.92	1.13	1.30	1.59	1.84	2.06	0.14	0.14									
	WTX160	70°	0.253	0.57	0.80	1.13	1.39	1.60	1.96	2.26	2.53	0.15	0.16									
	WTX180	120°	0.285	0.64	0.90	1.27	1.56	1.80	2.20	2.55	2.85	0.17	0.16									
WTX200	70°	0.316	0.71	1.00	1.41	1.73	2.00	2.45	2.83	3.16	0.17	0.19										
1/4	WTX12	80°	0.0190	0.04	0.06	0.08	0.10	0.12	0.15	0.17	0.19	0.04	0.05	1.31	1.00	0.88	0.75	1.12	0.81	0.88	0.75	2.61
	WTX18	80°	0.0285	0.06	0.09	0.13	0.16	0.18	0.22	0.25	0.28	0.06	0.06									
	WTX20	70° 110°	0.0316	0.07	0.10	0.14	0.17	0.20	0.24	0.28	0.32	0.06	0.06									
	WTX27	80°	0.0427	0.10	0.14	0.19	0.23	0.27	0.33	0.38	0.43	0.07	0.08									
	WTX35	100°	0.0553	0.12	0.18	0.25	0.30	0.35	0.43	0.49	0.55	0.08	0.09									
	WTX40	70° 80°	0.0632	0.14	0.20	0.28	0.35	0.40	0.49	0.57	0.63	0.08	0.09									
	WTX42	120°	0.0664	0.15	0.21	0.30	0.36	0.42	0.51	0.59	0.66	0.08	0.09									
	WTX48	105°	0.0759	0.17	0.24	0.34	0.42	0.48	0.59	0.68	0.76	0.09	0.11									

$$\text{Flow Rate (GPM)} = K \sqrt{\text{PSI}}$$

Standard Materials: Brass, 303 Stainless Steel, 316 Stainless Steel.

Spray angle performance varies with pressure. Contact BETE for specific data on critical applications.

www.BETE.com

TO ORDER: specify pipe size, connection type, nozzle number, spray angle, and material.



HOLLOW CONE

CW

Low Flow

DESIGN FEATURES

- Standard 3-piece construction
- Optional 50- or 100-mesh strainer (refer to page 115 for additional information)
- Male and female connections
- Interchangeable spray tips

SPRAY CHARACTERISTICS

Spray patterns: Hollow Cone (H)
 For Full Cone, see page 28
Spray angles: 80° and 120°
Flow rates: 0.13 to 1.54 gpm

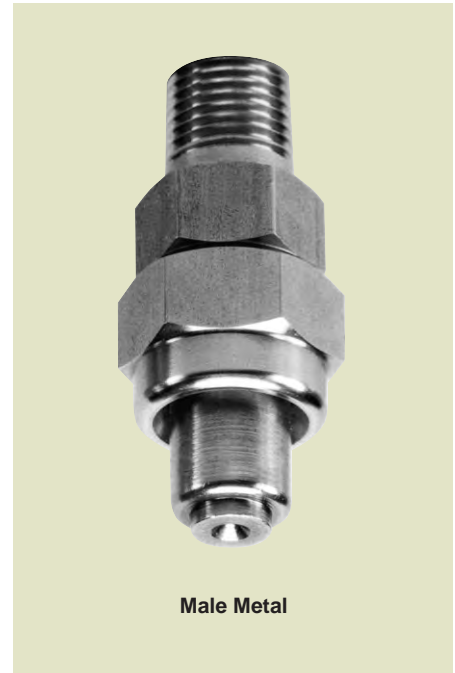

Male Metal



Full Cone 80° (F)



Hollow Cone 80° (H)

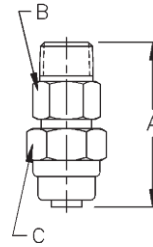

Male

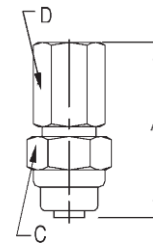

Female

Dimensions are approximate. Check with BETE for critical dimension applications.

CW Flow Rates and Dimensions

Hollow Cone, 80° and 120° Spray Angles, 1/8" to 3/8" Pipe Sizes

Male or Female Pipe Size	Nozzle Number	K Factor	GALLONS PER MINUTE @ PSI										Approx. Orifice Dia. (in.)	Male or Female Pipe Size	Dimensions (in.)				Wt. (oz.) Metal
			10 PSI	20 PSI	30 PSI	40 PSI	50 PSI	60 PSI	70 PSI	80 PSI	90 PSI	100 PSI			A	B	C	D	
1/8 or 1/4	CW25-H	0.044	0.13	0.18	0.22	0.25	0.28	0.30	0.33	0.35	0.37	0.38	0.045	1/8 - 1/4	2.06	0.68	0.81	0.68	2.5
or	CW50-H	0.088	0.26	0.36	0.44	0.50	0.56	0.60	0.65	0.69	0.73	0.77	0.054						
or	CW75-H	0.132	0.39	0.54	0.66	0.75	0.83	0.91	0.98	1.04	1.10	1.15	0.063	3/8	2.06	0.68	0.81	0.81	
3/8	CW100-H	0.177	0.52	0.72	0.87	1.00	1.11	1.21	1.30	1.39	1.46	1.54	0.086						

Flow Rate (GPM) = K (PSI)^{0.47}

Standard Materials: Brass, 303 Stainless Steel and 316 Stainless Steel.

Spray angle performance varies with pressure. Contact BETE for specific data on critical applications.

TO ORDER: specify pipe size, connection type, nozzle number, spray angle, and material.

TFE

Wide Range of Flows and Angles

DESIGN FEATURES

- The original spiral nozzle invented by BETE and continuously improved!
- High energy efficiency
- One-piece/no internal parts
- Clog-resistant performance
- High discharge velocity
- Male connection standard; female connection available by special order

SPRAY CHARACTERISTICS

- Wide range of flow rates and spray angles
 - Fine atomization
- Spray patterns:** Hollow Cone
For Full Cone, see page 20
- Spray angles:** 50° to 180°
- Flow rates:** 0.5 to 3320 gpm
(Higher flow rates available)

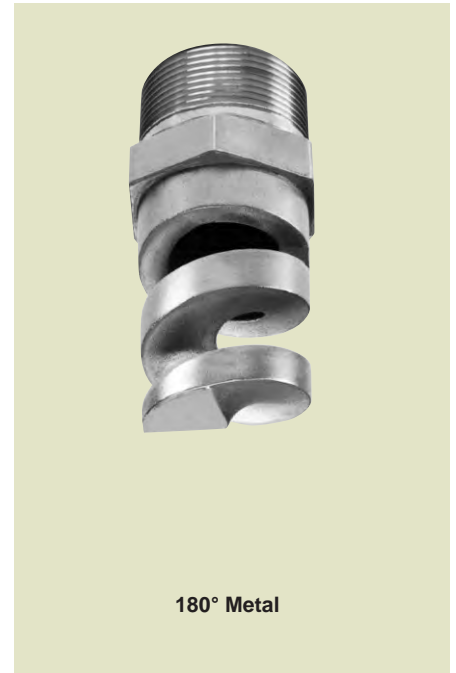

HOLLOW CONE



Hollow Cone 50° (N)



Hollow Cone 120° (W)

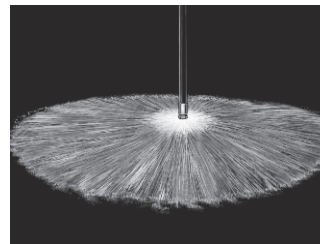

Hollow Cone 180° (XW)

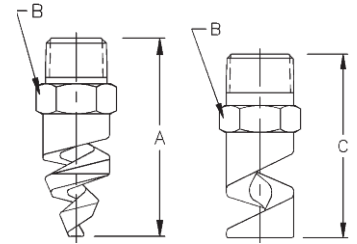

50°, 60°, 90°, 120°

180°

Dimensions are approximate. Check with BETE for critical dimension applications.

TF Hollow Cone Flow Rates and Dimensions

Hollow Cone, 50° (N), 60° (V), 90° (M), 120° (W), and 180° (XW) Spray Angles, 1/4" to 4" Pipe Sizes

Male Pipe Size	Nozzle Number	Available Spray Angles					K Factor	GALLONS PER MINUTE @ PSI														Approx. (in.)		Dim. (in.) for Metal Only*			Wt. (oz.) 180° Metal Plas.	
		50°	60°	90°	120°	180°		5 PSI	10 PSI	20 PSI	30 PSI	40 PSI	50 PSI	60 PSI	80 PSI	100 PSI	200 PSI	400 PSI	Orif. Dia.	Free Pass. Dia.	A	B	C					
1/4	TF6	50°	60°	90°	120°	180°	0.221	0.495	0.70	0.99	1.21	1.40	1.57	1.71	1.98	2.21	3.13	4.43	0.09	0.09	1.88	0.56	1.88	1.25	0.25			
	TF8	50°	60°	90°	120°	180°	0.411	0.919	1.30	1.84	2.25	2.60	2.91	3.18	3.68	4.11	5.81	8.22	0.13	0.13	1.88	0.56	1.88					
	TF10	50°	60°	90°	120°	180°	0.632	1.41	2.00	2.83	3.46	4.00	4.47	4.90	5.66	6.32	8.94	12.6	0.16	0.13	1.88	0.56	1.88					
3/8	TF12	50°	60°	90°	120°	180°	0.949	2.12	3.00	4.24	5.20	6.00	6.71	7.35	8.49	9.49	13.4	19.0	0.19	0.13								
	TF14	50°	60°	90°	120°	180°	1.28	2.86	4.05	5.73	7.01	8.10	9.06	9.92	11.5	12.8	18.1	25.6	0.22	0.13	1.88	0.69	1.88	1.75	0.25			
	TF16	50°	60°	90°	120°	180°	1.68	3.75	5.30	7.50	9.18	10.6	11.9	13.0	15.0	16.8	23.7	33.5	0.25	0.13								
	TF20	50°	60°	90°	120°	180°	2.61	5.83	8.25	11.7	14.3	16.5	18.4	20.2	23.3	26.1	36.9	52.2	0.31	0.13								
1/2	TF24	50°	60°	90°	120°	180°	3.81	8.52	12.1	17.0	20.9	24.1	26.9	29.5	34.1	38.1	53.9	76.2	0.38	0.19	2.50	0.88 ¹	2.38	3.00	0.50			
	TF28	50°	60°	90°	120°	180°	5.22	11.7	16.5	23.3	28.6	33.0	36.9	40.4	46.7	52.2	73.8	104	0.44	0.19								
3/4	TF32	50°	60°	90°	120°	180°	6.64	14.8	21.0	29.7	36.4	42.0	47.0	51.4	59.4	66.4	93.9	133	0.50	0.19	2.75	1.13	3.00	3.00	1.00			
1	TF40	60°	90°	120°	180°		10.6	23.7	33.5	47.4	58.0	67.0	74.9	82.1	94.8	106	150	212	0.63	0.25	3.63	1.38 ²	3.63	15.0	3.00			
	TF48	60°	90°	120°	180°		15.0	33.6	47.5	67.2	82.3	95.0	106	116	134	150	212	300	0.75	0.25								
1 1/2	TF56	60°	90°	120°	180°		20.4	45.6	64.5	91.2	112	129	144	158	182	204	288	408	0.88	0.31								
	TF64	60°	90°	120°	180°		26.7	59.7	84.5	120	146	169	189	207	239	267	378	534	1.00	0.31	4.38	2.00	4.38	30.0	6.00			
	TF72	60°	90°	120°	180°		30.4	67.9	96.0	136	166	192	215	235	272	304	429	607	1.13	0.31								
2	TF88	60°	90°	120°	180°		44.3	99.0	140	198	242	280	313	343	396	443	626	885	1.38	0.44	5.63	2.50	5.00	46.0	8.00			
	TF96	60°	90°	120°	180°		55.9	125	177	250	306	354	395	433	500	559	791	1120	1.50	0.44	6.88	2.50	5.00	54.0	9.00			
3	TF112	60°	90°	120°			81.0	181	256	362	443	512	572	627	724	810	1150	1620	1.75	0.56	8.63	3.50						
	TF128	60°	90°	120°			107	239	339	480	588	679	759	831	960	1070	1510	2150	2.00	0.56								
4	TF160	60°	90°	120°			166	371	525	742	909	1050	1170	1290	1480	1660	2350	3320	2.50	0.63	10.1	4.50	12.75					

Flow Rate (GPM) = K √PSI

*Dimensions are for bar stock, cast sizes may vary.

¹ 1.00 for 180°

² 1.63 for 180°

Standard Materials: Brass, 316 Stainless Steel, PVC, Polypropylene and PTFE (Poly, not available for TF6 thru TF10).

TF8 and TF 24 150° are Factory Mutual approved. Contact BETE for more information.

Spray angle performance varies with pressure. Contact BETE for specific data on critical applications.

EZ_{TF WT}

EZ Change Quick Connection System

DESIGN FEATURES

- Nozzles can be changed in seconds without tools
- Three part nozzle, base, gasket and interchangeable tip
- Exclusive ramped engagement for efficient, automatic alignment
- Threaded adapters will accommodate other standard BETE nozzles. Shut-off plugs are also available
- Sanitary EZs are available with weld connection and no knurling

SPRAY CHARACTERISTICS

- Available in six standard tips: EZTF; EZWL; EZWT; EZFF; EZNF; EZSPN

More EZ tips:

Full Cone: page 30
Flat Fan: pages 66 and 67

Flow rates: 0.04 to 58.4 gpm

Spray Angle:

EZTF: 60°, 90°, 120°, and 180°
EZWT: 70° and 110°



EZTF



120° Hollow Cone

Dimensions are approximate. Check with BETE for critical dimension applications.

EZTF Flow Rates and Dimensions

Hollow Cone Spiral 60° (V), 90° (M), 120° (W), 180° Spray Angle 1/8" to 1/2" Pipe Sizes

Pipe Size	Nozzle Number	K Factor	GALLONS PER MINUTE @ PSI											Approx. Orifice Dia. (in.)	Approx. Assembly Dim. (in.)		Wt. (oz.)	
			5 PSI	10 PSI	20 PSI	30 PSI	40 PSI	60 PSI	80 PSI	100 PSI	200 PSI	400 PSI	500 PSI		Hex	Length		
1/8" TO 1/2"	EZTF6	0.221	0.49	0.70	0.99	1.21	1.40	1.71	1.98	2.21	3.13	4.43	4.94	0.09	1/8"	0.88	2.41	2.2
	EZTF8	0.411	0.92	1.30	1.84	2.25	2.60	3.18	3.68	4.11	5.81	8.22	9.19	0.13				
1/2"	EZTF10	0.632	1.41	2.00	2.83	3.46	4.00	4.90	5.66	6.32	8.94	12.6	14.1	0.16	1/4"	0.88	2.53	2.2
	EZTF12	0.949	2.12	3.00	4.24	5.20	6.00	7.35	8.49	9.49	13.4	19.0	21.2	0.19				
1/4" TO 1/2"	EZTF14	1.28	2.86	4.05	5.73	7.01	8.10	9.92	11.5	12.8	18.1	25.6	28.6	0.22	3/8"	0.88	2.59	2.6
	EZTF16	1.68	3.76	5.30	7.50	9.18	10.6	13.0	15.0	16.8	23.7	33.5	37.6	0.25				
1/2"	EZTF20	2.61	5.83	8.25	11.7	14.3	16.5	20.2	23.3	26.1	36.9	52.2	58.4	0.31	1/2"	0.88	2.65	2.6

Flow Rate (GPM) = $K \sqrt{PSI}$

TF14-TF20 not available with 1/8" base

Standard Materials: Brass, Viton gaskets standard. 316 Stainless Steel available upon request.

Spray angle performance varies with pressure. Contact BETE for specific data on critical applications.

TO ORDER: specify pipe size, connection type, nozzle number, spray angle, and material.

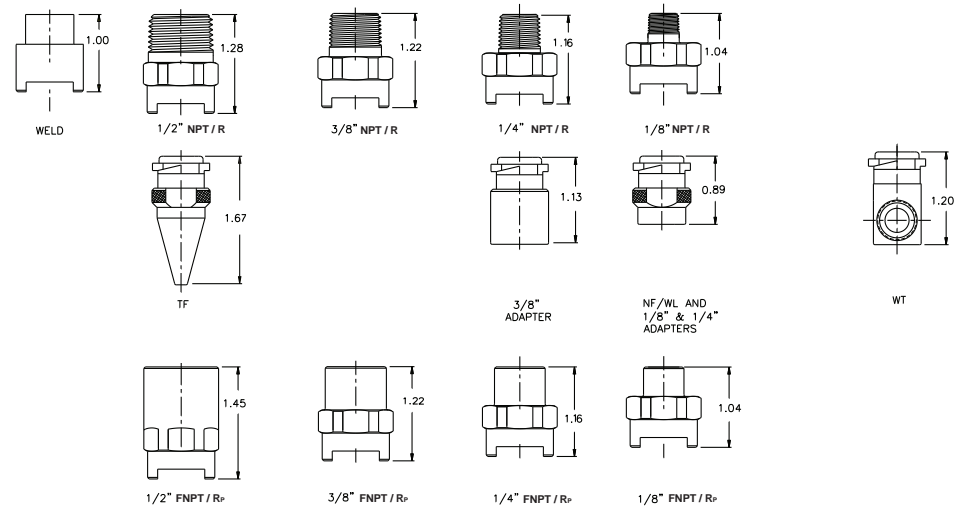

Dimensions are approximate. Check with BETE for critical dimension applications.

EZWT Flow Rates and Dimensions
 Hollow Cone, Narrow (70°) and Wide (110°) Spray Angles 1/8" to 1/2"

Pipe Size	Nozzle Number	K Factor	GALLONS PER MINUTE @ PSI										Approx. Orifice Dia. (in.)	Assembly Dim. (in.)		Wt. (oz.)	
			5 PSI	10 PSI	20 PSI	40 PSI	60 PSI	80 PSI	100 PSI	200 PSI	400 PSI	500 PSI		Hex	Length		
1/8"	EZWT10	0.0158	0.04	0.05	0.07	0.10	0.12	0.14	0.16	0.22	0.32	0.35	0.03	1/8"	0.88	1.99	2.2
	EZWT12	0.0190	0.04	0.06	0.08	0.12	0.15	0.17	0.19	0.27	0.38	0.42	0.03				
	EZWT18	0.0285	0.06	0.09	0.13	0.18	0.22	0.25	0.28	0.40	0.57	0.64	0.05				
	EZWT20	0.0316	0.07	0.10	0.14	0.20	0.24	0.28	0.32	0.45	0.63	0.71	0.06				
	EZWT27	0.0427	0.10	0.14	0.19	0.27	0.33	0.38	0.43	0.60	0.85	0.95	0.05				
	EZWT35	0.0553	0.12	0.18	0.25	0.35	0.43	0.49	0.55	0.78	1.11	1.24	0.06				
	EZWT40	0.0632	0.14	0.20	0.28	0.40	0.49	0.57	0.63	0.89	1.26	1.41	0.08				
	EZWT42	0.0664	0.15	0.21	0.30	0.42	0.51	0.59	0.66	0.94	1.33	1.48	0.06				
	EZWT48	0.0759	0.17	0.24	0.34	0.48	0.59	0.68	0.76	1.07	1.52	1.70	0.06				
	EZWT50	0.0791	0.18	0.25	0.35	0.50	0.61	0.71	0.79	1.12	1.58	1.77	0.08				
TO	EZWT53	0.084	0.19	0.27	0.37	0.53	0.65	0.75	0.84	1.19	1.68	1.87	0.11	1/4"	0.88	2.11	2.2
	EZWT60	0.095	0.21	0.30	0.42	0.60	0.73	0.85	0.95	1.34	1.90	2.12	0.09				
	EZWT68	0.108	0.24	0.34	0.48	0.68	0.83	0.96	1.08	1.52	2.15	2.40	0.13				
	EZWT70	0.111	0.25	0.35	0.49	0.70	0.86	0.99	1.11	1.57	2.21	2.47	0.09				
	EZWT80	0.126	0.28	0.40	0.57	0.80	0.98	1.13	1.26	1.79	2.53	2.83	0.08				
	EZWT100	0.158	0.35	0.50	0.71	1.00	1.22	1.41	1.58	2.24	3.16	3.54	0.13				
	EZWT130	0.206	0.46	0.65	0.92	1.30	1.59	1.84	2.06	2.91	4.11	4.60	0.13				
	EZWT150	0.237	0.53	0.75	1.06	1.50	1.84	2.12	2.37	3.35	4.74	5.30	0.22				
	EZWT160	0.253	0.57	0.80	1.13	1.60	1.96	2.26	2.53	3.58	5.06	5.66	0.16				
	EZWT180	0.285	0.64	0.90	1.27	1.80	2.20	2.55	2.85	4.02	5.69	6.36	0.17				
1/2"	EZWT200	0.316	0.71	1.00	1.41	2.00	2.45	2.83	3.16	4.47	6.32	7.07	0.22	3/8"	0.88	2.17	2.6
	EZWT220	0.348	0.78	1.10	1.56	2.20	2.69	3.11	3.48	4.92	6.96	7.78	0.22				
	EZWT240	0.379	0.85	1.20	1.70	2.40	2.94	3.39	3.79	5.37	7.59	8.49	0.20				
	EZWT260	0.411	0.92	1.30	1.84	2.60	3.18	3.68	4.11	5.81	8.22	9.19	0.22				
	EZWT270	0.427	0.95	1.35	1.91	2.70	3.31	3.82	4.27	6.04	8.54	9.55	0.22				
	EZWT280	0.443	0.99	1.40	1.98	2.80	3.43	3.96	4.43	6.26	8.85	9.90	0.20				
	EZWT300	0.474	1.06	1.50	2.12	3.00	3.67	4.24	4.74	6.71	9.49	10.6	0.25				
	EZWT340	0.538	1.20	1.70	2.40	3.40	4.16	4.81	5.38	7.60	10.8	12.0	0.28				
	EZWT350	0.553	1.24	1.75	2.47	3.50	4.29	4.95	5.53	7.83	11.1	12.4	0.23				
	EZWT400	0.632	1.41	2.00	2.83	4.00	4.90	5.66	6.32	8.94	12.7	14.1	0.25				

Flow Rate (GPM) = $K \sqrt{PSI}$

Standard Materials: 303 Stainless Steel, 316 Stainless Steel, Brass, Viton gaskets standard.

Spray angle performance varies with pressure. Contact BETE for specific data on critical applications.

CALL 413-772-0846
 Call for the name of your nearest BETE representative.

SF

Snap Release Nozzle System

DESIGN FEATURES

- Nozzles can be quickly changed and aligned by hand without tools
- Clamp-on adapter fits any style nozzle
- Quick set-up system features special "Snap-in" tips
- Polypropylene, resistant to most acids and alkalis
- Double clamp base or adapter available for higher pressure operation

SPRAY CHARACTERISTICS

- Quick Set-up System can be provided with fan, hollow or full cone spray tips
- Full 45° alignment of spray without tools

More SF Nozzle Systems:

Full Cone: page 31

Flat Fan: page 68

Flow rates: 0.35 to 15.8 gpm

Spray angles:

Fan: 40°, 50°, 65°, 80°, 95°

Hollow Cone: 50°, 65°, 90°

Full Cone: 35°, 65°, 80°

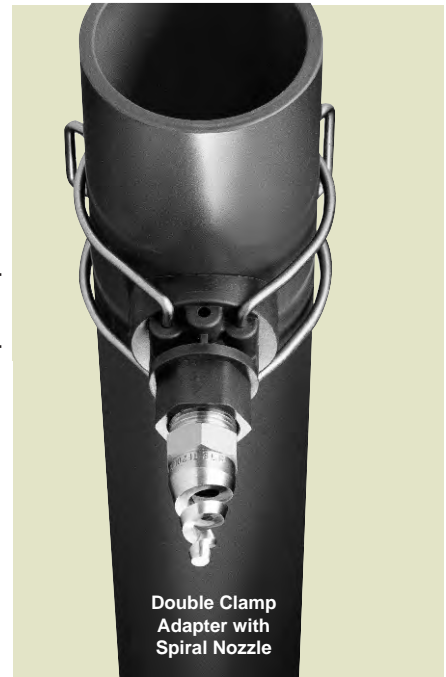

Double Clamp Adapter with Spiral Nozzle

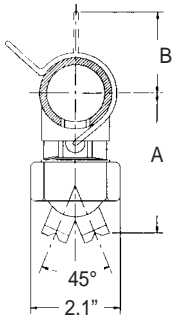

CLAMP-ON ADAPTER

- Available for 1", 1-1/4", 1-1/2" and 2" pipe.
- Available with 1/8", 1/4", 3/8", 1/2" NPT female threads; or 1/8" BSP female threads
- Available with single or double clamp.
- **TO ORDER ADAPTER Specify: Pipe Size, thread size, thread type, number of clamps, materials.**

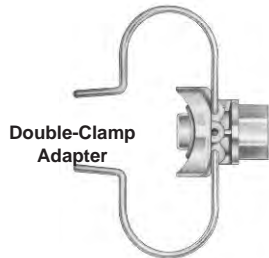

"SNAP-IN" Hollow Cone Nozzle Tip

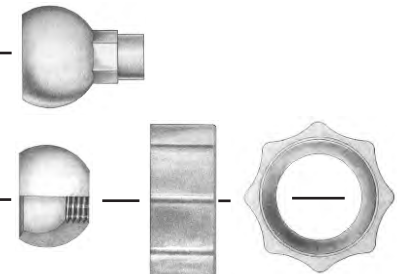

"SNAP-IN" Threaded Swivel Ball

Available with 1/8", 1/4", 3/8", 1/2" NPT or BSP Female threads

Retainer Cap

Dimensions are approximate. Check with BETE for critical dimension applications.

SF Flow Rates and Dimensions

SF Hollow Cone 50°, 65° and 90° Spray Angles 1", 1-1/4", 1-1/2" and 2" Pipe Sizes

Nozzle Number	Available Spray Angle	K Factor	GALLONS PER MINUTE @ PSI								Pipe Size	Body Color	Approx. Dim. (in.)		Wt. (oz.)	
			5 PSI	10 PSI	15 PSI	20 PSI	30 PSI	40 PSI	60 PSI	80 PSI			100 PSI	A		B
SF15HC	90°	0.237	0.53	0.75	0.92	1.06	1.30	1.50	1.84	2.12	2.37	1"	blue	3.3	1.7	2.0
SF58HC	50°	0.917	2.05	2.90	3.55	4.10	5.20	5.80	7.10	8.20	9.17	1-1/4"	red	3.4	1.9	2.2
SF100HC	65°	1.581	3.53	5.00	6.12	7.07	8.65	10.0	12.2	14.1	15.8	1-1/2"	purple	3.6	2.0	2.2
												2"	green	3.7	2.2	2.2

$$\text{Flow Rate (GPM)} = K\sqrt{\text{PSI}}$$

Standard Materials: Polypropylene, 302 Stainless Steel clamp, EPDM seal.

Optional Materials: Viton seal.

NOTE: Drill 21/32" hole in pipe to install SF.

NOTE: Maximum recommended working pressures for SF assemblies: with single clamp, 70 psi for 1" pipe; 50 psi for 1-1/4" and 1-1/2" pipe; and 35 psi for 2" pipe; with double clamp up to 150 psi.

Spray angle performance varies with pressure. Contact BETE for specific data on critical applications.

NCJ

Hollow Cone/Narrow Angle Injector

DESIGN FEATURES

- Narrow spray angles
- High velocity
- Male and female connections
- Flanged connections available
- Available in plastic and metal alloys

SPRAY CHARACTERISTICS

- Spray is coarse and extremely hard-driving
- Spray pattern:** Hollow Cone
Spray angles: 15°, 20° and 30°
Flow rates: 7.1 to 1220 gpm
 (Special flow rates available)



HOLLOW CONE

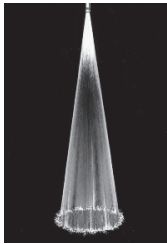

Hollow Cone 15°

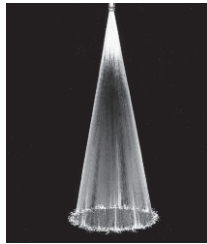

Hollow Cone 20°

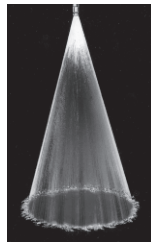

Hollow Cone 30°

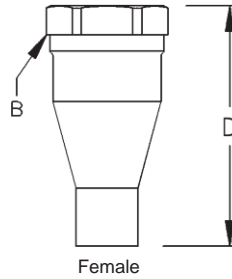

Female

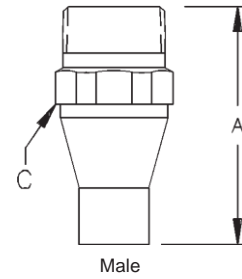

Male

Dimensions are approximate. Check with BETE for critical dimension applications.

NCJ Flow Rates and Dimensions

Hollow Cone, 15°, 20° and 30° Spray Angles, 3/4" to 6" Pipe Sizes

Male or Female Pipe Size	Nozzle Number	K Factor	GALLONS PER MINUTE @ PSI							Approx. Orifice Dia. (in.)	Dimensions for Metal Only (in.)				Wt. (lbs.)	
			10 PSI	20 PSI	30 PSI	40 PSI	60 PSI	80 PSI	100 PSI		A	B	C	D	PVC	Metal
3/4	NC 0706J	2.40	7.10	9.83	11.9	13.6	16.5	18.9	20.9	0.30	3.25	1.38	1.12	3.25	0.09	0.75
1	NC 1012J	4.81	14.2	19.7	23.8	27.2	32.9	37.7	41.9	0.41	3.50	1.75	1.38	3.50	0.12	1.00
1 1/4	NC 1218J	7.21	21.3	29.5	35.7	40.8	49.4	56.6	62.8	0.48	4.00	2.00	1.75	4.00	0.25	1.25
1 1/2	NC 1526J	10.4	30.7	42.6	51.5	59.0	71.4	81.7	90.7	0.60	5.00	2.50	2.00	5.00	0.44	2.25
2	NC 2048J	19.2	56.8	78.6	95.1	109	132	151	168	0.80	6.00	3.00	2.50	6.00	0.82	2.50
2 1/2	NC 2572J	28.8	85.1	118	143	163	198	226	251	0.97	7.00	3.25	3.00	7.63	1.37	5.75
3	NC 30105J	42.1	124	172	208	238	288	330	366	1.16	8.00	3.84	3.50	8.00	1.87	6.25
4	NC 40190J	76.1	225	311	377	431	522	597	663	1.60	9.88	5.00	4.50	10.94	4.50	15.0
6	NC 60350J	140	414	573	694	794	961	1100	1220	2.13	13.5	7.19	6.62	15.0	6.12	35.0

$$\text{Flow Rate (GPM)} = K(\text{PSI})^{0.47}$$

Standard Materials: Brass, 316 Stainless Steel, PVC, Polypropylene, and PTFE.

NOTE for PTFE nozzles: if operating temperature is to exceed 300°F, or the operating pressure is to exceed the values listed in the table above, please contact BETE Applications Engineering for assistance.

Spray angle performance varies with pressure. Contact BETE for specific data on critical applications.

CALL 413-772-0846
 Call for the name of your nearest BETE representative.



TH

Tangential Inlet/Right Angle

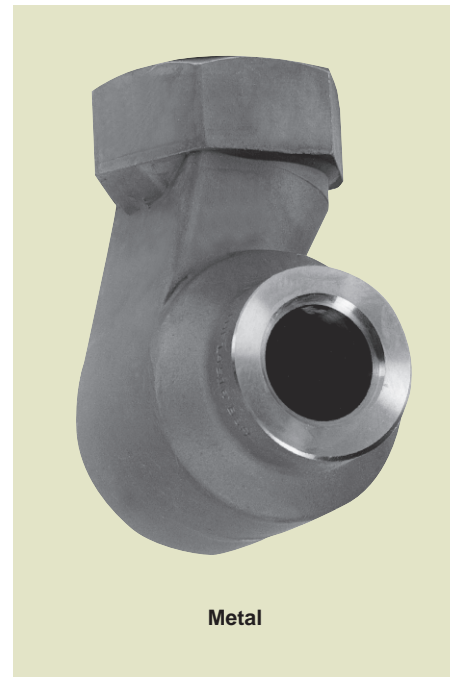

Metal

DESIGN FEATURES

- Large free passage
- Clog-resistant; nozzles have no internal parts
- One-piece casting
- Female connection
- Flanged connection available
- Silicon carbide available upon request
- Inlet and outlet are in-line

SPRAY CHARACTERISTICS

- Patented geometry designed to give the most uniform liquid distribution around the periphery of the spray

Spray pattern: Hollow Cone

Spray angles: Narrow to Medium

Flow rates: 4.11 to 564 gpm

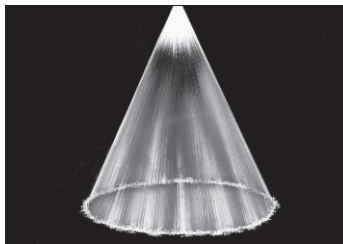

Hollow Cone - Narrow Angle

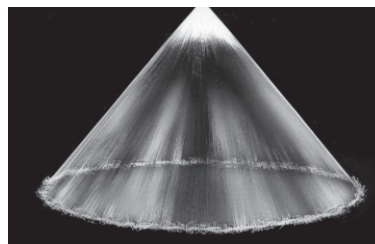

Hollow Cone - Medium Angle

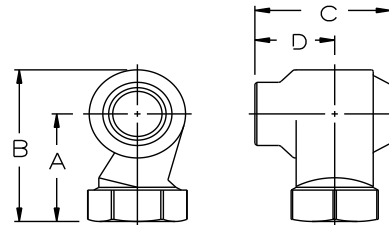

Dimensions are approximate. Check with BETE for critical dimension applications.

TH Flow Rates and Dimensions

Hollow Cone, Narrow to Medium Spray Angles, 1" to 3" Pipe Sizes

Female Pipe Size	Nozzle Number	Spray Ang.			K Factor	GALLONS PER MINUTE @ PSI							Approx. Orifice Dia. (in.)	Free Pass. Dia. (in.)	Dimensions (in.) (MAX)				Wt. (lbs.)	
		5°	15°	40°		3 PSI	5 PSI	7 PSI	10 PSI	15 PSI	20 PSI	30 PSI			40 PSI	A	B	C		D
1	THF1508	54°	54°	54°	2.37	4.11	5.30	6.27	7.50	9.19	10.6	13.0	15.0	0.34	0.34	2.31	3.13	2.33	1.40	1.04
	THF1808	56°	56°	56°	2.85	4.93	6.36	7.53	9.00	11.0	12.7	15.6	18.0	0.38	0.38					
	THF2308	63°	66°	66°	3.64	6.30	8.13	9.62	11.5	14.1	16.3	19.9	23.0	0.44	0.44					
	THF2708	66°	70°	70°	4.27	7.39	9.55	11.3	13.5	16.5	19.1	23.4	27.0	0.47	0.47					
	THF3208	68°	72°	71°	5.06	8.76	11.3	13.4	16.0	19.6	22.6	27.7	32.0	0.44	0.44					
	THF3808	68°	72°	71°	6.01	10.4	13.4	15.9	19.0	23.3	26.9	32.9	38.0	0.60	0.60					
1 1/4	THF3210	66°	66°	66°	5.06	8.76	11.3	13.4	16.0	19.6	22.6	27.7	32.0	0.55	0.55	2.81	3.79	2.86	1.74	1.65
	THF3810	68°	70°	70°	6.01	10.4	13.4	15.9	19.0	23.3	26.9	32.9	38.0	0.63	0.63					
	THF4110	73°	74°	74°	6.48	11.2	14.5	17.2	20.5	25.1	29.0	35.5	41.0	0.66	0.66					
	THF5210	90°	90°	90°	8.22	14.2	18.4	21.8	26.0	31.8	36.8	45.0	52.0	0.78	0.78					
	THF7010	83°	85°	85°	11.1	19.2	24.7	29.3	35.0	42.9	49.5	60.6	70.0	1.03	0.89					
1 1/2	THF6112	58°	60°	60°	9.65	16.7	21.6	25.5	30.5	37.4	43.1	52.8	61.0	0.77	0.77	2.96	4.12	3.43	2.09	1.88
	THF7012	63°	65°	65°	11.1	19.2	24.7	29.3	35.0	42.9	49.5	60.6	70.0	0.84	0.84					
	THF7712	63°	66°	66°	12.2	21.1	27.2	32.2	38.5	47.2	54.4	66.7	77.0	0.92	0.92					
	THF9012	67°	70°	70°	14.2	24.6	31.8	37.6	45.0	55.1	63.6	77.9	90.0	1.03	1.03					
	THF12712	75°	80°	80°	20.1	34.8	44.9	53.1	63.5	77.8	89.8	110	127	1.30	1.06					
	THF14512	80°	80°	83°	22.9	39.7	51.3	60.7	72.5	88.8	103	126	145	1.42	1.06					

$$\text{Flow Rate (GPM)} = K \sqrt{\text{PSI}}$$

Standard Materials: Brass, Carbon Steel, and 316 Stainless Steel.

Spray angle performance varies with pressure. Contact BETE for specific data on critical applications.

TO ORDER: specify pipe size, connection type, nozzle number, spray angle, and material.



Silicon Carbide, Flanged



HOLLOW CONE

Dimensions are approximate. Check with BETE for critical dimension applications.

TH Flow Rates and Dimensions

Hollow Cone, Narrow to Medium Spray Angles, 1" to 3" Pipe Sizes

Female Pipe Size	Nozzle Number	Spray Ang.			K Factor	GALLONS PER MINUTE @ PSI								Approx. Orifice Dia. (in.)	Free Pass. Dia. (in.)	Dimensions (in.) (MAX)				Wt. (lbs.)
		5 PSI	15 PSI	40 PSI		3 PSI	5 PSI	7 PSI	10 PSI	15 PSI	20 PSI	30 PSI	40 PSI			A	B	C	D	
2	THF8516	63°	65°	65°	13.4	23.3	30.1	35.6	42.5	52.1	60.1	73.6	85.0	0.86	0.86	3.64	5.12	4.20	2.44	3.16
	THF10516	65°	67°	67°	16.6	28.8	37.1	43.9	52.5	64.3	74.2	90.9	105	1.00	1.00					
	THF12516	68°	70°	70°	19.8	34.2	44.2	52.3	62.5	76.5	88.4	108	125	1.14	1.14					
	THF14516	74°	79°	79°	22.9	39.7	51.3	60.7	72.5	88.8	103	126	145	1.27	1.27					
	THF17016	77°	80°	80°	26.9	46.6	60.1	71.1	85.0	104	120	147	170	1.39	1.39					
	THF19216	77°	80°	80°	30.4	52.6	67.9	80.3	96.0	118	136	166	192	1.52	1.44					
	THF20516	77°	83°	83°	32.4	56.1	72.5	85.8	103	126	145	178	205	1.63	1.44					
	THF23016	76°	83°	83°	36.4	63.0	81.3	96.2	115	141	163	199	230	1.75	1.44					
2 1/2	THF17020	85°	85°	85°	26.9	46.6	60.1	71.1	85.0	104	120	147	170	1.33	1.33	4.94	6.79	5.19	3.03	6.48
	THF19020	70°	73°	73°	30.0	52.0	67.2	79.5	95.0	116	134	165	190	1.42	1.42					
	THF20520	72°	75°	73°	32.4	56.1	72.5	85.8	103	126	145	178	205	1.47	1.47					
	THF23020	76°	78°	78°	36.4	63.0	81.3	96.2	115	141	163	199	230	1.58	1.58					
	THF28020	79°	80°	80°	44.3	76.7	99.0	117	140	171	198	242	280	1.81	1.75					
	THF32020	83°	85°	85°	50.6	87.6	113	134	160	196	226	277	320	2.02	1.75					
	THF34020	87°	90°	90°	53.8	93.1	120	142	170	208	240	294	340	2.09	1.75					
	THF43520	92°	95°	95°	68.8	119	154	182	218	266	308	377	435	2.44	1.75					
3	THF18524	58°	58°	58°	29.3	50.7	65.4	77.4	92.5	113	131	160	185	1.28	1.28	5.74	7.90	6.18	3.66	8.88
	THF23024	65°	65°	65°	36.4	63.0	81.3	96.2	115	141	163	199	230	1.44	1.44					
	THF28024	70°	70°	70°	44.3	76.7	99.0	117	140	171	198	242	280	1.63	1.63					
	THF32024	65°	70°	70°	50.6	87.6	113	134	160	196	226	277	320	1.78	1.78					
	THF34024	68°	70°	70°	53.8	93.1	120	142	170	208	240	294	340	1.84	1.84					
	THF41224	75°	78°	78°	65.1	113	146	172	206	252	291	357	412	2.11	2.11					
	THF46924	75°	80°	80°	74.2	128	166	196	235	287	332	406	469	2.28	2.13					
	THF52624	78°	80°	80°	83.2	144	186	220	263	322	372	456	526	2.48	2.13					
THF56424	78°	80°	80°	89.2	154	199	236	282	345	399	488	564	2.59	2.13						

Flow Rate (GPM) = $K\sqrt{PSI}$

Standard Materials: Brass, Carbon Steel and 316 Stainless Steel.

Spray angle performance varies with pressure. Contact BETE for specific data on critical applications.

CALL 413-772-0846
Call for the name of your nearest BETE representative.

THIW



Metal

HOLLOW CONE

Tangential Inlet/Wide Spray Band

DESIGN FEATURES

- Large free passage
- Clog-resistant; nozzles have no internal parts
- Wide spray band
- Female connection
- Flanged connection available
- Patented design
- Silicon carbide available upon request
- Inlet and outlet are in-line

SPRAY CHARACTERISTICS

- Spray pattern:** Hollow Cone
- Spray angle:** Wide
- Flow rates:** 4.11 to 564 gpm

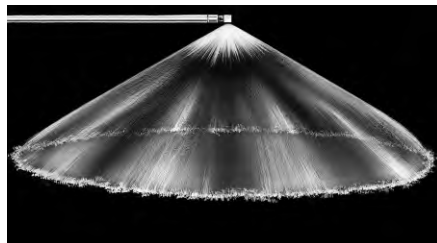

Hollow Cone - Wide Angle

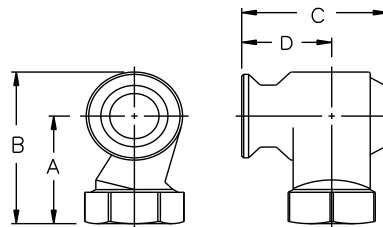

Dimensions are approximate. Check with BETE for critical dimension applications.

THW Flow Rates and Dimensions

Hollow Cone, Wide Spray Angles, 1" to 3" Pipe Sizes

Female Pipe Size	Nozzle Number	Spray Ang. 5° 15° 40° PSI PSI PSI	K Factor	GALLONS PER MINUTE @ PSI								Approx. Orifice Dia. (in.)	Free Pass. Dia. (in.)	Dimensions (in.) (MAX)				Wt. (lbs.)
				3 PSI	5 PSI	7 PSI	10 PSI	15 PSI	20 PSI	30 PSI	40 PSI			A	B	C	D	
1	THFW1508	100° 100° 100°	2.37	4.11	5.30	6.27	7.50	9.19	10.6	13.0	15.0	0.34	0.34	2.31	3.13	2.33	1.40	1.40
	THFW1808	115° 115° 115°	2.85	4.93	6.36	7.53	9.00	11.0	12.7	15.6	18.0	0.38	0.38					
	THFW2308	120° 120° 120°	3.64	6.30	8.13	9.62	11.5	14.1	16.3	19.9	23.0	0.44	0.44					
	THFW2708		4.27	7.39	9.55	11.3	13.5	16.5	19.1	23.4	27.0	0.47	0.47					
	THFW3208		5.06	8.76	11.3	13.4	16.05	19.6	22.6	27.7	32.0	0.44	0.44					
	THFW3808		6.01	10.4	13.4	15.9	19.0	23.3	26.9	32.9	38.0	0.60	0.60					
1 1/4	THFW3210	120° 120° 120°	5.06	8.76	11.3	13.4	16.0	19.6	22.6	27.7	32.0	0.55	0.55	2.81	3.79	2.86	1.74	1.65
	THFW3810		6.01	10.4	13.4	15.9	19.0	23.3	26.9	32.9	38.0	0.63	0.63					
	THFW4110		6.48	11.2	14.5	17.2	20.5	25.1	29.0	35.5	41.0	0.66	0.66					
	THFW5210		8.22	14.2	18.4	21.8	26.0	31.8	36.8	45.0	52.0	0.78	0.78					
	THFW7010		11.1	19.2	24.7	29.3	35.0	42.9	49.5	60.6	70.0	1.03	0.89					
1 1/2	THFW6112	110° 110° 110°	9.65	16.7	21.6	25.5	30.5	37.4	43.1	52.8	61.0	0.77	0.77	2.98	4.14	3.62	2.27	1.94
	THFW7012	112° 115° 115°	11.1	19.2	24.7	29.3	35.0	42.9	49.5	60.6	70.0	0.84	0.84					
	THFW7712	117° 120° 120°	12.2	21.1	27.2	32.2	38.5	47.2	54.4	66.7	77.0	0.92	0.92					
	THFW9012		14.2	24.6	31.8	37.6	45.0	55.1	63.6	77.9	90.0	1.03	1.03					
	THFW12712		20.1	34.8	44.9	53.1	63.5	77.8	89.8	110	127	1.30	1.06					
	THFW14512		22.9	39.7	51.3	60.7	72.5	88.8	103	126	145	1.42	1.06					

$$\text{Flow Rate (GPM)} = K \sqrt{\text{PSI}}$$

Standard Materials: Brass, Carbon Steel and 316 Stainless Steel.

Spray angle performance varies with pressure. Contact BETE for specific data on critical applications.

TO ORDER: specify pipe size, connection type, nozzle number, spray angle, and material.



HOLLOW CONE



Silicon Carbide, Flanged

Dimensions are approximate. Check with BETE for critical dimension applications.

THW Flow Rates and Dimensions
Hollow Cone, Wide Spray Angles, 1" to 3" Pipe Sizes

Female Pipe Size	Nozzle Number	Spray Ang.			K Factor	GALLONS PER MINUTE @ PSI								Approx. Orifice Dia. (in.)	Free Pass. Dia. (in.)	Dimensions (in.) (MAX)				Wt. (lbs.)
		5 PSI	15 PSI	40 PSI		3 PSI	5 PSI	7 PSI	10 PSI	15 PSI	20 PSI	30 PSI	40 PSI			A	B	C	D	
2	THFW8516	112°	115°	115°	13.4	23.3	30.1	35.6	42.5	52.1	60.1	73.6	85.0	0.86	0.86	3.63	5.12	4.46	2.72	3.25
	THFW10516	120°	120°	120°	16.6	28.8	37.1	43.9	52.5	64.3	74.2	90.9	105	1.00	1.00					
	THFW12516	119°	120°	120°	19.8	34.2	44.2	52.3	62.5	76.5	88.4	108	125	1.14	1.14					
	THFW14516				22.9	39.7	51.3	60.7	72.5	88.8	103	126	145	1.27	1.27					
	THFW17016				26.9	46.6	60.1	71.1	85.0	104	120	147	170	1.39	1.39					
	THFW19216	120°	120°	120°	30.4	52.6	67.9	80.3	96.0	118	136	166	192	1.52	1.44					
	THFW20516				32.4	56.1	72.5	85.8	103	126	145	178	205	1.63	1.44					
	THFW23016				36.4	63.0	81.3	96.2	115	141	163	199	230	1.75	1.44					
2 1/2	THFW17020	117°	120°	120°	26.9	46.6	60.1	71.1	85.0	104	120	147	170	1.33	1.33	4.93	6.82	5.97	3.81	7.06
	THFW19020				30.0	52.0	67.2	79.5	95.0	116	134	165	190	1.42	1.42					
	THFW20520				32.4	56.1	72.5	85.8	103	126	145	178	205	1.47	1.47					
	THFW23020				36.4	63.0	81.3	96.2	115	141	163	199	230	1.58	1.58					
	THFW28020	120°	120°	120°	44.3	76.7	99.0	117	140	171	198	242	280	1.81	1.75					
	THFW32020				50.6	87.6	113	134	160	196	226	277	320	2.02	1.75					
	THFW34020				53.8	93.1	120	142	170	208	240	294	340	2.09	1.75					
	THFW43520				68.8	119	154	182	218	266	308	377	435	2.44	1.75					
3	THFW18524	120°	120°	120°	29.3	50.7	65.4	77.4	92.5	113	131	160	185	1.28	1.28	5.77	7.98	6.88	4.32	9.47
	THFW23024				36.4	63.0	81.3	96.2	115	141	163	199	230	1.44	1.44					
	THFW28024				44.3	76.7	99.0	117	140	171	198	242	280	1.63	1.63					
	THFW32024				50.6	87.6	113	134	160	196	226	277	320	1.78	1.78					
	THFW34024				53.8	93.1	120	142	170	208	240	294	340	1.84	1.84					
	THFW41224				65.1	113	146	172	206	252	291	357	412	2.11	2.11					
	THFW46924				74.2	128	166	196	235	287	332	406	469	2.28	2.13					
	THFW52624				83.2	144	186	220	263	322	372	456	526	2.48	2.13					
	THFW56424				89.2	154	199	236	282	345	399	488	564	2.59	2.13					

Flow Rate (GPM) = K √PSI

Standard Materials: Brass, Carbon Steel and 316 Stainless Steel.

Spray angle performance varies with pressure. Contact BETE for specific data on critical applications.

CALL 413-772-0846
 Call for the name of your nearest BETE representative.

BJ

Low Flow

DESIGN FEATURES

- Three-piece construction
- Interchangeable spray tips
- Integral strainer available (refer to page 121 for more information)
- Male and female connections

SPRAY CHARACTERISTICS

- Relatively coarse atomization
- Uniform distribution with tapered edges for use in overlapping sprays

Spray pattern: Flat Fan

Spray angles: 0° to 110°

Flow rate: 0.024 to 24.7 gpm



Metal



FAN

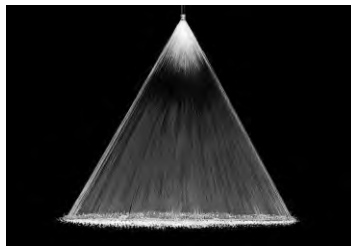

Fan 50°

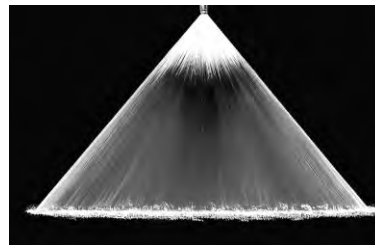

Fan 80°

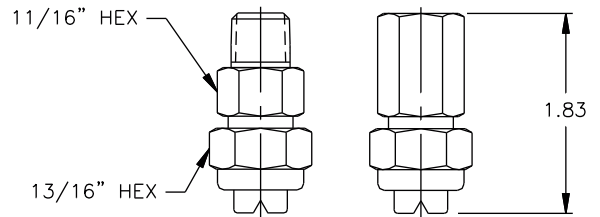

Dimensions are approximate. Check with BETE for critical dimension applications.

BJ Spray Angles and Weights

Fan, 0° to 110° Spray Angles, 1/8", 1/4", 3/8", and 1/2" Pipe Size, Male and Female

Pipe Size	Nozzle Number	Flow Rate @ 40 psi	Available Spray Angle										Optional Strainer Mesh Size	Wt. (Oz.)	
			0°	15°	25°	40°	50°	65°	73°	80°	95°	110°			
1/8"	BJ 0067	0.067	0°	15°	25°	40°	50°	65°						100	2
	BJ 0077	0.077							73°						
	BJ 01	0.10	0°	15°	25°	40°	50°	65°		80°	95°	110°			
	BJ 0116	0.12							73°						
OR	BJ 015	0.15	0°	15°	25°	40°	50°	65°		80°	95°	110°	50	2	
	BJ 0154	0.15							73°						
	BJ 02	0.20	0°	15°	25°	40°	50°	65°		80°	95°	110°			
	BJ 0231	0.23							73°						
1/4"	BJ 03	0.30	0°	15°	25°	40°	50°	65°		80°	95°	110°	50	2	
	BJ 0308	0.31							73°						
	BJ 0385	0.39	0°	15°	25°	40°	50°	65°		80°	95°	110°			
	BJ 04	0.40	0°	15°	25°	40°	50°	65°		80°	95°	110°			
OR	BJ 0462	0.46							73°						
	BJ 05	0.50	0°	15°	25°	40°	50°	65°		80°	95°	110°	50	2	
	BJ 06	0.60	0°	15°	25°	40°	50°	65°		80°	95°	110°			
	BJ 0616	0.62							73°						
BJ 077	0.77							73°							
OR	BJ 08	0.80	0°	15°	25°	40°	50°	65°		80°	95°	110°	50	2	
	BJ 0924	0.92							73°						
	BJ 10	1.0	0°	15°	25°	40°	50°	65°		80°	95°	110°			
	BJ 15	1.5	0°	15°	25°	40°	50°	65°		80°	95°	110°			
1/2"	BJ 20	2.0	0°	15°	25°	40°	50°	65°		80°	95°	110°	50	2	
	BJ 30	3.0	0°	15°	25°	40°	50°	65°		80°	95°	110°			
	BJ 40	4.0	0°	15°	25°	40°	50°	65°		80°	95°	110°			
	BJ 50	5.0							80°	95°	110°				
OR	BJ 60	6.0		15°	25°	40°	50°	65°		80°	95°	110°	50	2	
	BJ 70	7.0		15°	25°	40°	50°	65°		80°	95°	110°			
	BJ 40	4.0	0°	15°	25°	40°	50°	65°		80°	95°	110°			
	BJ 50	5.0							80°	95°	110°				
1/2"	BJ 60	6.0		15°	25°	40°	50°	65°		80°	95°	110°	50	2	
	BJ 70	7.0		15°	25°	40°	50°	65°		80°	95°	110°			
	BJ 40	4.0	0°	15°	25°	40°	50°	65°		80°	95°	110°			
	BJ 50	5.0							80°	95°	110°				

Spray angle performance varies with pressure. Contact BETE for specific data on critical applications.

TO ORDER: specify pipe size, connection type, nozzle number, spray angle, and material.

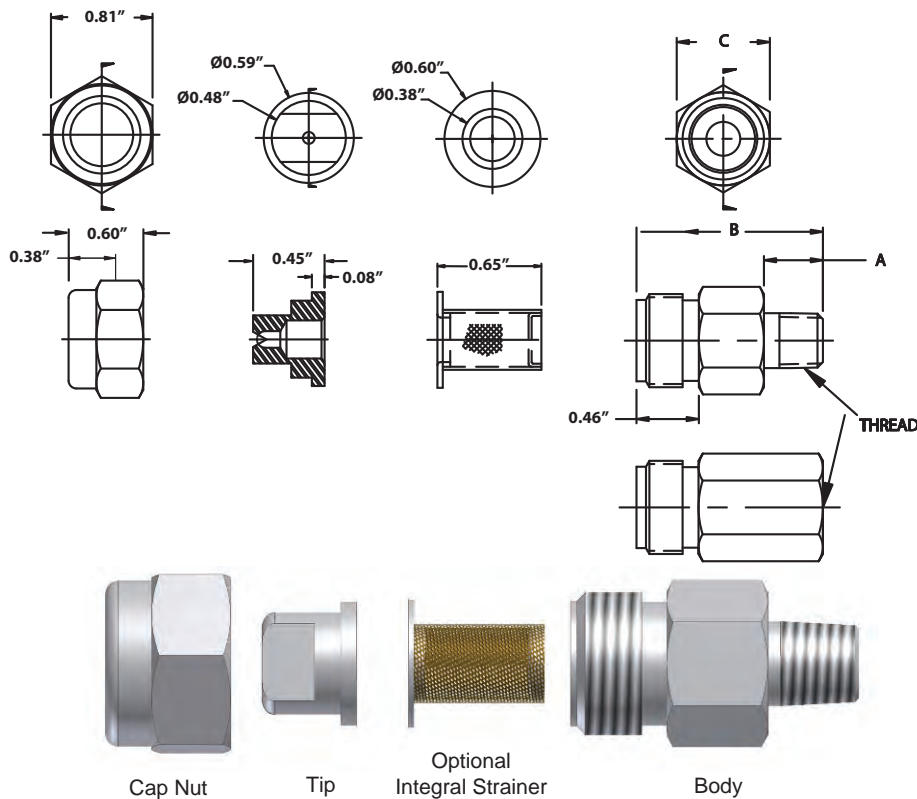

THREAD	A	B	C
1/8" MALE	0.44"	1.38"	11/16"
1/8" FEM	N/A	1.38"	11/16"
1/4" MALE	0.56"	1.38"	11/16"
1/4" FEM	N/A	1.38"	11/16"
3/8" MALE	0.56"	1.38"	11/16"
3/8" FEM	N/A	1.38"	13/16"
1/2" MALE	0.62"	1.38"	7/8"
1/2" FEM	N/A	1.38"	1 1/8"

Dimensions are approximate. Check with BETE for critical dimension applications.

BJ Flow Rates

Fan, 0°, 15°, 25°, 40°, 50°, 65°, 73°, 80°, 95°, 110° Spray Angles, 1/8", 1/4" and 3/8" Pipe Size, Male and Female

Pipe Size	Nozzle Number	Equiv. Orifice Dia. (in.)	K Factor	GALLONS PER MINUTE @ PSI									
				5 PSI	10 PSI	20 PSI	40 PSI	60 PSI	80 PSI	100 PSI	200 PSI	300 PSI	500 PSI
1/8	BJ 0067	0.023	0.0106	0.024	0.034	0.047	0.067	0.082	0.095	0.11	0.15	0.18	0.24
	BJ 0077	0.023	0.0122	0.027	0.039	0.054	0.077	0.094	0.11	0.12	0.17	0.21	0.27
	BJ 01	0.028	0.0158	0.035	0.050	0.071	0.10	0.12	0.14	0.16	0.22	0.27	0.35
	BJ 0116	0.028	0.0183	0.041	0.058	0.082	0.12	0.14	0.16	0.18	0.26	0.32	0.41
OR	BJ 015	0.033	0.0237	0.053	0.075	0.11	0.15	0.18	0.21	0.24	0.34	0.41	0.53
	BJ 0154	0.033	0.0243	0.054	0.077	0.11	0.15	0.19	0.22	0.24	0.34	0.42	0.54
1/4	BJ 02	0.039	0.0316	0.071	0.10	0.14	0.20	0.24	0.28	0.32	0.45	0.55	0.71
	BJ 0231	0.040	0.0365	0.082	0.12	0.16	0.23	0.28	0.33	0.37	0.52	0.63	0.82
	BJ 03	0.047	0.0474	0.11	0.15	0.21	0.30	0.37	0.42	0.47	0.67	0.82	1.1
OR	BJ 0308	0.047	0.0487	0.11	0.15	0.22	0.31	0.38	0.44	0.49	0.69	0.84	1.1
	BJ 0385	0.051	0.0609	0.14	0.19	0.27	0.39	0.47	0.54	0.61	0.86	1.1	1.4
3/8	BJ 04	0.055	0.0632	0.14	0.20	0.28	0.40	0.49	0.57	0.63	0.89	1.1	1.4
	BJ 0462	0.056	0.0730	0.16	0.23	0.33	0.46	0.57	0.65	0.73	1.0	1.3	1.6
	BJ 05	0.061	0.0791	0.18	0.25	0.35	0.50	0.61	0.71	0.79	1.1	1.4	1.8
	BJ 06	0.067	0.0949	0.21	0.30	0.42	0.60	0.73	0.85	0.95	1.3	1.6	2.1
OR	BJ 0616	0.067	0.0974	0.22	0.31	0.44	0.62	0.75	0.87	0.97	1.4	1.7	2.2
	BJ 077	0.072	0.122	0.27	0.39	0.54	0.77	0.94	1.09	1.2	1.7	2.1	2.7
	BJ 08	0.074	0.127	0.28	0.40	0.57	0.80	0.98	1.1	1.3	1.8	2.2	2.8
	BJ 0924	0.076	0.148	0.33	0.46	0.65	0.92	1.1	1.3	1.5	2.1	2.5	3.3
1/2"	BJ 10	0.086	0.158	0.35	0.5	0.71	1.0	1.2	1.4	1.6	2.2	2.7	3.5
	BJ 15	0.107	0.237	0.53	0.75	1.1	1.5	1.8	2.1	2.4	3.4	4.1	5.3
	BJ 20	0.125	0.316	0.71	1.0	1.4	2.0	2.4	2.8	3.2	4.5	5.5	7.1
3/8	BJ 30	0.141	0.474	1.1	1.5	2.1	3.0	3.7	4.2	4.7	6.7	8.2	10.6
	BJ 40	0.156	0.633	1.4	2.0	2.8	4.0	4.9	5.7	6.3	8.9	11.0	14.1
	BJ 50	0.172	0.791	1.8	2.5	3.5	5.0	6.1	7.1	7.9	11.2	13.7	17.7
	BJ 60	0.188	0.949	2.1	3.0	4.2	6.0	7.3	8.5	9.5	13.4	16.4	21.2
OR	BJ 70	0.203	1.107	2.5	3.5	4.9	7.0	8.6	9.9	11.1	15.7	19.2	24.7

$$\text{Flow Rate (GPM)} = K \sqrt{\text{PSI}}$$

Standard Materials: Brass, 303 Stainless Steel, and 316 Stainless Steel (for nozzle number BJ01 and higher).

Spray angle performance varies with pressure. Contact BETE for specific data on critical applications.

HydroPulse®

Pneumatically Actuated - Low Flow Flat Fan

DESIGN FEATURES

- Interchangeable flat fan spray tips
- Pneumatically actuated for crisp on/off spray
- Straight through porting for in-series set-up
- Variety of mounting brackets available

SPRAY CHARACTERISTICS

- Relatively coarse atomization
 - Uniform distribution with tapered edges for use in overlapping sprays
- Spray pattern:** Flat Fan
Spray angles: 0° to 110°
Flow rate: 0.024 to 24.7 gpm

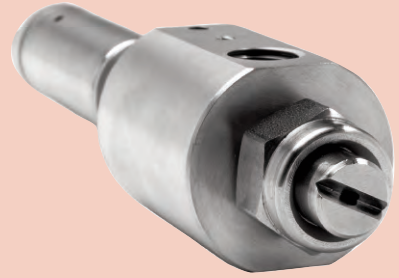

HP01 Assembly

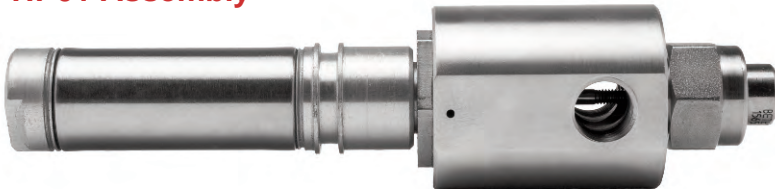

HP02 Assembly



Easy to maintain; positive sealing performance!

- **Fluid Connection Size:** 1/8", 1/4", Female, NPT/BSP

Two fluid ports are standard, allowing for an in-series setup; a plug to seal one port is included.

- **Maximum Fluid Pressure:** 600 psi
- **Air Cylinders:** Single-acting spring extend type. Air pressure retracts the rod and allows flow through the nozzle. Removing air pressure extends the rod and seals the nozzle. Double-acting cylinder available upon request.
- **Air Connection Size:** 1/8" Female NPT; 1/8" Female BSP Adapter automatically included when fluid connection is BSP
- **Air Cylinder Pressure:** Minimum: 30 psi*; Maximum: 250 psi.
*For larger BJ tips, more pressure may be required to break seal.
- **Frequency Rating:** Up to 180 cycles/minute, with an appropriate solenoid valve (Cv=0.08 minimum).
- **Weights:** HP01 Assembly: 1.3 lbs; HP02 Assembly: 1.5 lbs
- **Operating Temperature Range:** -15 °F to 400 °F. Nylon Mounting Hardware: 250 °F MAX
- **Standard Materials:**

Body: Nickel-plated Brass or 303 Stainless Steel

Internals: PTFE, Viton, 303SS

Air Cylinder: Stainless Steel, Anodized Aluminum, PTFE, and Viton®

Fluid Seals: FDA-compliant Viton®

TO ORDER: specify pipe size, connection type, nozzle number, spray angle, and material.

HydroPulse® Components & Options

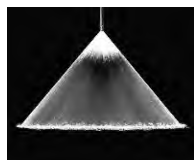

Fan 80°

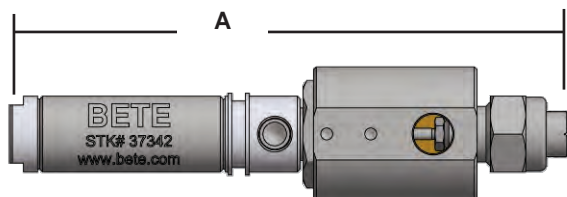

A - Overall Length (inches)	
HP01	HP02
6	7.59

Flat Fan (BJ) Tip - Flow Rates, Dimensions, and Angles

Nozzle Tip Number	K Factor	GALLONS PER MINUTE @ PSI								Equivalent Orifice Dia. (in.)	Available Spray Angles
		5 PSI	10 PSI	20 PSI	40 PSI	80 PSI	100 PSI	500 PSI			
BJ 0067	0.0106	0.024	0.034	0.047	0.067	0.095	0.11	0.24	0.023	0, 15, 25, 40, 50, 65, 80	
BJ 0077	0.0122	0.027	0.039	0.054	0.077	0.11	0.12	0.27	0.023	73	
BJ 01	0.0158	0.035	0.050	0.071	0.100	0.14	0.16	0.35	0.028	0, 15, 25, 40, 50, 65, 80, 95, 110	
BJ 0116	0.0183	0.041	0.058	0.082	0.116	0.164	0.183	0.41	0.036	73	
BJ 015	0.0237	0.053	0.075	0.11	0.15	0.21	0.24	0.53	0.038	0, 15, 25, 40, 50, 65, 80, 95, 110	
BJ 02	0.0316	0.071	0.10	0.14	0.20	0.28	0.32	0.71	0.039	0, 15, 25, 40, 50, 65, 80, 95, 110	
BJ 03	0.0474	0.11	0.15	0.21	0.30	0.42	0.47	1.1	0.047	0, 15, 25, 40, 50, 65, 80, 95, 110	
BJ 04	0.0632	0.14	0.20	0.28	0.40	0.57	0.63	1.4	0.055	0, 15, 25, 40, 50, 65, 80, 95, 110	
BJ 05	0.0791	0.18	0.25	0.35	0.50	0.71	0.79	1.8	0.061	0, 15, 25, 40, 50, 65, 80, 95, 110	
BJ 06	0.0949	0.21	0.30	0.42	0.60	0.85	0.95	2.1	0.067	0, 15, 25, 40, 50, 65, 80, 95, 110	
BJ 08	0.127	0.28	0.40	0.57	0.80	1.1	1.3	2.8	0.074	0, 15, 25, 40, 50, 65, 80, 95, 110	
BJ 10	0.158	0.35	0.50	0.71	1.0	1.4	1.6	3.5	0.086	0, 15, 25, 40, 50, 65, 80, 95, 110	
BJ 15	0.237	0.53	0.75	1.1	1.5	2.1	2.4	5.3	0.107	0, 15, 25, 40, 50, 65, 80, 95, 110	
BJ 20*	0.316	0.71	1.0	1.4	2.0	2.8	3.2	7.1	0.125	0, 15, 25, 40, 50, 65, 80, 95, 110	
BJ 30*	0.474	1.1	1.5	2.1	3.0	4.2	4.7	10.6	0.141	0, 15, 25, 40, 50, 65, 80, 95, 110	
BJ 40*	0.633	1.4	2.0	2.8	4.0	5.7	6.3	14.1	0.156	0, 15, 25, 40, 50, 65, 80, 95, 110	
BJ 50*	0.791	1.8	2.5	3.5	5.0	7.1	7.9	17.7	0.172	15, 25, 40, 50, 65, 80, 95, 110	
BJ 60*	0.949	2.1	3.0	4.2	6.0	8.5	9.5	21.2	0.188	15, 25, 40, 50, 65, 80, 95, 110	
BJ 70*	1.107	2.5	3.5	4.9	7.0	9.9	11.1	24.7	0.203	15, 25, 40, 50, 65, 80, 95, 110	

*HP 02 ONLY

$$\text{Flow Rate (GPM)} = K\sqrt{\text{PSI}}$$

BJ Tip Materials: Brass, 303 Stainless Steel, and 316 Stainless Steel.

Spray angle performance varies with pressure. Contact BETE for specific data on critical applications.



FAN

CALL 413-772-0846
Call for the name of your nearest BETE representative.

HydroPulse

Optional Mounting Bracket Kits

Kit 01
Angle Bracket

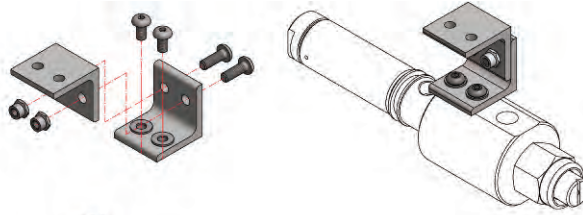

Kit 02
V-Block Bracket

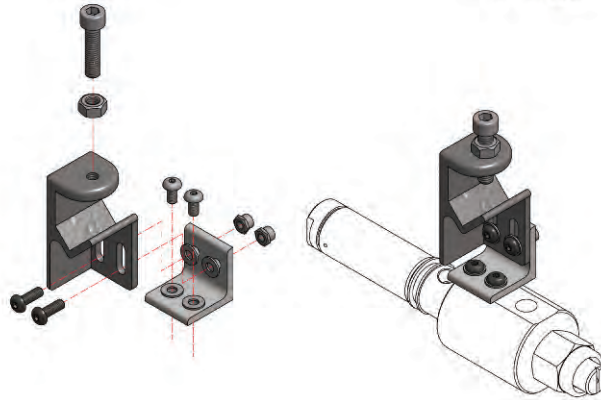

Kit 03
Clamp Bracket

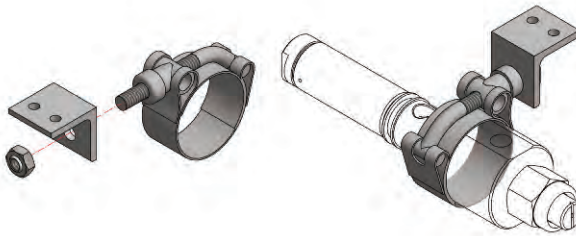

Kit 04
Direct Mount
V-Block Bracket

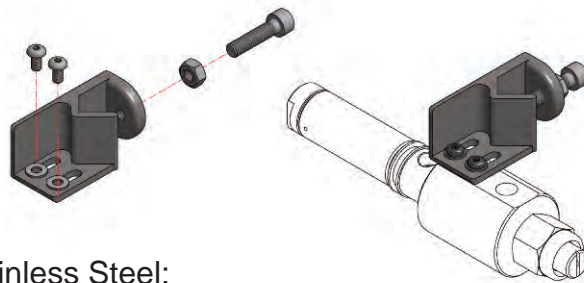

Brackets: 316 Stainless Steel;
Hardware: 18-8SS with Nylon locking insert

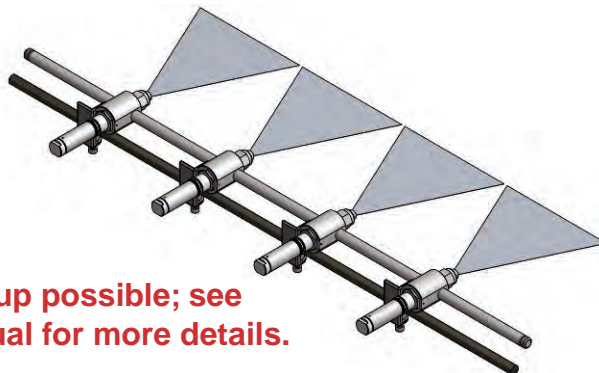

In-series set-up possible; see instruction manual for more details.

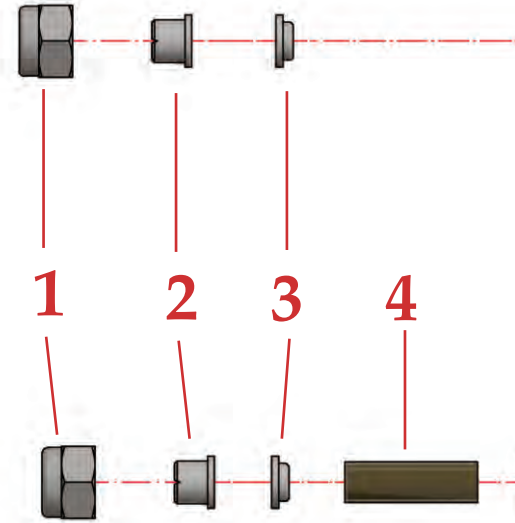

Item Number	Part Name
1	CAP NUT
2	TIP (BJ, BJH, CW, ST)
3	SEALING WASHER
4	FLOW CONDITIONER (HP 02 ONLY)
5	HEX SOCKET PLUG
6	BODY
7	SEALING TIP
8	JAM NUT
9	BUSHING O-RING
10	BUSHING
11	AIR CYLINDER O-RING (x2)
12	BACK-UP RING
13	COMPRESSIBLE BUSHING
14	AIR CYLINDER

TO ORDER: specify pipe size, connection type, nozzle number, spray angle, and material.

HydroPulse® Components & Options

HydroPulse 01

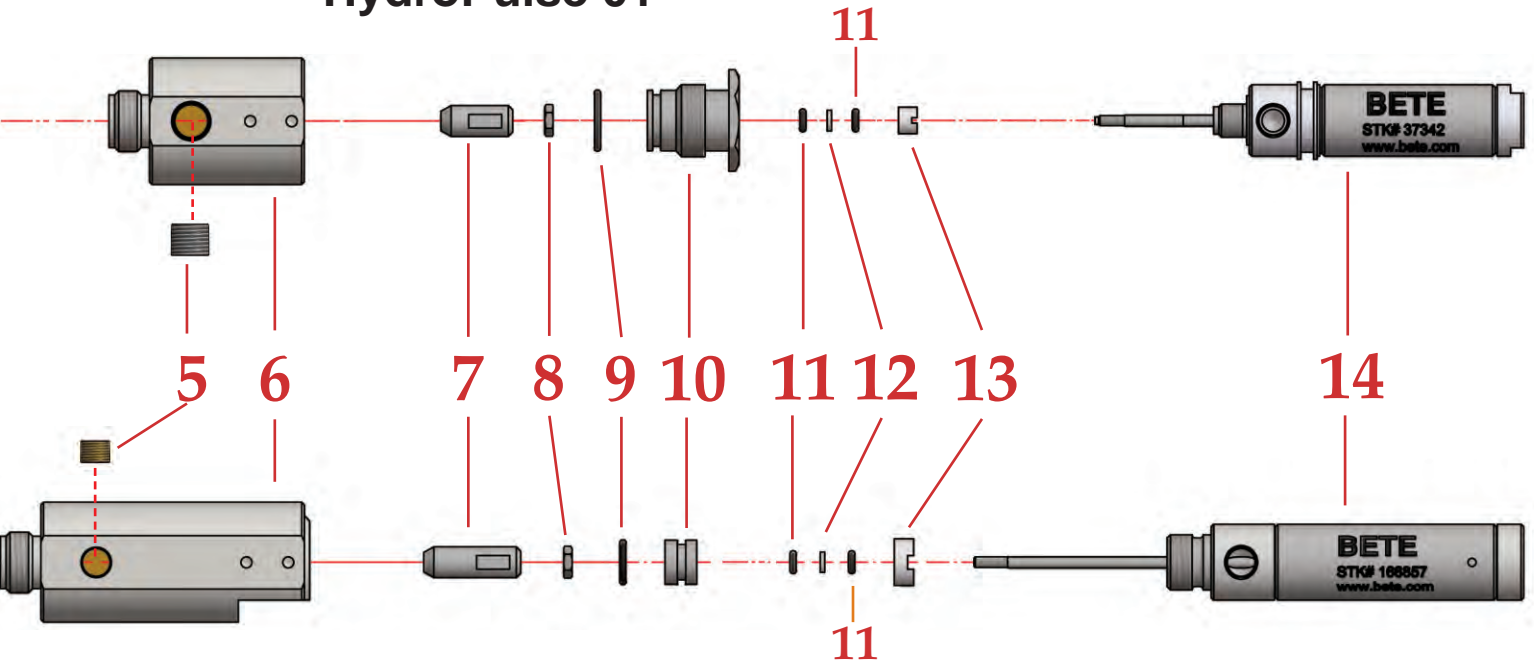

HydroPulse 02

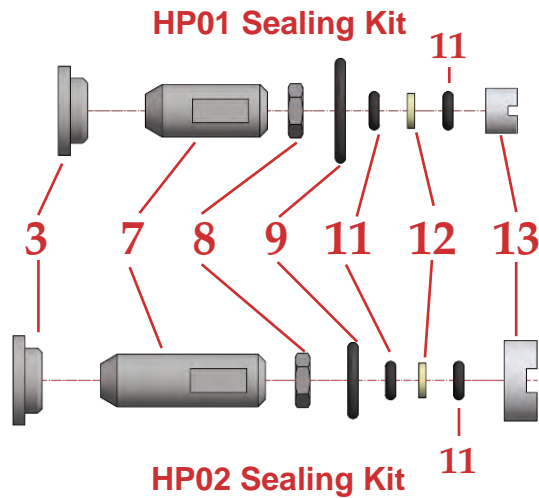

TO ORDER

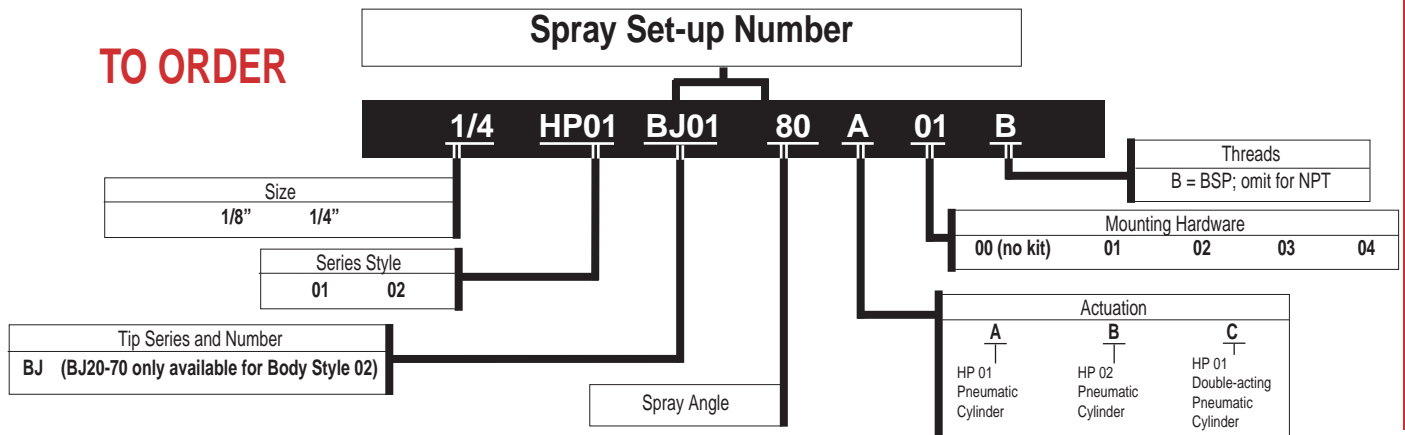

CALL 413-772-0846
Call for the name of your nearest BETE representative.

NFV

Fan Nozzle with Integral Strainer Option

DESIGN FEATURES

- One-piece construction
- No internal parts
- Male connection
- Low nozzle maintenance
- Optional removable strainer for easy cleaning

Connections: Male NPT and BSP

Optional Strainer: 50, 100, 200 mesh

SPRAY CHARACTERISTICS

- High impact
 - Uniform distribution
- Spray pattern:** Flat Fan and Straight Jet
Spray angles: 0°, 15°, 25°, 40°, 50°, 65°, 80°, 95°, 110°
NFV0067: Max. spray angle available 95°
Flow rates: 0.041 to 12.6 gpm

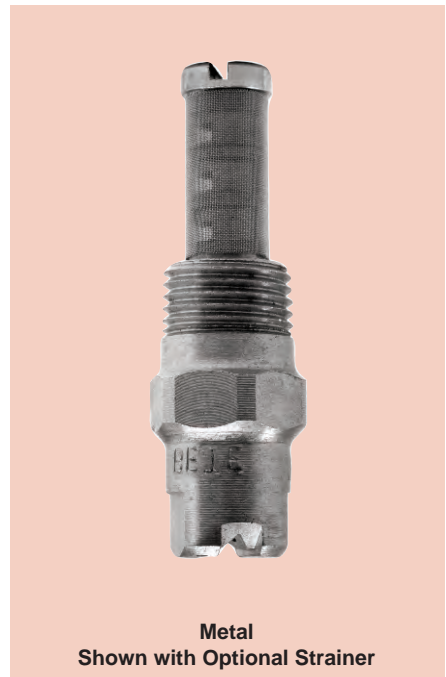

Metal
Shown with Optional Strainer

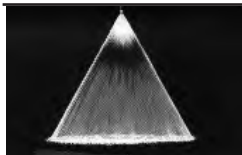

Fan 50°

Call BETE to verify spray angle performance at operating pressures above 70 psi.

To Order: Spray Set-up Number

1/4 NFV 0067 95 -L -B 303

pipe size | series | nozzle number | spray angle | optional strainer, also specify mesh size | specify material | BSP thread

NFV Dimensions

Pipe Size	Dimensions (in.)			Wt. (oz.)
	A	B	C	
1/8	0.88	0.44	1.49	1.00
1/4	1.06	0.56	1.69	1.50

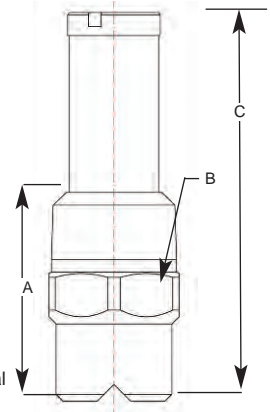

NFV Flow Rates

Fan and Straight Jet, 0°, 15°, 25°, 40°, 50°, 65°, 80°, 95° (all sizes); 110° (NFV01 and higher)

Male Pipe Size	Nozzle Number	K Factor	GALLONS PER MINUTE @ PSI										Equiv. Orifice Dia. (in.)	Screen Mesh Selection Guide
			15 PSI	20 PSI	30 PSI	40 PSI	60 PSI	80 PSI	100 PSI	150 PSI	200 PSI	400 PSI		
1/8" or 1/4"	NFV0067**	0.0106	0.041	0.047	0.057	0.067	0.082	0.095	0.110	0.130	0.150	0.210	0.023	100
	NFV01	0.0158	0.06	0.07	0.09	0.10	0.12	0.14	0.16	0.19	0.22	0.32	0.026	100
	NFV015	0.0237	0.09	0.11	0.13	0.15	0.18	0.21	0.24	0.29	0.34	0.47	0.031	100
	NFV02	0.0316	0.12	0.14	0.17	0.20	0.25	0.28	0.32	0.39	0.45	0.63	0.036	100
	NFV025	0.0395	0.15	0.18	0.22	0.25	0.31	0.35	0.40	0.48	0.56	0.79	0.040	50
	NFV03	0.0474	0.18	0.21	0.26	0.30	0.37	0.42	0.47	0.58	0.67	0.95	0.043	50
	NFV04	0.0632	0.25	0.28	0.35	0.40	0.49	0.57	0.63	0.78	0.89	1.25	0.052	50
	NFV05	0.0791	0.31	0.35	0.43	0.50	0.61	0.71	0.79	0.97	1.12	1.58	0.057	50
	NFV06	0.0949	0.37	0.42	0.52	0.60	0.74	0.85	0.95	1.16	1.34	1.90	0.062	50
	NFV07	0.111	0.43	0.50	0.61	0.70	0.86	0.99	1.11	1.36	1.57	2.22	0.082	50
	NFV08	0.126	0.49	0.57	0.69	0.80	0.98	1.13	1.26	1.55	1.79	2.53	0.072	50
	NFV10	0.158	0.61	0.71	0.87	1.00	1.22	1.41	1.58	1.94	2.24	3.16	0.080	50
	NFV15	0.237	0.92	1.06	1.30	1.50	1.84	2.12	2.37	2.90	3.35	4.74	0.094	50
	NFV20	0.316	1.22	1.41	1.73	2.00	2.45	2.83	3.16	3.87	4.47	6.32	0.109	50
	NFV30	0.474	1.84	2.12	2.60	3.00	3.67	4.24	4.74	5.81	6.71	9.49	0.141	50
	NFV40	0.632	2.45	2.45	3.46	4.00	4.90	5.66	6.32	7.75	8.94	12.60	0.156	50

**NFV0067: Max. spray angle available: 95°

Flow Rate (GPM) = $K \sqrt{\text{PSI}}$ Standard Materials: Brass and 303 Stainless Steel. Highlighted NFVs available in 316 Stainless Steel.

Spray angle performance varies with pressure. Contact BETE for specific data on critical applications.

TO ORDER: specify pipe size, connection type, nozzle number, spray angle, and material.

NF

Standard Fan Nozzle

DESIGN FEATURES

- One-piece construction
- No internal parts
- Sizes for all applications
- Male connection

SPRAY CHARACTERISTICS

- High impact
- Uniform distribution with tapered edges for overlapping sprays
- Extra-wide angles available

Spray pattern: Fan and Straight Jet

Spray angles: 0° to 120°

Flow rates: 0.103 to 1380 gpm

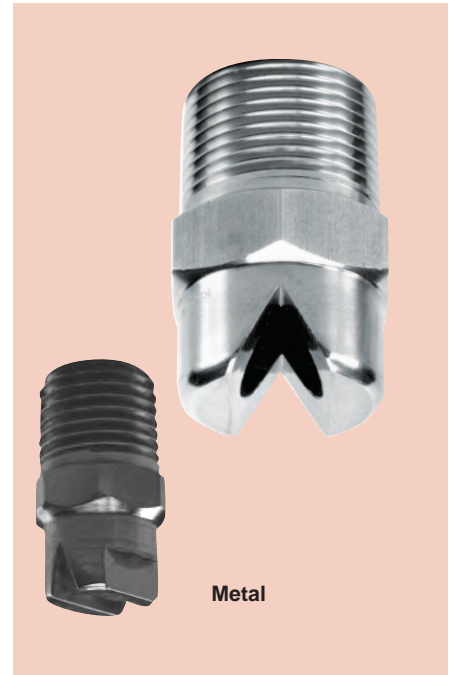

Metal

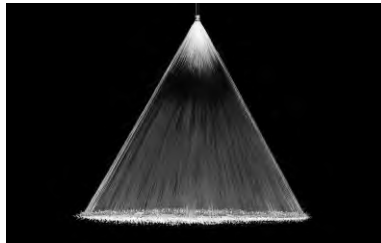

Fan 50°

Call BETE to verify spray angle performance at operating pressures above 70 psi.

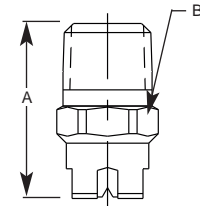

3/8" - 2" Metal

Dimensions are approximate. Check with BETE for critical dimension applications.

NF Flow Rates

Straight Jet: 0°; and Fan: 15°, 30°, 50°, 65°, 80°, 90°, 110°, and 120° Spray Angles, 1/8" to 2" Pipe Sizes

Male Pipe Size	Nozzle Number	K Factor	GALLONS PER MINUTE @ PSI												Equiv. Orifice Dia. (in.)
			5 PSI	10 PSI	15 PSI	20 PSI	30 PSI	40 PSI	60 PSI	80 PSI	100 PSI	150 PSI	200 PSI	400 PSI	
1/8 or 1/4	NF01	0.0158	0.03	0.05	0.06	0.07	0.09	0.10	0.12	0.14	0.16	0.19	0.22	0.32	0.026
	NF015	0.0237	0.05	0.08	0.09	0.11	0.13	0.15	0.18	0.21	0.24	0.29	0.34	0.47	
	NF02	0.0316	0.07	0.10	0.12	0.14	0.17	0.20	0.25	0.28	0.32	0.39	0.45	0.63	
	NF025	0.0395	0.09	0.13	0.15	0.18	0.22	0.25	0.31	0.35	0.40	0.48	0.56	0.79	
	NF03	0.0474	0.11	0.15	0.18	0.21	0.26	0.30	0.37	0.42	0.47	0.58	0.67	0.95	
	NF04	0.0632	0.14	0.20	0.25	0.28	0.35	0.40	0.49	0.57	0.63	0.78	0.89	1.25	
	NF05	0.0791	0.18	0.25	0.31	0.35	0.43	0.50	0.61	0.71	0.79	0.97	1.12	1.58	
	NF06	0.0949	0.21	0.30	0.37	0.42	0.52	0.60	0.74	0.85	0.95	1.16	1.34	1.90	
NF08	0.126	0.28	0.40	0.49	0.57	0.69	0.80	0.98	1.13	1.26	1.55	1.79	2.53	0.072	
1/8 or 1/4 or 3/8	NF10	0.158	0.35	0.50	0.61	0.71	0.87	1.00	1.22	1.41	1.58	1.94	2.24	3.16	0.080
	NF15	0.237	0.53	0.75	0.92	1.06	1.30	1.50	1.84	2.12	2.37	2.90	3.35	4.74	0.094
	NF20	0.316	0.71	1.00	1.22	1.41	1.73	2.00	2.45	2.83	3.16	3.87	4.47	6.32	0.109
	NF30	0.474	1.06	1.50	1.84	2.12	2.60	3.00	3.67	4.24	4.74	5.81	6.71	9.49	0.141
NF40	0.632	1.41	2.00	2.45	2.83	3.46	4.00	4.90	5.66	6.32	7.75	8.94	12.6	0.156	
1/4 or 3/8	NF50	0.791	1.77	2.50	3.06	3.54	4.33	5.00	6.12	7.07	7.91	9.68	11.2	15.8	0.172
	NF60	0.949	2.12	3.00	3.67	4.24	5.20	6.00	7.35	8.49	9.49	11.6	13.4	19.0	0.186
	NF70	1.11	2.47	3.50	4.29	4.95	6.06	7.00	8.57	9.90	11.1	13.6	15.6	22.1	0.203
	NF80	1.26	2.83	4.00	4.90	5.66	6.93	8.00	9.80	11.3	12.6	15.5	17.9	25.3	0.219
3/8 or 1/2	NF90	1.42	3.18	4.50	5.51	6.36	7.79	9.00	11.0	12.7	14.2	17.4	20.1	28.5	0.234
	NF100	1.58	3.54	5.00	6.12	7.07	8.66	10.0	12.2	14.1	15.8	19.4	22.4	31.6	0.250
	NF120	1.90	4.24	6.00	7.35	8.49	10.4	12.0	14.7	17.0	19.0	23.2	26.8	37.9	0.266
	NF150	2.37	5.30	7.50	9.19	10.6	13.0	15.0	18.4	21.2	23.7	29.0	33.5	47.4	0.297
NF200	3.16	7.07	10.0	12.2	14.1	17.3	20.0	24.5	28.3	31.6	38.7	44.7	63.2	0.344	
3/4	NF300	4.74	10.6	15.0	18.4	21.2	26.0	30.0	36.7	42.4	47.4	58.1	67.1	94.9	0.422
	NF400	6.32	14.1	20.0	24.5	28.3	34.6	40.0	49.0	56.6	63.2	77.5	89.4	126	0.500
1	NF400	6.32	14.1	20.0	24.5	28.3	34.6	40.0	49.0	56.6	63.2	77.5	89.4	126	0.500
	NF750	11.9	26.5	37.5	45.9	53.0	64.9	75.0	92.0	106	119	145	168	237	0.688
1 1/4	NF800	12.6	28.3	40.0	49.0	56.6	69.3	80.0	98.0	113	126	155	179	253	0.719
	NF1150	18.2	40.7	57.5	70.4	81.3	100	115	141	163	182	223	257	364	0.859
1 1/2	NF1500	23.7	53.0	75.0	91.9	106	130	150	184	212	237	290	335	474	0.969
2	NF2250	35.6	79.5	113	138	160	195	225	276	318	356	436	500	715	1.19

NF Dimensions

Pipe Size	Dim. for Metal Only (in.)		Wt. (oz.)	
	A	B	Metal	Plas.
1/8	0.88	0.44	1.00	0.25
1/4	1.06	0.56	1.50	0.38
3/8	1.25	0.69	2.00	0.50
1/2	1.50	0.88	3.00	1.00
3/4	1.75	1.13	6.00	1.50
1	2.19	1.38	8.00	2.00
1 1/4	2.50	1.75	12.0	3.00
1 1/2	3.00	2.00	20.0	5.00
2	3.50	2.50	56.0	10.0

Flow Rate (GPM) = $K \sqrt{PSI}$ Standard Materials: Brass, 303 Stainless Steel, 316 Stainless Steel, PVC and PTFE (PTFE not available in nozzle numbers NF025 and under).

Spray angle performance varies with pressure. Contact BETE for specific data on critical applications.



Call for the name of your nearest BETE representative.
CALL 413-772-0846

NFD

Dovetail Flat Fan

DESIGN FEATURES

- Dovetail joint guarantees alignment of interchangeable tips
- Dimensionally compatible with other dovetail systems
- Tips offset 5° or 15° for overlapping spray patterns
- Tapered overlapping spray provides uniform coverage
- Male, female and welded connections
- Other sizes available upon request

SPRAY CHARACTERISTICS

Spray pattern: Flat Fan
Spray angles: 20°, 30°, 45°, 60°, 90° and 120°. Special angles are available on request
Flow rates: 0.04 to 157 gpm



Metal

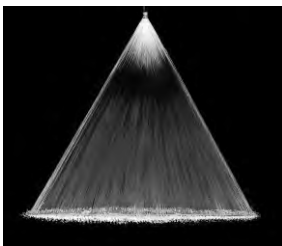

Fan 45°

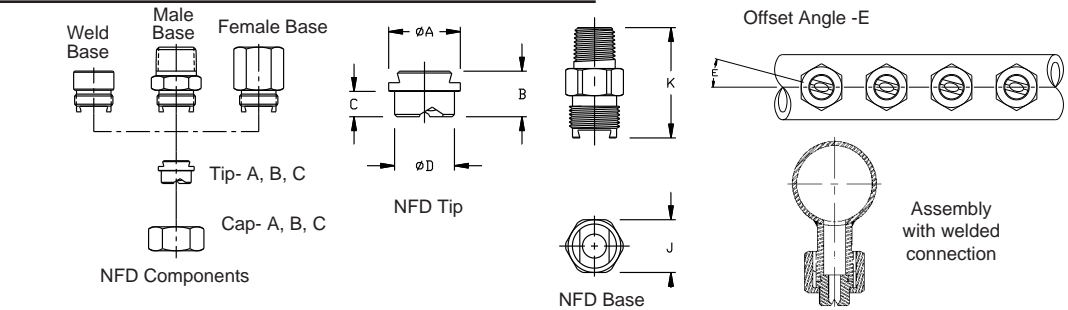

Dimensions are approximate. Check with BETE for critical dimension applications.

NFD Flow Rates and Dimensions

Fan, 20°, 30°, 45°, 60°, 90°, 120° Spray Angles, 1/4", 3/8", 1/2", 3/4" and 1-1/4" Pipe Size, or Welded Connections

Cap & Tip Size	Nozzle Number	Base Sizes* Available	K Factor	GALLONS PER MINUTE @ PSI								Equiv. Orifice Dia. (in.)	Approximate Tip Dimensions (in.)				Wt. (Oz.)	BSP NPT Pipe	Approx. Base Dim. (in.)		
				10 PSI	20 PSI	40 PSI	60 PSI	80 PSI	100 PSI	200 PSI	400 PSI		A	B	C	D			J	K	
A	NFD 010	1/4 3/8 1/2	0.016	0.049	0.070	0.10	0.12	0.14	0.16	0.22	0.31	0.028	0.58	5°	1.5	1/4"	0.69	1.44			
	NFD 014	1/4 3/8 1/2	0.022	0.070	0.10	0.14	0.17	0.20	0.22	0.31	0.44	0.035									
	NFD 019	1/4 3/8 1/2	0.031	0.10	0.14	0.19	0.24	0.28	0.31	0.44	0.62	0.039									
	NFD 031	1/4 3/8 1/2	0.049	0.15	0.22	0.31	0.38	0.44	0.49	0.69	0.98	0.047	0.47	15°	6.0	3/8"	0.69	1.44			
	NFD 039	1/4 3/8 1/2	0.061	0.19	0.27	0.39	0.47	0.55	0.61	0.87	1.22	0.053									
	NFD 050	1/4 3/8 1/2	0.078	0.25	0.35	0.50	0.61	0.70	0.78	1.10	1.56	0.059									
	NFD 059	1/4 3/8 1/2	0.093	0.29	0.42	0.59	0.72	0.83	0.93	1.32	1.86	0.065	0.28	15°	6.0	3/4"	1.12	2.00			
	NFD 077	1/4 3/8 1/2	0.122	0.39	0.55	0.77	0.95	1.10	1.22	1.73	2.44	0.079									
	NFD 097	1/4 3/8 1/2	0.154	0.49	0.69	0.97	1.19	1.38	1.54	2.18	3.08	0.087									
	NFD 12	1/4 3/8 1/2	0.196	0.62	0.88	1.24	1.52	1.75	1.96	2.77	3.92	0.098	0.47	15°	6.0	3/4"	1.12	2.00			
NFD 15	1/4 3/8 1/2	0.233	0.74	1.04	1.47	1.80	2.08	2.33	3.30	4.66	0.106										
NFD 49	1/4 3/8 1/2	0.781	2.47	3.49	4.94	6.05	6.98	7.81	11.0	15.6	0.197										
B	NFD 20	3/4	0.309	0.98	1.38	1.95	2.39	2.76	3.09	4.37	6.18	0.118	0.94	6.0	1/2"	0.88	1.75				
	NFD 25	3/4	0.392	1.24	1.75	2.48	3.04	3.50	3.92	5.54	7.84	0.138									
	NFD 31	3/4	0.488	1.54	2.18	3.09	3.78	4.37	4.88	6.90	9.76	0.157									
	NFD 39	3/4	0.612	1.94	2.74	3.87	4.74	5.48	6.12	8.65	12.2	0.177	0.59	6.0	3/4"	1.12	2.00				
	NFD 50	3/4	0.785	2.48	3.51	4.95	6.08	7.02	7.85	11.1	15.6	0.197									
	NFD 62	3/4	0.981	3.10	4.39	6.21	7.60	8.77	9.81	13.9	19.6	0.217									
	NFD 77	3/4	1.22	3.87	5.48	7.72	9.49	11.0	12.2	17.2	24.4	0.236	0.36	15°	3/4"	1.12	2.00				
	NFD 87	3/4	1.37	4.34	6.14	8.66	10.6	12.3	13.7	19.4	27.4	0.252									
	NFD 104	3/4	1.64	5.19	7.34	10.4	12.7	14.7	16.4	23.2	32.8	0.283									
	NFD 124	3/4	1.96	6.20	8.77	12.4	15.2	17.5	19.6	27.7	39.2	0.315	0.79	6.0	3/4"	1.12	2.00				
NFD 155	3/4	2.45	7.75	11.0	15.5	19.0	21.9	24.5	34.6	49.0	0.354										
NFD 195	3/4	3.08	9.75	13.8	19.5	23.9	27.6	30.8	43.6	61.6	0.394										
C	NFD 124	1- 1/4	1.96	6.20	8.77	12.4	15.2	17.5	19.6	27.7	39.2	0.315	1.51	0.87	0.53	1.26	15°	8.0	1-1/4"	1.75	2.50
	NFD 195	1- 1/4	3.08	9.75	13.8	19.5	23.9	27.6	30.8	43.6	61.6	0.394									
	NFD 309	1- 1/4	4.88	15.4	21.8	30.9	37.8	43.7	48.8	69.1	97.6	0.475									
	NFD 496**	1- 1/4	7.85	24.8	35.1	49.6	60.8	70.2	78.5	111	157	0.591									

**NFD 496 not available in 120°

Flow Rate (GPM) = K √PSI *NPT, BSP, male or female or weldable pipe connections. Dimensions are for male base; female and weldable vary.

Standard Materials: Brass, 303 Stainless Steel and 316 Stainless Steel. Weldable adapters also available in mild steel.

Spray angle performance varies with pressure. Contact BETE for specific data on critical applications.

TO ORDER: specify pipe size, connection type, nozzle number, spray angle, and material.

NFS

Stubby Flat Fan

DESIGN FEATURES

- Extremely short length for minimum projection and maximum clearance
- Produces a flat fan spray pattern available in a variety of spray angles
- Available in straight (parallel) threads only, NPSM and G
- Requires gasket to seal connection

SPRAY CHARACTERISTICS

Spray pattern: Fan

Spray angles: 20°, 30°, 45°, 60°, 90° and 120° standard

Flow rates: 0.049 to 295 gpm



Metal

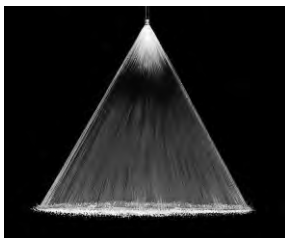

Fan 45°



Fan 90°

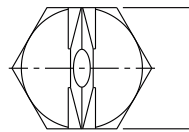
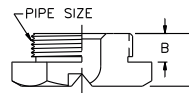

Metal

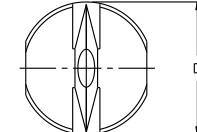
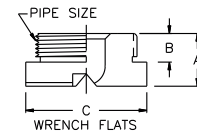

Plastic

Dimensions are approximate. Check with BETE for critical dimension applications.

NFS Flow Rates and Dimensions

Flat Fan, 20°, 30°, 45°, 60°, 90° & 120° Spray Angles, 1/4" to 2" Pipe Sizes

NFS Dimensions and Spray Angles

** Male Pipe Size	Nozzle Number	K Factor	GALLONS PER MINUTE @ PSI											Equiv. Orifice Dia. (in)
			5 PSI	10 PSI	15 PSI	20 PSI	30 PSI	40 PSI	60 PSI	80 PSI	100 PSI	150 PSI	200 PSI	
1/4	NFS 012	0.020	0.04	0.06	0.08	0.09	0.11	0.12	0.15	0.18	0.20	0.24	0.28	0.0315
	NFS 019	0.031	0.07	0.10	0.12	0.14	0.17	0.19	0.24	0.28	0.31	0.38	0.44	0.0394
	NFS 031	0.049	0.11	0.16	0.19	0.22	0.27	0.31	0.38	0.44	0.49	0.60	0.70	0.0472
	NFS 039	0.061	0.14	0.19	0.24	0.27	0.34	0.39	0.47	0.55	0.61	0.75	0.87	0.0531
	NFS 050	0.078	0.18	0.25	0.30	0.35	0.43	0.50	0.61	0.70	0.78	0.96	1.11	0.0591
	NFS 059	0.093	0.21	0.29	0.36	0.42	0.51	0.59	0.72	0.83	0.93	1.14	1.32	0.0650
	NFS 077	0.122	0.27	0.39	0.47	0.55	0.67	0.77	0.95	1.10	1.22	1.50	1.73	0.0787
	NFS 098	0.155	0.35	0.49	0.60	0.69	0.85	0.98	1.20	1.38	1.55	1.89	2.19	0.0866
	NFS 12	0.196	0.44	0.62	0.76	0.88	1.07	1.24	1.52	1.75	1.96	2.40	2.77	0.0984
	NFS 15	0.233	0.52	0.74	0.90	1.04	1.28	1.47	1.80	2.08	2.33	2.85	3.29	0.106
1/4 or 3/4"	NFS 20	0.309	0.69	0.98	1.20	1.38	1.69	1.97	2.39	2.76	3.09	3.78	4.36	0.118
	NFS 25	0.392	0.88	1.24	1.52	1.75	2.15	2.48	3.04	3.51	3.92	4.80	5.55	0.138
	NFS 31	0.492	1.10	1.56	1.91	2.20	2.70	3.11	3.81	4.40	4.92	6.03	6.96	0.157
	NFS 39	0.612	1.37	1.94	2.37	2.74	3.35	3.87	4.74	5.48	6.12	7.50	8.66	0.177
	NFS 50	0.785	1.75	2.48	3.04	3.51	4.30	4.96	6.08	7.02	7.85	9.61	11.1	0.197
	NFS 62	0.981	2.19	3.10	3.80	4.39	5.37	6.25	7.60	8.77	9.81	12.0	13.9	0.217
	NFS 77	1.22	2.74	3.87	4.74	5.48	6.71	7.75	9.49	11.0	12.2	15.0	17.3	0.236
3/4"	NFS 93	1.47	3.28	4.65	5.69	6.57	8.05	9.29	11.4	13.1	14.7	18.0	20.8	0.272
3/4" or 1-1/4"	NFS 124	1.96	4.39	6.20	7.60	8.77	10.7	12.4	15.2	17.5	19.6	24.0	27.7	0.315
	NFS 155	2.45	5.48	7.75	9.49	11.0	13.4	15.5	19.0	21.9	24.5	30.0	34.6	0.354
	NFS 185	2.92	6.53	9.24	11.3	13.1	16.0	18.5	22.6	26.1	29.2	35.8	41.3	0.374
	NFS 195	3.09	6.91	9.77	12.0	13.8	16.9	19.5	23.9	27.6	30.9	37.8	43.7	0.394
1-1/4"	NFS 309	4.88	10.9	15.4	18.9	21.8	26.7	30.9	37.8	43.7	48.8	59.8	69.1	0.472
	NFS 496	7.85	17.5	24.8	30.4	35.1	43.0	49.6	60.8	70.2	78.5	96.1	111	0.591
2	NFS 557	8.81	19.7	27.8	34.1	39.4	48.2	55.7	68.2	78.8	88.1	108	125	0.630
	NFS 620	9.81	21.9	31.0	38.0	43.9	53.7	62.0	76.0	87.7	98.1	120	139	0.669
	NFS 775	12.2	27.4	38.7	47.4	54.8	67.1	77.5	94.9	110	122	150	173	0.748
	NFS 977	15.5	34.5	48.9	59.8	69.1	84.6	97.7	120	138	155	189	219	0.827
	NFS 1130	17.9	40.0	56.6	69.3	80.0	98.0	113	139	160	179	219	253	0.886
	NFS 1320	20.9	46.6	65.9	80.8	93.3	114	132	162	187	209	255	295	0.965

Pipe Size	Nozzle Number	Spray Angles Available	Dimensions (in)			
			A	B	C	D
1/4	NFS 012 To NFS 39	20° 30° 45° 60° 90° 120°	0.47			
	NFS 50	20° 30° 45° 60° 90°	0.69			
	NFS 62	45° 60° 90°	0.75			
	NFS 77	45°	0.75			
	NFS 20 To NFS 77	20° 30° 45° 60° 90° 120°	0.59			
3/4	NFS 93*	120°	0.31			
	NFS 124	20° 30° 45° 60° 90° 120°	1.25			
	NFS 155	20° 30° 45° 60° 90° 120°	1.38			
	NFS 185	120°	1.38			
1-1/4	NFS 124 To NFS 496	20° 30° 45° 60° 90° 120°	0.87	0.47	2.0	
	NFS 557 To NFS 1320	20° 30° 45° 60° 90° 120°	1.25	0.79	2.75	

Flow Rate (GPM) = $K \sqrt{PSI}$ **Available in straight (parallel) threads only, NPSM and G.

Standard Materials: Brass, 316 Stainless Steel, 303 Stainless Steel and PVC.

Spray angle performance varies with pressure. Contact BETE for specific data on critical applications.

FF

Extra-Wide Angle

DESIGN FEATURES

- One-piece construction
- Clog-resistant
- Durable
- All 3/8" FFs in Brass are available with UL approval
- Male connection

SPRAY CHARACTERISTICS

- Extra-wide 105° and 145° spray angles
 - Medium-impact spray
 - Spray discharge deflected 75° from inlet axis
 - Coarse atomization
- Spray pattern:** Flat Fan
Spray angle: 105° or 145°, as listed
Flow rates: 0.014 to 235 gpm



Plastic



Fan 145°

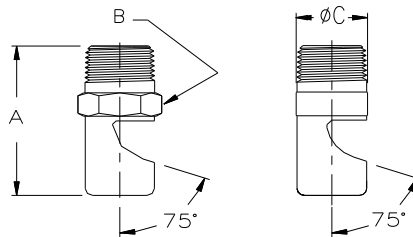

Metal

Plastic

Dimensions are approximate. Check with BETE for critical dimension applications.

FF Flow Rates

Fan, 105° and 145° Spray Angles, 1/8" to 1" Pipe Sizes

Male Pipe Size	Nozzle Number	Spray Angle	K Factor	GALLONS PER MINUTE @ PSI												Approx. Orifice Dia. (in.)
				3 PSI	5 PSI	10 PSI	20 PSI	30 PSI	40 PSI	50 PSI	60 PSI	80 PSI	100 PSI	200 PSI		
1/8	FF016	105°	0.00791	0.014	0.018	0.025	0.035	0.043	0.050	0.056	0.061	0.071	0.079	0.112	0.016	
	FF024	105°	0.0158	0.027	0.035	0.050	0.071	0.087	0.100	0.112	0.122	0.141	0.158	0.224	0.024	
	FF028	105°	0.0237	0.041	0.053	0.075	0.106	0.130	0.150	0.168	0.184	0.212	0.237	0.335	0.028	
	FF033	105°	0.0316	0.055	0.071	0.100	0.141	0.173	0.200	0.224	0.245	0.283	0.316	0.447	0.033	
	FF041	145°	0.0474	0.082	0.106	0.150	0.212	0.260	0.300	0.335	0.367	0.424	0.474	0.671	0.041	
	FF046	145°	0.0632	0.110	0.141	0.200	0.283	0.346	0.400	0.447	0.490	0.566	0.632	0.894	0.046	
	FF052	145°	0.0791	0.137	0.177	0.250	0.354	0.433	0.500	0.559	0.612	0.707	0.791	1.11	0.052	
	FF057	145°	0.0949	0.164	0.212	0.300	0.424	0.520	0.600	0.671	0.735	0.849	0.949	1.34	0.057	
	FF065	145°	0.126	0.219	0.283	0.400	0.566	0.693	0.800	0.894	0.980	1.13	1.26	1.79	0.065	
1/8 or 1/4	FF073	145°	0.158	0.274	0.354	0.500	0.707	0.866	1.00	1.12	1.22	1.41	1.58	2.24	0.073	
	FF093	145°	0.237	0.411	0.530	0.750	1.06	1.30	1.50	1.68	1.84	2.12	2.37	3.35	0.093	
	FF104	145°	0.316	0.548	0.707	1.00	1.41	1.73	2.00	2.24	2.45	2.83	3.16	4.47	0.104	
	FF116	145°	0.379	0.657	0.849	1.20	1.70	2.08	2.40	2.68	2.94	3.39	3.79	5.37	0.116	
	FF125	145°	0.395	0.685	0.884	1.25	1.77	2.17	2.50	2.80	3.06	3.54	3.95	5.59	0.125	
	FF129	145°	0.474	0.822	1.06	1.50	2.12	2.60	3.00	3.35	3.67	4.24	4.74	6.71	0.129	
	FF141	145°	0.569	0.986	1.27	1.80	2.55	3.12	3.60	4.02	4.41	5.09	5.69	8.05	0.141	
	FF148	145°	0.632	1.10	1.41	2.00	2.83	3.46	4.00	4.47	4.90	5.66	6.32	8.94	0.148	
1/4	FF156	145°	0.696	1.20	1.56	2.20	3.11	3.81	4.40	4.92	5.39	6.22	6.96	9.84	0.156	
	FF161	145°	0.759	1.31	1.70	2.40	3.39	4.16	4.80	5.37	5.88	6.79	7.59	10.7	0.161	
	FF173	145°	0.854	1.48	1.91	2.70	3.82	4.68	5.40	6.04	6.61	7.64	8.54	12.1	0.173	

$$\text{Flow Rate (GPM)} = K \sqrt{\text{PSI}}$$

Standard Materials: Brass, 303 Stainless Steel, 316 Stainless Steel, PVC, and PTFE

(PTFE and PVC not available in nozzles FF016 to FF028; PTFE not available in nozzles FF033 to FF065).

FF Dimensions

Pipe Size	Dim. (in.)			Wt. (oz)	
	A	B	C	M	P
1/8	1.00	0.44	0.50	0.49	0.11
1/4	1.38	0.56	0.63	1.23	0.26

Spray angle performance varies with pressure. Contact BETE for specific data on critical applications.



All 3/8" FFs in Brass are available with UL approval

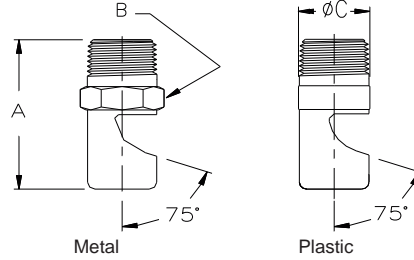

Dimensions are approximate. Check with BETE for critical dimension applications.

FF Flow Rates															FF Dimensions						
Fan, 105° and 145° Spray Angles, 1/8" to 1" Pipe Sizes																					
Male Pipe Size	Nozzle Number	Spray Angle	K Factor	GALLONS PER MINUTE @ PSI											Approx. Orifice Dia. (in.)	Pipe Size	Dim. (in.)			Wt. (oz)	
				3 PSI	5 PSI	10 PSI	20 PSI	30 PSI	40 PSI	50 PSI	60 PSI	80 PSI	100 PSI	200 PSI			A	B	C	M	P
3/8	FF187	145°	0.949	1.64	2.12	3.00	4.24	5.20	6.00	6.71	7.35	8.49	9.49	13.4	0.187	3/8	1.75	0.68	0.75	2.54	0.53
	FF196	145°	1.11	1.92	2.47	3.50	4.95	6.06	7.00	7.83	8.57	9.90	11.1	15.7	0.196						
	FF209	145°	1.18	2.04	2.64	3.73	5.28	6.46	7.46	8.34	9.14	10.1	11.8	16.7	0.209						
	FF218	145°	1.26	2.19	2.83	4.00	5.66	6.93	8.00	8.94	9.80	11.3	12.6	17.9	0.218						
	FF221	145°	1.42	2.46	3.18	4.50	6.36	7.79	9.00	10.1	11.0	12.7	14.2	20.1	0.221						
1/2	FF209	145°	1.18	2.04	2.64	3.73	5.28	6.46	7.46	8.34	9.14	10.1	11.8	16.7	0.209	1/2	2.00	0.88	0.88	4.13	0.88
	FF218	145°	1.26	2.19	2.83	4.00	5.66	6.93	8.00	8.90	9.80	11.3	12.6	17.9	0.218						
	FF250	145°	1.66	2.88	3.71	5.25	7.42	9.09	10.5	11.7	12.9	14.8	16.6	23.5	0.250						
	FF256	145°	1.90	3.29	4.24	6.00	8.49	10.4	12.0	13.4	14.7	17.0	19.0	26.8	0.256						
	FF281	145°	2.21	3.83	4.95	7.00	9.90	12.1	14.0	15.7	17.1	19.8	22.1	31.3	0.281						
	FF312	145°	2.53	4.38	5.66	8.00	11.3	13.9	16.0	17.9	19.6	22.6	25.3	35.8	0.312						
	FF375	145°	3.79	6.57	8.49	12.0	17.0	20.8	24.0	26.8	29.4	33.9	37.9	53.7	0.375						
3/4	FF316	145°	2.85	4.93	6.36	9.00	12.7	15.6	18.0	20.1	22.0	25.5	28.5	40.2	0.316	3/4	2.63	1.38	1.50	12.2	2.57
	FF332	145°	3.16	5.48	7.07	10.0	14.1	17.3	20.0	22.4	24.5	28.3	31.6	44.7	0.332						
	FF348	145°	3.48	6.02	7.78	11.0	15.6	19.1	22.0	24.6	26.9	31.1	34.8	49.2	0.348						
	FF375	145°	3.79	6.57	8.49	12.0	17.0	20.8	24.0	26.8	29.4	33.9	37.9	53.7	0.375						
	FF406	145°	4.43	7.67	9.90	14.0	19.8	24.2	28.0	31.3	34.3	39.6	44.3	62.6	0.406						
	FF437	145°	5.06	8.76	11.3	16.0	22.6	27.7	32.0	35.8	39.2	45.3	50.6	71.6	0.437						
	FF453	145°	5.69	9.86	12.7	18.0	25.5	31.2	36.0	40.2	44.1	50.9	56.9	80.5	0.453						
	FF484	145°	6.64	11.5	14.8	21.0	29.7	36.4	42.0	47.0	51.4	59.4	66.4	93.9	0.484						
	FF500	145°	7.59	13.1	17.0	24.0	33.9	41.6	48.0	53.7	58.8	67.9	75.9	107	0.500						
1	FF578	145°	9.49	16.4	21.2	30.0	42.4	52.0	60.0	67.1	73.5	84.9	94.9	134	0.578	1	3.38	2.00	2.00	32.0	6.77
	FF625	145°	11.5	20.0	25.8	36.5	51.6	63.2	73.0	81.6	89.4	103	115	163	0.625						
	FF703	145°	14.2	24.6	31.8	45.0	63.6	77.9	90.0	101	110	127	142	201	0.703						
	FF750	145°	16.6	28.8	37.1	52.5	74.2	90.9	105	117	129	148	166	235	0.750						

Flow Rate (GPM) = $K \sqrt{PSI}$

Standard Materials: Brass, 303 Stainless Steel, 316 Stainless Steel, PVC, and PTFE.

Spray angle performance varies with pressure. Contact BETE for specific data on critical applications.



CALL 413-772-0846
Call for the name of your nearest BETE representative.

EZ FF NF SPN

EZ Change Quick Connection System

DESIGN FEATURES

- Nozzles can be changed in seconds without tools
- Three part nozzle, base, gasket and interchangeable tip
- Exclusive ramped engagement for efficient automatic alignment
- Threaded adapters will accommodate other standard BETE nozzles. Shut-off plugs are also available.
- Sanitary EZs are available with weld connection and no knurling

SPRAY CHARACTERISTICS

- Available in six standard tips: EZFF; EZNF; EZSPN; EZWL; EZTF, and EZWT

More EZ tips:

Full Cone: page 30
Hollow Cone: page 46

Flow rates: 0.02 to 42.5 gpm

Spray Angle:

EZFF: 105° and 145°
EZNF: 0°, 15°, 30°, 50°, 65°, 80°, 90°, 110°, 120°
EZSPN: 15°, 25°, 35°, 40° and 50°



EZNF



145° Fan



50° Fan



Base

Gasket

Tip

Dimensions are approximate. Check with BETE for critical dimension applications.

EZFF Flow Rates and Dimensions

Deflected Flat Fan 105° and 145° Spray Angles 1/8" to 1/2" Pipe Sizes

Pipe Size	Nozzle Number	K Factor	GALLONS PER MINUTE @ PSI											Approx. Orifice Dia. (in.)	Pipe Size	Approx. Assembly Dim. (in.) Hex Length	Wt. (oz.)
			5 PSI	10 PSI	20 PSI	30 PSI	40 PSI	60 PSI	80 PSI	100 PSI	200 PSI	400 PSI	500 PSI				
1/8"	EZFF016*	0.00791	0.02	0.02	0.03	0.04	0.05	0.06	0.07	0.08	0.11	0.16	0.18	0.016	1/8"	0.88 1.99	2.2
	EZFF024*	0.0158	0.03	0.05	0.71	0.09	0.10	0.12	0.14	0.16	0.22	0.32	0.35	0.024			
	EZFF028*	0.0237	0.05	0.07	0.11	0.13	0.15	0.18	0.21	0.237	0.34	0.47	0.53	0.028			
	EZFF033*	0.0316	0.07	0.10	0.14	0.17	0.20	0.24	0.28	0.32	0.48	0.63	0.71	0.033			
	EZFF041	0.0474	0.11	0.15	0.21	0.26	0.30	0.37	0.42	0.47	0.67	0.95	1.06	0.041			
	EZFF046	0.0632	0.14	0.20	0.25	0.37	0.40	0.49	0.57	0.63	0.89	1.26	1.41	0.046			
	EZFF052	0.0791	0.18	0.25	0.35	0.43	0.50	0.61	0.71	0.79	1.11	1.58	1.77	0.052			
	EZFF057	0.0949	0.21	0.30	0.42	0.52	0.60	0.74	0.85	0.95	1.34	1.90	2.12	0.057			
TO	EZFF065	0.126	0.28	0.40	0.57	0.69	0.80	0.98	1.13	1.26	1.79	2.52	2.82	0.065	1/4"	0.88 2.11	2.2
	EZFF073	0.158	0.35	0.50	0.71	0.87	1.00	1.22	1.41	1.58	2.24	3.16	3.53	0.073			
	EZFF093	0.237	0.53	0.75	1.06	1.30	1.50	1.84	2.12	2.37	3.35	4.74	5.30	0.093			
	EZFF104	0.316	0.71	1.00	1.41	1.73	2.00	2.45	2.83	3.16	4.47	6.32	7.07	0.104			
	EZFF116	0.379	0.85	1.20	1.70	2.08	2.40	2.94	3.39	3.79	5.37	7.58	8.48	0.116			
	EZFF125	0.395	0.88	1.25	1.77	2.17	2.50	3.06	3.54	3.95	5.59	7.90	8.83	0.125			
	EZFF129	0.474	1.06	1.50	2.12	2.60	3.00	3.67	4.24	4.74	6.71	9.48	10.6	0.129			
	EZFF141	0.569	1.27	1.80	2.55	3.12	3.60	4.41	5.09	5.69	8.05	11.4	12.7	0.141			
1/2"	EZFF148	0.632	1.41	2.00	2.83	3.46	4.00	4.90	5.66	6.32	8.94	12.6	14.1	0.148	3/8"	0.88 2.17	2.6
	EZFF156	0.696	1.58	2.20	3.11	3.81	4.40	5.39	6.22	6.96	9.84	13.9	15.6	0.156			
	EZFF161	0.759	1.70	2.40	3.39	4.16	4.80	5.88	6.79	7.59	10.7	15.2	17.0	0.161			
	EZFF173	0.854	1.91	2.70	3.82	4.68	5.40	6.61	7.64	8.54	12.1	17.1	19.1	0.173			
	EZFF187	0.949	2.12	3.00	4.24	5.20	6.00	7.35	8.49	9.49	13.4	19.0	21.2	0.187			
	EZFF196	1.11	2.47	3.50	4.95	6.06	7.00	8.57	9.90	11.1	15.7	22.2	24.8	0.196			
	EZFF218	1.26	2.83	4.00	5.66	6.93	8.00	9.80	11.3	12.6	17.9	25.2	28.2	0.218			
	EZFF221	1.42	3.18	4.50	6.36	7.79	9.00	11.0	12.7	14.2	20.1	28.4	31.8	0.221			
TO	EZFF250	1.66	3.71	5.25	7.42	9.09	10.5	12.9	14.8	16.6	23.5	33.2	37.1	0.250	1/2"	0.88 2.23	2.9
	EZFF256	1.90	4.24	6.00	8.49	10.4	12.0	14.7	17.0	19.0	26.8	38.0	42.5	0.256			

Flow Rate (GPM) = $K \sqrt{PSI}$

*Available in 105° only; all others 145° FF218 - FF256 not available with 1/8" base

Standard Materials: 303 Stainless Steel, 316 Stainless Steel, Brass, Viton gaskets standard.

Spray angle performance varies with pressure. Contact BETE for specific data on critical applications.

TO ORDER: specify pipe size, connection type, nozzle number, spray angle, and material.

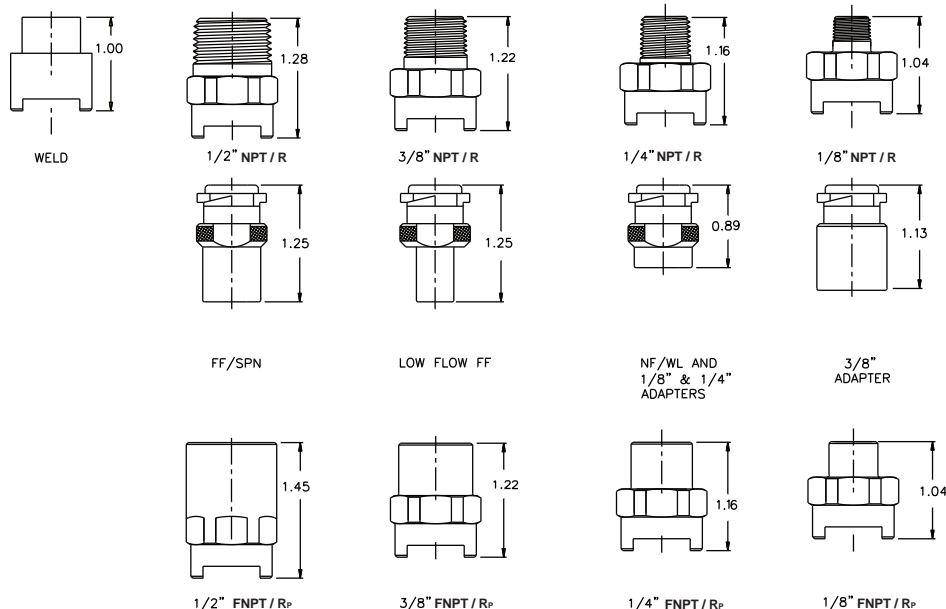

Dimensions are approximate. Check with BETE for critical dimension applications.

EZNF Flow Rates and Dimensions

Fan and Straight Jet 0°, 15°, 30°, 50°, 65°, 80°, 90°, 110° and 120° Spray Angles 1/8" to 1/2" Pipe Sizes

Pipe Size	Nozzle Number	K Factor	GALLONS PER MINUTE @ PSI											Equivalent Orifice Dia. (in.)	Approx. Assembly Dim. (in.)		Wt. (oz.)	
			5 PSI	10 PSI	20 PSI	30 PSI	40 PSI	60 PSI	80 PSI	100 PSI	200 PSI	400 PSI	500 PSI		Hex	Length		
1/8"	EZNF01	0.0158	0.03	0.05	0.07	0.09	0.10	0.12	0.14	0.16	0.22	0.31	0.35	0.026	1/8"	0.88	1.63	2.2
	EZNF015	0.0237	0.05	0.07	0.11	0.13	0.15	0.18	0.21	0.24	0.33	0.47	0.53	0.031				
	EZNF02	0.0316	0.07	0.10	0.14	0.17	0.20	0.24	0.28	0.32	0.48	0.63	0.71	0.036				
	EZNF025	0.0395	0.09	0.12	0.18	0.22	0.25	0.31	0.35	0.40	0.56	0.79	0.88	0.040				
	EZNF03	0.0474	0.11	0.15	0.21	0.26	0.30	0.37	0.42	0.47	0.67	0.95	1.06	0.043				
	EZNF04	0.0632	0.14	0.20	0.28	0.35	0.40	0.49	0.57	0.63	0.89	1.26	1.41	0.052				
	EZNF05	0.0791	0.18	0.25	0.35	0.43	0.50	0.61	0.71	0.79	1.12	1.58	1.77	0.057				
TO	EZNF06	0.0949	0.21	0.30	0.42	0.52	0.60	0.73	0.85	0.95	1.34	1.90	2.12	0.062	1/4"	0.88	1.75	2.2
	EZNF08	0.126	0.28	0.40	0.57	0.69	0.80	0.98	1.13	1.26	1.79	2.53	2.83	0.072				
	EZNF10	0.158	0.35	0.50	0.71	0.87	1.00	1.22	1.41	1.58	2.24	3.16	3.54	0.080				
	EZNF15	0.237	0.53	0.75	1.06	1.30	1.50	1.84	2.12	2.37	3.35	4.74	5.30	0.094				
1/2"	EZNF20	0.316	0.71	1.00	1.41	1.73	2.00	2.45	2.83	3.16	4.47	6.32	7.07	0.109	3/8"	0.88	1.81	2.6
	EZNF30	0.474	1.06	1.50	2.12	2.60	3.00	3.67	4.24	4.74	6.71	9.49	10.6	0.141				
	EZNF40	0.632	1.41	2.00	2.83	3.46	4.00	4.90	5.66	6.32	8.94	12.6	14.1	0.156				
	EZNF50	0.791	1.77	2.50	3.54	4.33	5.00	6.12	7.07	7.91	11.2	15.8	17.7	0.172				
	EZNF60	0.949	2.12	3.00	4.24	5.20	6.00	7.35	8.49	9.49	13.4	19.0	21.2	0.185				
1/4" - 1/2"	EZNF70	1.11	2.47	3.50	4.95	6.06	7.00	8.57	9.90	11.1	15.6	22.1	24.8	0.203	1/2"	0.88	1.87	2.9
	EZNF80	1.26	2.83	4.00	5.66	6.93	8.00	9.80	11.3	12.6	17.9	25.3	28.3	0.219				
	EZNF90	1.42	3.18	4.50	6.36	7.79	9.00	11.0	12.7	14.2	20.1	28.4	31.8	0.234				

$$\text{Flow Rate (GPM)} = K \sqrt{\text{PSI}}$$

Standard Materials: 303 Stainless Steel, 316 Stainless Steel, Brass, Viton gaskets standard.

EZSPN Flow Rates and Dimensions

Fan 15°, 25°, 35°, 40° and 50° Spray Angles 1/8" to 1/2" Pipe Sizes

Pipe Size	Nozzle Number	Available Spray Angles	K Factor	GALLONS PER MINUTE @ PSI											Equiv. Orifice Dia. (in.)	Deflection Angle @ Spray Angle				Approx. Assembly Dim. (in.)		Wt. (oz.)
				5 PSI	10 PSI	20 PSI	40 PSI	80 PSI	100 PSI	200 PSI	400 PSI	500 PSI	15°	25°		35°	40°	50°	Hex	Length		
1/8"	EZSPN10	15° 35° 50°	0.158	0.35	0.50	0.71	1.00	1.40	1.60	2.20	3.16	3.54	0.057	5°	35°	55°	1/8"	0.88	1.99	2.2		
	EZSPN20	15° 35° 50°	0.316	0.71	1.00	1.41	2.00	2.83	3.16	4.47	6.32	7.07	0.080	5°	35°	45°						
	EZSPN25	50°	0.395	0.88	1.25	1.77	2.50	3.54	3.90	5.59	7.91	8.84	0.094	50°								
TO	EZSPN30	15° 35°	0.474	1.06	1.50	2.12	3.00	4.24	4.74	6.71	9.49	10.6	0.109	5°	28°		1/4"	0.88	2.11	2.2		
	EZSPN40	15° 25° 35° 40° 50°	0.632	1.41	2.00	2.83	4.00	5.66	6.32	9.00	12.6	14.1	0.141	5°	20°	35°						
1/2"	EZSPN50	35° 40°	0.791	1.77	2.50	3.54	5.00	7.07	7.91	11.2	15.8	17.7	0.156	23°	33°		3/8"	0.88	2.17	2.6		
	EZSPN60	15° 35° 40° 50°	0.949	2.12	3.00	4.24	6.00	8.49	9.49	13.4	19.0	21.2	0.172	5°	20°	33°						
	EZSPN70	40°	1.11	2.47	3.50	4.95	7.00	9.90	11.1	15.7	22.1	24.7	0.185	29°								
1/4"	EZSPN80	15° 35° 40° 50°	1.27	2.83	4.00	5.66	8.00	11.3	12.6	17.9	25.3	28.3	0.203	5°	25°	26°	1/2"	0.88	2.23	2.9		
	EZSPN90	40°	1.42	3.18	4.50	6.36	9.00	12.7	14.2	20.1	28.5	31.8	0.219	28°								
1/2"	EZSPN100	15° 35° 40° 50°	1.58	3.54	5.00	7.07	10.0	14.1	15.8	22.4	31.6	35.4	0.234	5°	25°	28°						

$$\text{Flow Rate (GPM)} = K \sqrt{\text{PSI}} \quad \text{SPN80 - SPN100 not available with 1/8" base}$$

Standard Materials: 303 Stainless Steel, 316 Stainless Steel, Brass, Viton gaskets standard.

Spray angle performance varies with pressure. Contact BETE for specific data on critical applications.



Call for the name of your nearest BETE representative.
CALL 413-772-0846

SF

Snap Release Nozzle System

DESIGN FEATURES

- Nozzles can be quickly changed and aligned by hand without tools
- Clamp-on adapter fits any style nozzle
- Quick set-up system features special "Snap-in" tips
- Polypropylene, resistant to most acids and alkalis
- Double clamp base or adapter available for higher pressure operation

SPRAY CHARACTERISTICS

- Quick Set-up System can be provided with fan, hollow or full cone spray tips
- Full 45° alignment of spray without tools

More SF Nozzle Systems:

Full Cone: page 31

Hollow Cone: page 48

Flow rates: 0.35 to 15.8 gpm

Spray angles:

Fan: 40°, 50°, 65°, 80°, 95°

Hollow Cone: 50°, 65°, 90°

Full Cone: 35°, 65°, 80°



Snap-In Fan Tip



50° Fan

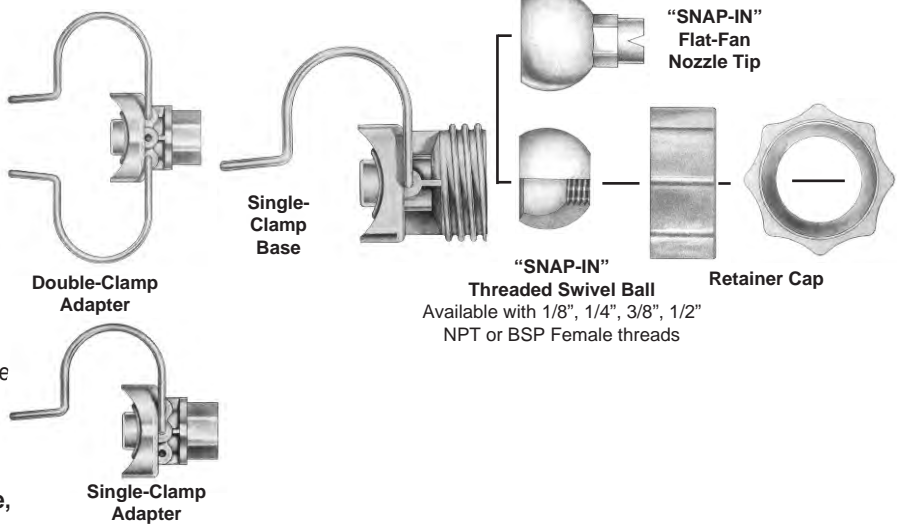
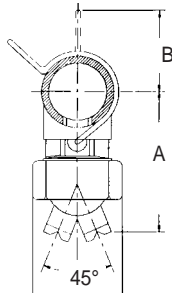

CLAMP-ON ADAPTER

- Available for 1", 1-1/4", 1-1/2" and 2" pipe.
- Available with 1/8", 1/4", 3/8", 1/2" NPT female or 1/8" BSP female threads
- Available with single or double clamp.

TO ORDER ADAPTER

Specify: Pipe Size, thread size, thread type, number of clamps, materials.

SF Flow Rates and Dimensions

SF Fan 40°, 50°, 65°, 80°, 95° Spray Angles 1", 1-1/4", 1-1/2" and 2" Pipe Sizes

Nozzle No.	Available Spray Angles	K Factor	GALLONS PER MINUTE @ PSI									Equiv. Orifice Dia. (in.)	Pipe Size	Body Color	Approx. Dim. (in.)		Wt. (oz.)
			5 PSI	10 PSI	15 PSI	20 PSI	30 PSI	40 PSI	60 PSI	80 PSI	100 PSI				A	B	
SF10	80°	0.158	0.35	0.50	0.61	0.71	0.87	1.00	1.22	1.41	1.58	0.078	1"	blue	3.3	1.7	2.0
SF20	65°	0.316	0.71	1.00	1.22	1.41	1.73	2.00	2.45	2.83	3.16	0.109	1-1/4"	red	3.4	1.9	2.2
SF30	65°	0.474	1.06	1.50	1.84	2.12	2.60	3.00	3.67	4.24	4.74	0.141	1-1/2"	purple	3.6	2.0	2.2
SF40	65°	0.632	1.41	2.00	2.45	2.83	3.46	4.00	4.90	5.66	6.32	0.156	2"	green	3.7	2.2	2.2
SF50	40° 50° 65°	0.791	1.77	2.50	3.06	3.54	4.33	5.00	6.12	7.07	7.91	0.172	2"	green	3.7	2.2	2.2
SF60	50° 65° 80° 95°	0.949	2.12	3.00	3.67	4.24	5.20	6.00	7.35	8.49	9.49	0.188	2"	green	3.7	2.2	2.2
SF70	50° 80°	1.11	2.47	3.50	4.29	4.95	6.06	7.00	8.57	9.90	11.1	0.203	2"	green	3.7	2.2	2.2
SF100	50°	1.58	3.53	5.00	6.12	7.07	8.65	10.0	12.2	14.1	15.8	0.250	2"	green	3.7	2.2	2.2

Flow Rate (GPM) = $K\sqrt{PSI}$

Standard Materials: Polypropylene, 302 Stainless Steel clamp, EPDM seal.

Optional Materials: Viton seal.

NOTE: Drill 21/32" hole in pipe to install SF.

NOTE: Maximum recommended working pressures for SF assemblies: with single clamp, 70 psi for 1" pipe; 50 psi for 1-1/4" and 1-1/2" pipe; and 35 psi for 2" pipe; with double clamp up to 150 psi.

Spray angle performance varies with pressure. Contact BETE for specific data on critical applications.

TO ORDER: specify pipe size, connection type, nozzle number, spray angle, and material.

SPN

High Impact/Narrow Fan Spray

DESIGN FEATURES

- One-piece/heavy construction
- Straight-through orifice minimizes clogging
- Machined from bar stock to exacting standards
- Male connection

SPRAY CHARACTERISTICS

- Yields highest impact, narrow flat spray with least atomization
- Spoon-shaped deflector surface efficiently forms a hard-driving spray

Spray pattern: Fan

Spray angles: 15°, 25°, 35°, 40°, 50°

Flow rates: 0.50 to 44.7 gpm

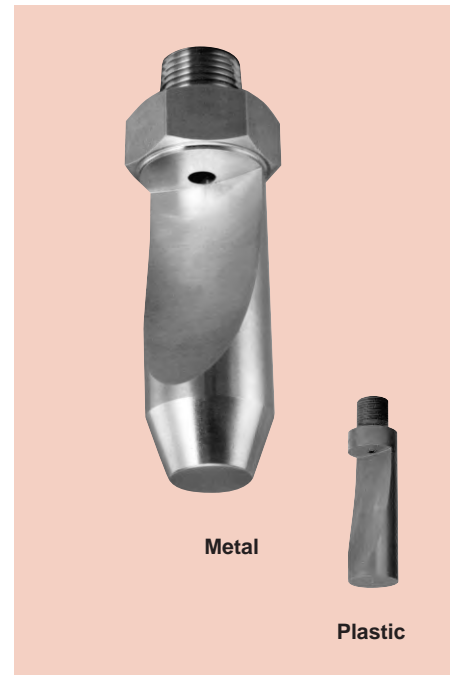

Fan 50°

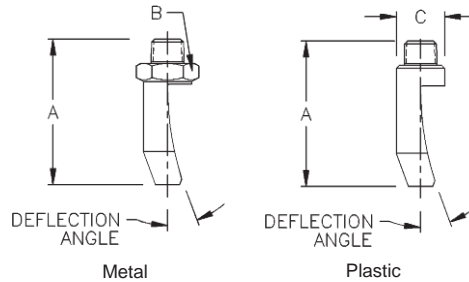

Dimensions are approximate. Check with BETE for critical dimension applications.

SPN Flow Rates and Dimensions

Fan, 15°, 25°, 35°, 40° and 50° Spray Angles, 1/8" to 3/4" Pipe Sizes

Male Pipe Size	Nozzle Number	Available Spray Angles	K Factor	GALLONS PER MINUTE @ PSI										Approx. Orifice Dia. (in.)	Deflection Angle @ Spray Angle					Dimensions (inches) Metals Only			Wt (oz) Metal
				10 PSI	20 PSI	30 PSI	40 PSI	50 PSI	60 PSI	80 PSI	100 PSI	200 PSI	15°		25°	35°	40°	50°	A	B	C		
1/8	SPN 04	35°	0.063	0.20	0.28	0.35	0.40	0.45	0.49	0.56	0.63	0.89	0.049	15°					0.70	0.50	0.56	0.50	
		15° 35° 50°	0.158	0.50	0.71	0.87	1.00	1.12	1.21	1.40	1.58	2.20	0.078	5°	35°	55°	2.00	0.88	0.75	2.50			
		15° 35° 50°	0.316	1.00	1.41	1.73	2.00	2.24	2.50	2.80	3.16	4.50	0.109	5°	35°	45°							
		15° 35° 50°	0.395	1.30	1.80	2.20	2.50	2.80	3.10	3.50	3.95	5.60	0.120	50°									
25°	0.633	2.00	2.83	3.50	4.00	4.47	4.90	5.66	6.33	8.90	0.152	20°			45°								
3/8	SPN 20	35°	0.316	1.00	1.41	1.73	2.00	2.24	2.40	2.83	3.16	4.50	0.109	30°					3.00	1.12	1.00	8.00	
		15° 35° 50°	0.395	1.25	1.77	2.17	2.50	2.80	3.06	3.54	3.95	5.59	0.120	5°	28°	45°							
		15° 35° 50°	0.474	1.50	2.12	2.60	3.00	3.35	3.67	4.24	4.74	6.71	0.125	5°	28°								
		15° 35° 40° 50°	0.633	2.00	2.83	3.46	4.00	4.47	4.90	5.66	6.33	9.00	0.152	5°	35°	35° 50°							
		15° 35° 40° 50°	0.791	2.50	3.54	4.33	5.00	5.59	6.12	7.07	7.91	11.2	0.171	5°	23°	33°							
		15° 35° 40° 50°	0.949	3.00	4.24	5.20	6.00	6.71	7.35	8.49	9.49	13.4	0.187	5°	20°	33° 35°							
		15° 35° 40° 50°	1.11	3.50	4.95	6.06	7.00	7.83	8.57	9.90	11.1	15.7	0.199	5°	29°								
		15° 35° 40° 50°	1.26	4.00	5.66	6.93	8.00	8.90	9.80	11.3	12.6	17.9	0.209	5°	25°	26° 35°							
		15° 35° 40° 50°	1.42	4.50	6.36	7.80	9.00	10.1	11.0	12.7	14.2	20.1	0.218	28°									
		15° 35° 40° 50°	1.58	5.00	7.10	8.60	10.0	11.2	12.2	14.1	15.8	22.3	0.234	5°	25°	28° 40°							
		15° 35° 50°	1.90	6.00	8.49	10.4	12.0	13.4	14.7	17.0	19.0	26.8	0.265	5°	25°	40°							
		15° 35° 50°	1.98	6.25	8.84	10.8	12.5	14.0	15.3	17.7	19.8	28.0	0.272	38°									
		15° 35° 50°	2.53	8.00	11.3	13.9	16.0	17.9	19.6	23.0	25.3	35.8	0.312	25°			37°						
		15° 35° 50°	3.16	10.0	14.2	17.0	20.0	22.4	24.0	28.0	31.6	44.7	0.328	32°									
1/2	SPN 60	15° 35°	0.949	3.00	4.24	5.20	6.00	6.71	7.35	8.49	9.49	13.4	0.187	5°	27°	4.50	1.38	1.25	19.0				
		15° 35° 50°	1.26	4.00	5.66	6.93	8.00	8.14	9.80	11.3	12.6	17.9	0.209	5°	25°								
		15° 35° 50°	1.58	5.00	7.10	8.60	10.0	11.2	12.2	14.1	15.8	22.4	0.234	5°	19°								
		15° 35° 50°	2.21	7.00	10.0	12.0	14.0	15.7	17.0	20.0	22.1	32.0	0.296	5°	25°					40°			
		15° 35° 50°	2.53	8.00	11.3	13.9	16.0	17.9	19.5	22.5	25.2	35.5	0.312	5°	25°					40°			
3/4	SPN 160	35°	2.53	8.00	11.3	13.9	16.0	17.9	19.6	22.6	25.3	35.8	0.312	23°			4.88	1.75	1.69	30.0			
		15° 35°	3.16	10.0	14.2	17.0	20.0	22.4	24.0	28.0	31.6	44.7	0.328	22°									

Flow Rate (GPM) = $K\sqrt{PSI}$

Standard Materials: Brass, 303 Stainless Steel, 316 Stainless Steel, PVC and PTFE.

Spray angle performance varies with pressure. Contact BETE for specific data on critical applications.



MicroWhirl®

Fine Atomization

DESIGN FEATURES

- Outstanding atomization
- Rugged pinless design
- Drip-free performance
- Standard: 70 micron polypropylene filter
 - Optional: 200-mesh 316SS screen
- Safety wire hole available
- Patented design
- Minimum operating pressure 100 psi

SPRAY CHARACTERISTICS

- Mist at low pressure; fog at high pressure

Spray pattern: Cone-shaped Fog

Flow rates: 0.009 - 0.380 gpm

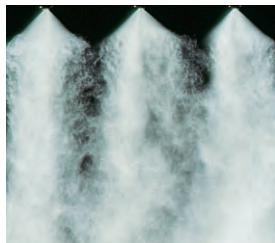

Fog

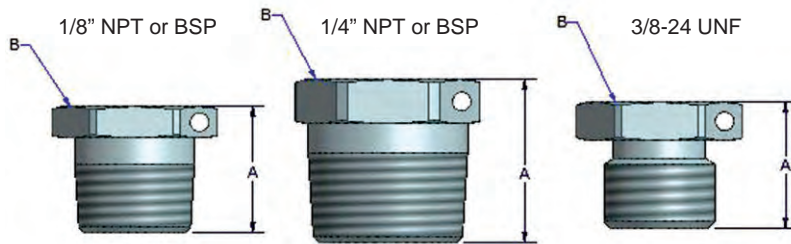

Shown with optional 1/16" diameter safety wire hole

Dimensions (in.)

Pipe Size	A	B
1/8"	0.485	0.438
1/4"	0.690	0.563
3/8-24UNF	0.425	0.5

Dimensions are approximate. Check with BETE for critical dimension applications.

MicroWhirl Flow Rates and Dimensions

Fogging, 70° Spray Angle, 1/8", 1/4" BSP or NPT or 3/8" - 24 UNF Pipe Sizes

Male Pipe Size	Nozzle Number	K Factor	GALLONS PER MINUTE @ PSI								Wt (oz)
			100 psi	300 psi	600 psi	1000 psi	1500 psi	2000 psi	2500 psi	3000 psi	
1/8"	MW085	0.00085	0.009	0.015	0.021	0.027	0.033	0.038	0.043	0.047	0.25
	MW105	0.00105	0.011	0.018	0.026	0.033	0.041	0.047	0.053	0.058	
	MW125	0.00125	0.013	0.022	0.031	0.040	0.048	0.056	0.063	0.068	
1/4"	MW145	0.00145	0.015	0.025	0.036	0.046	0.056	0.065	0.073	0.079	
	MW195	0.00195	0.020	0.034	0.048	0.062	0.076	0.087	0.098	0.107	
3/8"-24UNF	MW275	0.00275	0.028	0.048	0.067	0.087	0.107	0.123	0.138	0.151	
	MW695	0.00693	0.069	0.120	0.170	0.219	0.268	0.310	0.347	0.380	

Nominal Angle

Atomization Level



$$\text{Flow Rate (GPM)} = K \sqrt{\text{PSI}}$$

Pattern with increasing pressure from nozzle

Standard Materials: 303 and 316 Stainless Steel, Polypropylene filter, and Viton O-ring seal* (*supplied for 3/8"-24 UNF connection)

Spray angle performance varies with pressure. Contact BETE for specific data on critical applications.

MISTING

TO ORDER: specify pipe size, connection type, nozzle number, spray angle, and material.

PJ

Fine Atomization

DESIGN FEATURES

- High energy efficiency
- No whirl vanes or internal parts
- 1/8" or 1/4" male connection
- Standard: 100-mesh 316SS screen
 - Optional: 200-mesh 316SS screen
 - Optional: 20 micron paper filter
 - Optional: 70 micron polypropylene filter
- Optional welded pin and optional safety wire hole

SPRAY CHARACTERISTICS

- Finest fog of any direct pressure nozzle

Spray pattern: Cone-shaped Fog

Spray angle: 90°. For best 90° pattern operate nozzle at or above 60 psi

Flow rates: 0.013 to 1.4 gpm

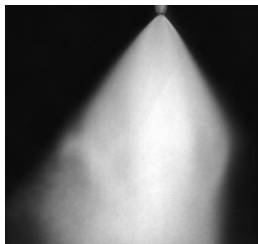

Fog

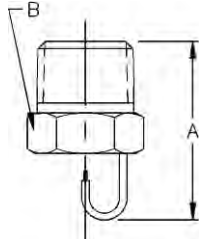

Male

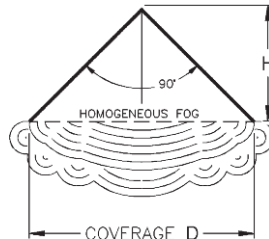

Fog Pattern

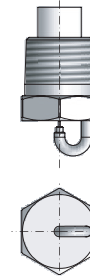

PJ with polypropylene filter

Dimensions are approximate. Check with BETE for critical dimension applications.

PJ Flow Rates and Dimensions

Impingement, 90° Spray Angle, 1/8" or 1/4" Pipe Sizes

Male Pipe Size	Nozzle Number	K Factor	GALLONS PER MINUTE @ PSI										Approx. Orifice Dia. (in.)	Approx. Coverage (inches) D	Approx. Spray Height (in.) H	Pipe Size	Approx. Dim. (in.)		Wt. (oz.) Metal
			10 PSI	30 PSI	40 PSI	50 PSI	60 PSI	80 PSI	100 PSI	200 PSI	400 PSI	A					B		
1/8	PJ6	0.00095				0.006	0.007	0.008	0.010	0.013	0.019	0.006	10	5	1/8	0.75	0.44	0.25	
	PJ8	0.00180			0.013	0.014	0.016	0.018	0.025	0.036	0.008	10	5						
	PJ10	0.00269		0.017	0.019	0.021	0.024	0.027	0.038	0.054	0.010	10	5						
	PJ12	0.00364		0.023	0.026	0.028	0.033	0.036	0.051	0.073	0.012	10	5						
OR	PJ15	0.00585		0.032	0.037	0.041	0.045	0.052	0.059	0.083	0.117	0.015	10	5	1/4	0.97	0.56		
	PJ20	0.0106	0.034	0.058	0.067	0.075	0.082	0.095	0.11	0.15	0.21	0.020	12	6					
	PJ24	0.0158	0.050	0.087	0.10	0.11	0.12	0.14	0.16	0.22	0.32	0.024	16	8					
	PJ28	0.0206	0.065	0.11	0.13	0.15	0.16	0.18	0.21	0.29	0.41	0.028	18	9					
1/4	PJ32	0.0285	0.090	0.16	0.18	0.20	0.22	0.25	0.28	0.40	0.57	0.032	22	11	1/4	0.97	0.56		
	PJ40	0.0443	0.14	0.24	0.28	0.31	0.34	0.40	0.44	0.63	0.89	0.040	24	12					

Flow Rate (GPM) = $K \sqrt{PSI}$

Standard Materials: Brass, 303 Stainless Steel and 316 Stainless Steel.

Spray angle performance varies with pressure. Contact BETE for specific data on critical applications.



P

Fine Atomization

DESIGN FEATURES

- High energy efficiency
- No whirl vanes or internal parts
- Highly efficient laminar jet impinges on target pin generating fine fog
- Male connection

SPRAY CHARACTERISTICS

- Finest fog of any direct pressure nozzle

Spray pattern: Cone-shaped Fog

Spray angle: 90°. For best 90° pattern

operate nozzle at or above 60 psi

Flow rates: 0.034 to 7.68 gpm



MISTING

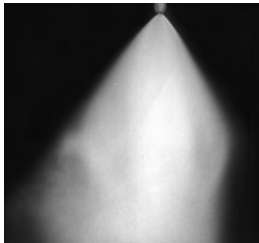

Fog

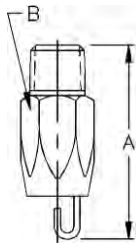

Male

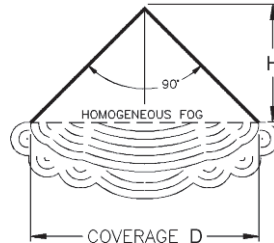

Fog Pattern

Dimensions are approximate. Check with BETE for critical dimension applications.

P Flow Rates and Dimensions

Cone-Shaped Fog, 90° Spray Angle, 1/4" Pipe Size

Male Pipe Size	Nozzle Number	K Factor	GALLONS PER MINUTE @ PSI												Approx. Orifice Dia. (in.)	Approx. Coverage (inches) D	Approx. Spray Height (in.) H	Approx. Dim. (in.)		Wt. (oz.) Metal
			10 PSI	20 PSI	30 PSI	40 PSI	50 PSI	60 PSI	70 PSI	80 PSI	90 PSI	100 PSI	200 PSI	400 PSI				A	B	
1/4	P20	0.0106	0.034	0.047	0.058	0.067	0.075	0.082	0.089	0.095	0.10	0.11	0.15	0.21	0.020	12.0	6	1.83	0.63	2
	P24	0.0158	0.050	0.071	0.087	0.10	0.11	0.12	0.13	0.14	0.15	0.16	0.22	0.32	0.024	16.0	8			
	P28	0.0206	0.065	0.09	0.11	0.13	0.15	0.16	0.17	0.18	0.20	0.21	0.29	0.41	0.028	18.0	9			
	P32	0.0285	0.090	0.13	0.16	0.18	0.20	0.22	0.24	0.25	0.27	0.28	0.40	0.57	0.032	22.0	11			
	P40	0.0443	0.14	0.20	0.24	0.28	0.31	0.34	0.37	0.40	0.42	0.44	0.63	0.89	0.042	24.0	12			
	P48	0.0633	0.20	0.28	0.35	0.40	0.45	0.49	0.53	0.57	0.60	0.63	0.89	1.26	0.047	28.0	14			
	P54	0.0838	0.27	0.37	0.46	0.53	0.59	0.65	0.70	0.75	0.80	0.84	1.19	1.68	0.054	30.0	15			
	P66	0.119	0.38	0.53	0.65	0.75	0.84	0.92	0.99	1.06	1.13	1.19	1.68	2.37	0.065	36.0	18			
	P80	0.171	0.54	0.76	0.94	1.08	1.21	1.32	1.43	1.53	1.62	1.71	2.41	3.42	0.085	48.0	24			
	P120	0.384	1.22	1.72	2.10	2.43	2.72	2.98	3.21	3.44	3.65	3.84	5.43	7.68	0.130	60.0	30			

$$\text{Flow Rate (GPM)} = K \sqrt{\text{PSI}}$$

Standard Materials: Brass, 303 Stainless Steel and 316 Stainless Steel.

Spray angle performance varies with pressure. Contact BETE for specific data on critical applications.

TO ORDER: specify pipe size, connection type, nozzle number, spray angle, and material.

L

Low Flow

DESIGN FEATURES

- A series of small spiral nozzles with orifice diameters of 0.04" to 0.12"
- Male connection

SPRAY CHARACTERISTICS

- Spray pattern:** Hollow Cone Fog, nearly as fine as P Series
- Spray angles:** 90° standard (120° available by special order)
- Flow rates:** 0.14 to 3.84 gpm



Metal



MISTING

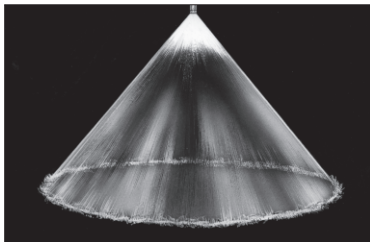

Hollow Cone 90°

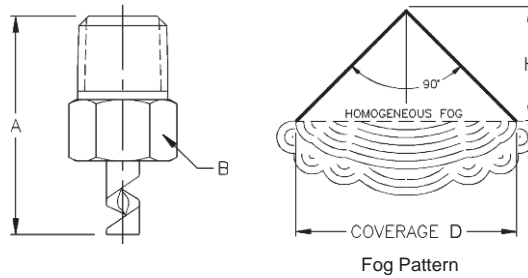

Dimensions are approximate. Check with BETE for critical dimension applications.

L Flow Rates

Hollow Cone, 90° Spray Angle, 1/8" and 1/4" Pipe Sizes, BSP or NPT

L Dimensions BSP or NPT

Male Pipe Size	Nozzle Number	K Factor	GALLONS PER MINUTE @ PSI										Approx. Orifice Dia. (in.)	Spray Dimensions (in.)		Male Pipe Size	Dimensions (in.)		Wt. (oz.) Metal
			10 PSI	20 PSI	30 PSI	40 PSI	50 PSI	60 PSI	70 PSI	80 PSI	90 PSI	100 PSI		D	H		A	B	
1/8	L40	0.044	0.14	0.20	0.24	0.28	0.31	0.34	0.37	0.40	0.42	0.44	0.040	24	12	1/8"	1.12	0.56	0.60
	L48	0.063	0.20	0.28	0.35	0.40	0.45	0.49	0.53	0.57	0.60	0.63	0.048	27	14				
	or	L54	0.084	0.27	0.37	0.46	0.53	0.59	0.65	0.70	0.75	0.80	0.84	0.054	30				
1/4	L66	0.119	0.38	0.53	0.65	0.75	0.84	0.92	0.99	1.06	1.13	1.19	0.066	36	18	1/4"	1.31	0.56	0.75
	L80	0.171	0.54	0.76	0.94	1.08	1.21	1.32	1.43	1.53	1.62	1.71	0.080	48	24				
	L120	0.384	1.22	1.72	2.10	2.43	2.72	2.98	3.21	3.44	3.65	3.84	0.120	60	30				

$$\text{Flow Rate (GPM)} = K \sqrt{\text{PSI}}$$

Standard Materials: Brass, 303 Stainless Steel, 316 Stainless Steel and PTFE (L40, L48, L54 not available in PTFE).

Spray angle performance varies with pressure. Contact BETE for specific data on critical applications.

UltiMist®

Misting Nozzles

DESIGN FEATURES

Metal:

- 416 Stainless Steel tip
- Brass body
- 1/8" and 1/4" sizes
- Male or female connections
- Integral 100 mesh strainer

Plastic:

- All plastic construction
- 1/8" male connection

SPRAY CHARACTERISTICS

- Very fine, fog-like mist
- Produces high number of droplets under 60 microns

Spray pattern: Hollow Cone
Medium angle

Flow rates: Metal: 0.37 - 16.4 gph
Plastic: 0.63 - 8.5 gph



Plastic Nozzle



Metal

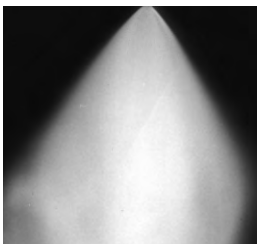

Mist

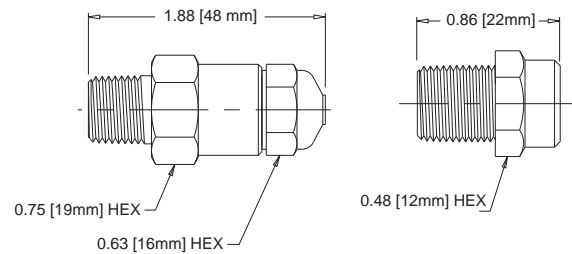

Dimensions are approximate. Check with BETE for critical dimension applications.

UltiMist Metal Flow Rates and Dimensions

Hollow Cone, Medium Spray Angle, 1/8" and 1/4" Pipe Sizes

NPT, BSP Male or Female Pipe Size	Nozzle Number	K Factor	GALLONS PER HOUR @ PSI				
			40 PSI	100 PSI	500 PSI	1000 PSI	1200 PSI
1/8	UM37M	0.059	0.37	0.59	1.3	1.9	2.0
	UM50M	0.079	0.50	0.79	1.8	2.5	2.7
	UM75M	0.119	0.75	1.2	2.7	3.8	4.1
or 1/4	UM100M	0.158	1.0	1.6	3.5	5.0	5.5
	UM150M	0.237	1.5	2.4	5.3	7.5	8.2
	UM200M	0.316	2.0	3.2	7.1	10.0	11.0
	UM250M	0.395	2.5	4.0	8.8	12.5	13.7
	UM300M	0.474	3.0	4.7	10.6	15.0	16.4

Flow Rate (GPH) = $K \sqrt{\text{PSI}}$

Standard Material: 416 Stainless Steel Tip, Brass Adapter/Body

UltiMist Plastic Flow Rates

Hollow Cone, Medium Spray Angle, 1/8" Pipe Size

NPT Male Pipe Size	Nozzle Number	K Factor	GALLONS PER HOUR @ PSI				
			40 PSI	60 PSI	100 PSI	200 PSI	1000 PSI
1/8	UML63M	0.100	0.63	0.77	1.0	1.4	3.2
	UML126M	0.200	1.3	1.5	2.0	2.8	6.3
	UML170M	0.270	1.7	2.1	2.7	3.8	8.5

Flow Rate (GPH) = $K \sqrt{\text{PSI}}$

Standard Material: Polyacetal

Spray angle performance varies with pressure. Contact BETE for specific data on critical applications.

MISTING

TO ORDER: specify pipe size, connection type, nozzle number, spray angle, and material.

SS

Small Droplet Size Dense Mist

DESIGN FEATURES

- Twelve multiple flat fan patterns
- Solid one-piece construction
- Female connection

SPRAY CHARACTERISTICS

- Multiple flat fans produce coarser spray at lower pressures and dense, far reaching mist at higher pressures
- Relatively small droplets

Spray pattern: Dense full cone

Flow rates: 2.40 to 157 gpm

Spray angles: **SS4.8** thru **SS25** - 35°
SS35 thru **SS70** - 45°



Mist

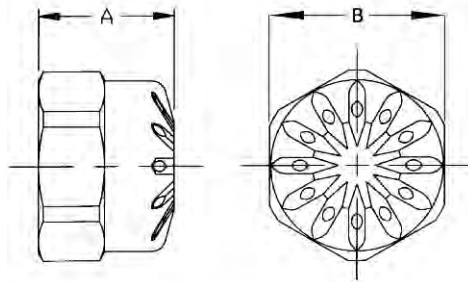

Dimensions are approximate. Check with BETE for critical dimension applications.

SS Flow Rates and Dimensions

Full Cone Mist, 3/4", 1" and 1-1/4" Pipe Size

Female Pipe Size	Nozzle Number	K Factor	GALLONS PER MINUTE @ PSI										Dimensions (in.)		Wt. (oz.)
			10 PSI	20 PSI	30 PSI	40 PSI	50 PSI	60 PSI	80 PSI	100 PSI	150 PSI	200 PSI	A	B	
3/4	SS4.8	0.759	2.40	3.39	4.16	4.80	5.37	5.88	6.79	7.59	9.3	10.7	1.0	1.25	3
	SS9	1.42	4.50	6.36	7.79	9.00	10.1	11.0	12.7	14.2	17.4	20.1			
	SS12	1.90	6.00	8.49	10.4	12.0	13.4	14.7	17.0	19.0	23.2	26.8			
	SS18	2.85	9.00	12.7	15.6	18.0	20.1	22.0	25.5	28.5	34.9	40.2			
1	SS25	3.95	12.5	17.7	21.7	25.0	28.0	30.6	35.4	39.5	48.4	55.9	1.16	1.50	5
	SS35	5.53	17.5	24.7	30.3	35.0	39.1	42.9	49.5	55.3	67.8	78.3			
1 1/4	SS50	7.91	25.0	35.4	43.3	50.0	55.9	61.2	70.7	79.1	96.8	112	1.22	1.88	8
	SS70	11.1	35.0	49.5	60.6	70.0	78.3	85.7	99.0	111	136	157			

$$\text{Flow Rate (GPM)} = K \sqrt{\text{PSI}}$$

Standard Materials: Brass, 303 and 316 Stainless Steel.

Spray angle performance varies with pressure. Contact BETE for specific data on critical applications.



MISTING

CALL 413-772-0846
Call for the name of your nearest BETE representative.

XA

Low Flow Air Atomizing

The XA nozzle system uses the energy in compressed air to produce highly atomized sprays at low flow rates. There are many interchangeable components that can be assembled to achieve a variety of spraying objectives.

SPRAY SET-UPS

XA nozzles produce eight distinctly different types of sprays, depending on which interchangeable air and fluid caps are selected. The spray type and flow rate are determined by the "set-up" — a specific combination of one air cap and one fluid cap.

Internal Mix Set-ups

Liquid and air streams meet within the nozzle and are mixed together and expelled through the same orifice(s). This internal mixing means the streams are not independent; a change in air flow will affect the liquid flow. This makes precise metering of the liquid more difficult than with an External Mix Set-up. Internal Mix Set-ups are able to produce the finest atomization of any of the XA set-ups, but they are generally not suitable for use with liquids which have a viscosity that is above 200 centipoise.

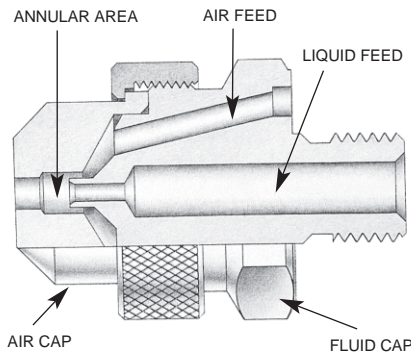

Cutaway View: Internal Mix Set-up

External Mix Set-ups

The air and liquid streams exit the nozzle independently and are combined and mixed outside of the nozzle. Because there is no connection between the air and liquid lines within the nozzle, the air and liquid flow rates can be controlled independently, allowing precise metering of the liquid. The atomization can be controlled by adjusting the air flow rate—more air produces finer atomization. In most cases these set-ups do not atomize as finely as Internal Mix Set-ups.

External Mix Set-ups may be used with liquids having a viscosity above 200 centipoise and for abrasive suspensions. BETE Applications Engineering can provide guidance for spraying high viscosity liquids.

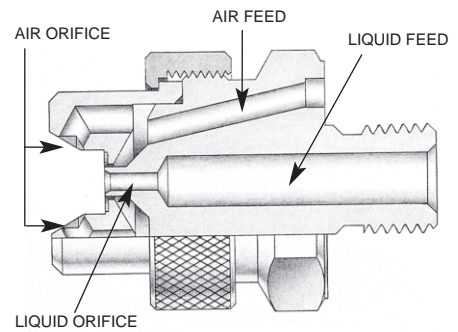

Cutaway View: External Mix Set-up

Siphon Set-ups

Internal and External Mix Set-ups require the liquid to be supplied to the nozzle under pressure from a municipal water supply, pump, or pressure vessel. Siphon Set-ups use the flow of compressed air within the nozzle to siphon liquid from a container. Siphon Set-ups are frequently used for spraying additives from a container without the use of a pump. They provide the

E. Air Operated Shut-off



A. End Plug

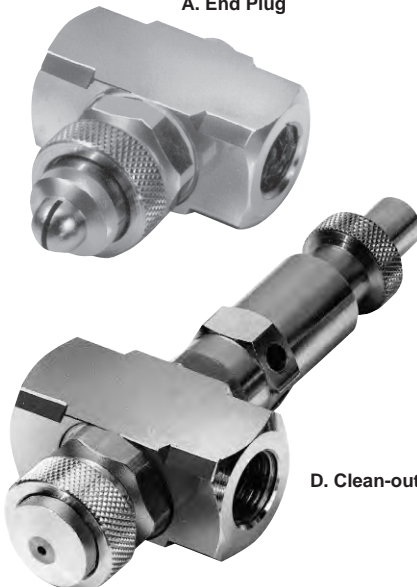

B. Shut-off

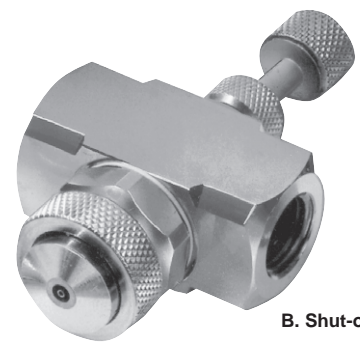

D. Clean-out/Shut-off

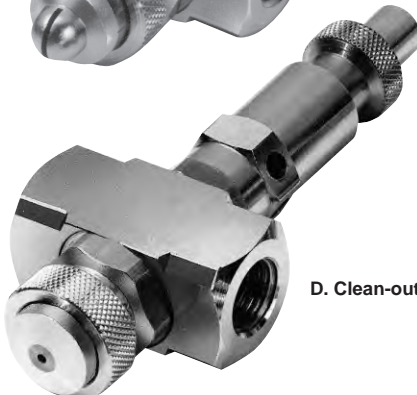

Bold letters (A, B, C, D, E, F) refer to hardware assemblies shown on p. 74.

TO ORDER: specify pipe size, body style, spray set-up #, hardware and mounting assemblies, and material. See page 74.

XA Components & Options

lowest flow rates available in the XA series (as low as 0.1 GPH). They are generally not suitable for use with liquids having a viscosity above 200 centipoise.

By supplying the liquid under pressure, SR Set-ups may be used with liquids having a viscosity above 200 centipoise. In this case, the liquid flow rate is regulated by the fluid cap, and can be determined by using the EF chart for the specific fluid cap.

BASIC OPERATION

The basic XA nozzle assembly consists of a body, a spray set-up, and a "hardware assembly" that can provide shut-off and clean-out capabilities.

Non-Automatic Operation

The XA00 Square Body is the basic component of a non-automatic XA nozzle. Air and liquid feeds are located at opposite ends, perpendicular to the spray.

The XA03 Body has air and liquid feeds on one side, perpendicular to the spray axis.

The XA05 Body has air and liquid inlets located in-line with the spray. Hardware assemblies cannot be used with the XA05 body.

Hardware Assemblies for Non-Automatic Operation

A. Plug. The minimum option hardware assembly required for XA operation. Provides neither clean-out nor shut-off.

B. Shut-off. Turning the knurled knob will stop the flow of liquid to the nozzle. Should not be used to meter the flow of liquid.

C. Clean-out. Pressing the spring-loaded plunger will force a small diameter rod through the liquid orifice, cleaning any obstruction. Useful for intermittent spraying of a liquid that may dry in the orifice when not in use.

D. Clean-out/Shut-off. Combines functions of hardware assemblies B and C in one unit.

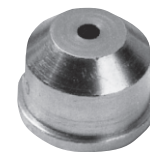

PR Air Cap



Fluid Cap



FF Air Cap



SR Air Cap



ER Air Cap

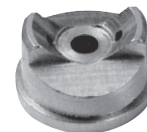

EF Air Cap



XW Air Cap



PF Air Cap

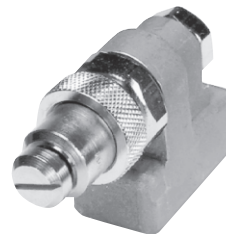

XA03 Body

XA00 Body
with C Hardware



XA05 Body

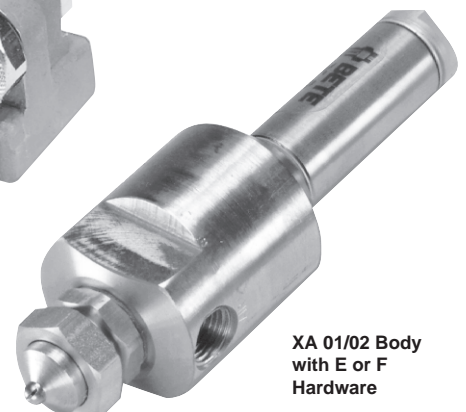

XA 01/02 Body
with E or F
Hardware

XA Components & Options

Spray Set-up

Body Styles and Seals

Hardware Assemblies

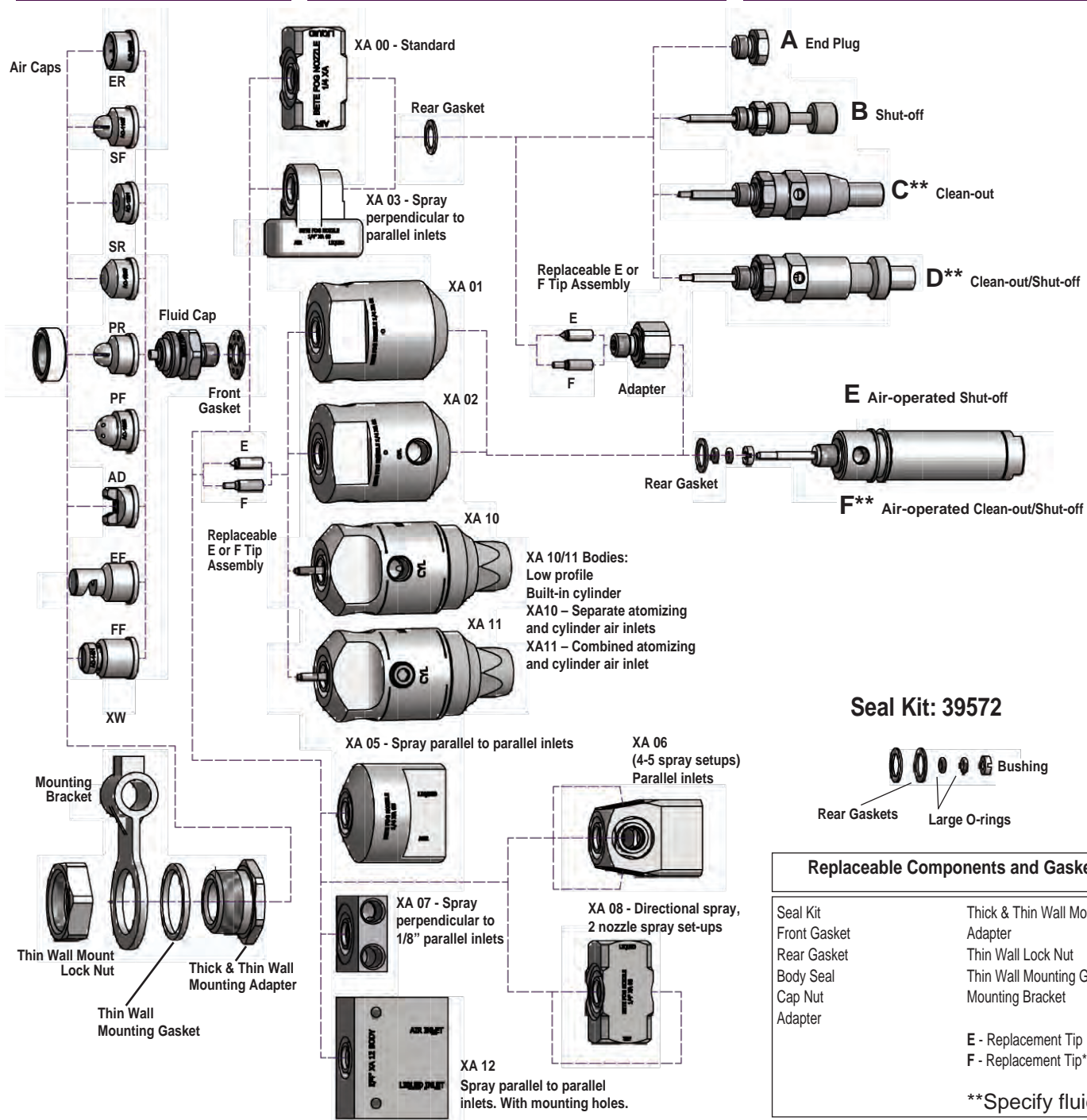

Seal Kit: 39572

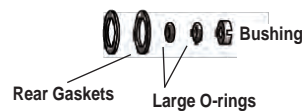

Replaceable Components and Gaskets

Seal Kit	Thick & Thin Wall Mount
Front Gasket	Adapter
Rear Gasket	Thin Wall Lock Nut
Body Seal	Thin Wall Mounting Gasket
Cap Nut	Mounting Bracket
Adapter	
	E - Replacement Tip
	F - Replacement Tip**
	**Specify fluid cap

TO ORDER

Spray Set-up Number

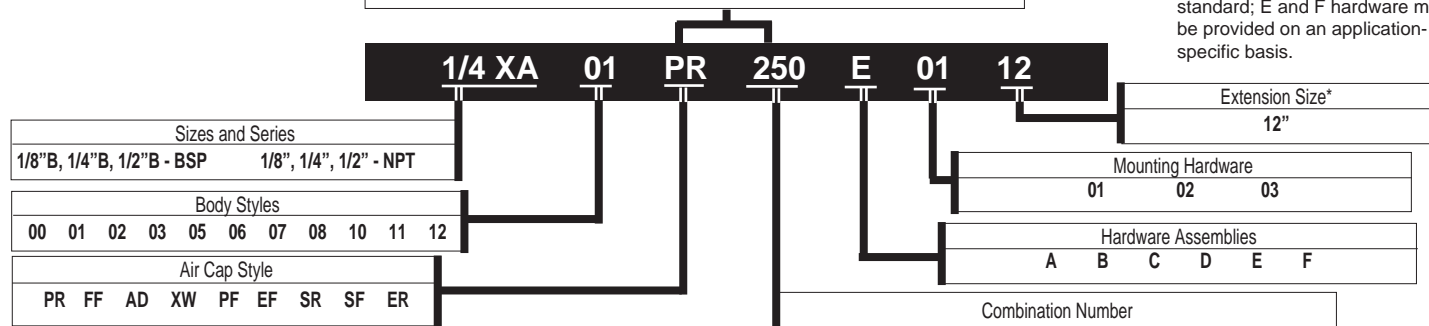

*For extensions, A hardware is standard; E and F hardware may be provided on an application-specific basis.

XA Components & Options

AUTOMATIC OPERATION

For critical applications which require automatic, no-drip, or high-speed spray shut-off, the XA can be supplied with an air cylinder operated shut-off or clean-out/shut-off. These air cylinders provide virtually instantaneous liquid shut-off at rates of up to 180 cycles per minute. *The air cylinders require a minimum of 80 PSI to run that fast.*

Bodies for Automatic Operation

The XA01, XA02, XA10, and XA11 Round Bodies are rugged, highly reliable, and well suited to the rigors of high-cycle automatic operation. They have been designed to simplify the feed piping required for installing automatic nozzles by providing a constant location for the air inlet piping. With their neat, professional appearance, they are particularly recommended for OEM applications.

The XA01 Round Body has one inlet for air and one for liquid. Because the air inlet supplies air for both cylinder movement and liquid atomization, spraying during start-up and shut-off is not as crisp and precise as with the XA02. *The XA01 body cannot be used with atomizing air pressure under 30 PSI.*

The XA02 Round Body has two inlets for air and one inlet for liquid. One of the air inlets supplies the cylinder and the other supplies atomizing air. The XA02 body

must be used when the air cylinder operates at a different pressure from the atomizing air or where the atomizing air is supplied below 30 PSI.

NOTE: The XA00 Square and XA03 Bodies used for non-automatic operation can also be used, with hardware assemblies E or F, for automatic operation. Special design features allow field upgrading to automatic operation.

The XA10 and XA11 Bodies have a built in air-operated cylinder. The integral cylinder provides a smaller profile for use where space is limited.

Hardware Assemblies for Automatic Operation

E. Air-Operated Shut-off. Removal of air pressure to the cylinder causes a spring-loaded poppet valve actuator to shut off liquid flow.

F. Air-Operated Clean-out/Shut-off. Operation similar to E, but includes a clean-out needle.

SOLENOID VALVES

Electrically operated solenoid valves can be used to control the operation of any XA nozzle. BETE can supply solenoid valves matched to your specific application.

Solenoids for Automatic XA Nozzles.

A 3-way, quick-exhaust solenoid valve is required to operate the E or F hardware assembly. The valve is

located in the line that supplies air to the cylinder, as close to the nozzle as possible. Independent control of the atomizing air of an XA02 or square body requires an additional 2-way solenoid valve.

Solenoids for Non-Automatic XA Nozzles.

Two-way solenoid valves can be used to stop and start the flow of air and liquid to any non-automatic XA nozzle.

FILTERS, REGULATORS AND STRAINERS

For optimum reliability, every pressure-fed XA nozzle should have a strainer and regulator in the liquid feed line and a filter and regulator in the air feed line. Every XA nozzle with a Siphon Feed Set-up should have a filter and regulator in the air line. The size and type of each of these components depends on the application, and can be determined by your BETE sales representative. BETE maintains an inventory of filters, strainers, and regulators that can be supplied with your XA nozzle to ensure reliable operation. These components can be purchased individually or in kit form.

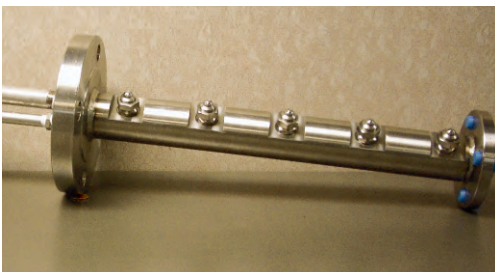

Simple piping and robust design describe this multiple nozzle XA lance.

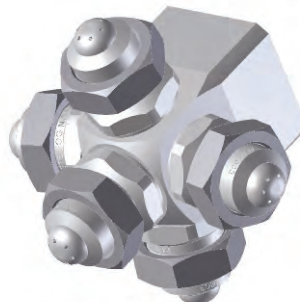

The XA06 manifold body can be fitted with up to five nozzle setups and is often used for humidification of large areas.



Corrosion-resistant XA in PVC

XA Components & Options

SPRAY EXTENSIONS

The spray set-up can be moved away from the nozzle body by using optional 6" or 12" extensions. These allow the spray to be moved closer to the target while keeping the nozzle body and associated piping at a distance.

MOUNTING HARDWARE

In many XA installations the nozzle is supported by the rigid metal pipe that supplies air or liquid. There are several components which can provide support for the XA Bodies when it isn't appropriate to suspend the nozzle from piping; for example, when the nozzle will spray through the wall of a tank or duct, or when the air and liquid will be supplied through flexible tubing. All XA bodies except the XA03 can be used with any of the mounting hardware described here.

Thin Wall 02 Adapter

Three-piece adapter used to support an XA nozzle with the body located outside a tank or duct having a relatively thin (less than 3/8") wall and the spray directed into the interior. To use this adapter, a 1-1/16" diameter hole must be drilled through the wall. This adapter both secures the air cap and attaches the nozzle body to the tank wall.

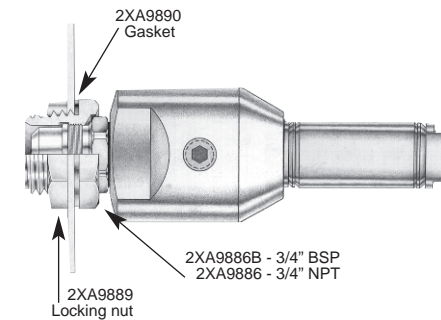

XA02 with Thin Wall 02 Adapter

Thick Wall 01 Adapter

Similar in design and function to the Thin Wall Adapter, but intended for use with tanks or ducts with walls that are thick enough (3/8" or over) to be drilled and tapped for a 3/4" NPT thread.

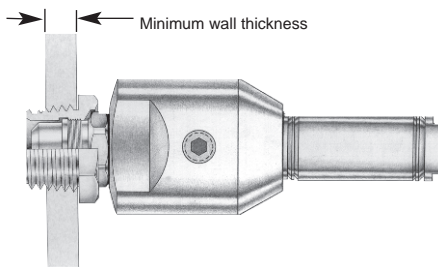

XA02 with Thick Wall 01 Adapter

Mounting Bracket 03 Adapter

This bracket is used in combination with a Thin Wall Adapter to support an XA nozzle from a 1/2"-diameter metal rod. The bracket allows flexibility in aiming the spray.

MATERIALS

Bodies, Fluid Caps, Air Caps, Hardware Assemblies, Mounting Hardware

The standard materials for the XA series are nickel-plated brass and 303 and 316 stainless steels. Other metals and plastics can be supplied on request. See page 13 for a complete material list.

Air Cylinders

The air cylinders used for XA hardware assemblies E and F have rods and cylinders made of stainless steel and end caps made of anodized aluminum. All metal parts in contact with the spray liquid are 316 stainless steel.

Seals

The standard material for XA gaskets is compressed fiber with a neoprene binder. For installations requiring FDA approval, SBR gaskets are available. Other elastomeric and metallic gasket materials can be supplied on request.

The standard material for O-rings in XA automatics is Viton®. Other materials available on request.



XA03 Mounting Bracket

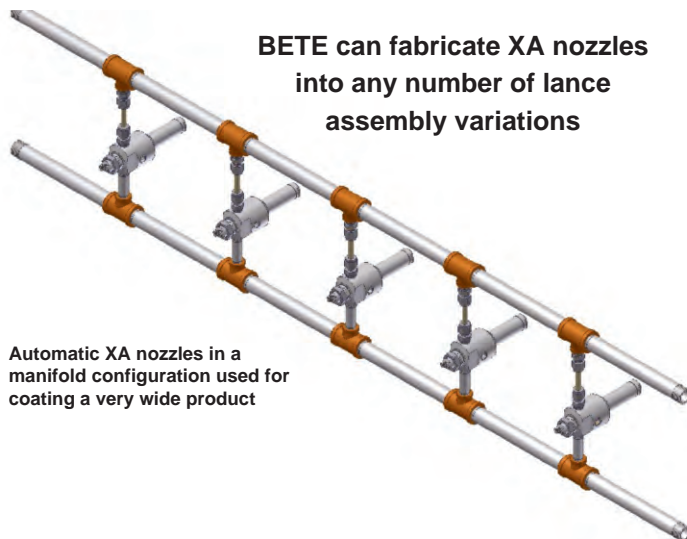

BETE can fabricate XA nozzles into any number of lance assembly variations

Automatic XA nozzles in a manifold configuration used for coating a very wide product

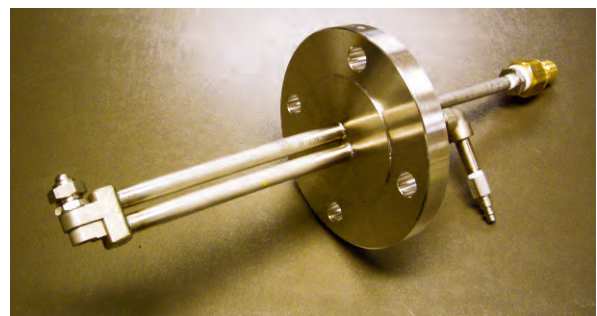

Spray lance (see pages 18,19) with a right angle XA and quick-connect fittings

XA Components & Options

Dimensions are approximate. Check with BETE for critical dimension applications.

Spray Set-up Numbers						
SPRAY SET-UP	PIPE SIZE BSP or NPT	SET-UP NO.	FLUID CAP	AIR CAP		
EF	FLAT FAN (EXTERNAL MIX)	EF 050	FC7	AC1001		
		EF 100		AC1003		
		EF 150	FC4	AC1001		
		EF 200		AC1003		
		EF 250	FC3	AC1001		
		EF 300		AC1003		
		EF 350	FC6	AC1002		
		EF 400		AC1004		
		EF 450	FC2	AC1002		
		EF 500		AC1004		
		EF 550	FC1	AC1002		
		EF 600		AC1004		
		EF 650	FC8	AC1005		
		EF 700	FC9	AC1005		
EF 750	FC5	AC1005				
	1/2	EF 5050	FC501	AC5001		
SF	SIPHON FLAT FAN	SF 050	FC3	AC1101		
		SF 100	FC6	AC1102		
		SF 150	FC2	AC1103		
	1/4	SF 200	FC2	AC1104		
SR	SIPHON ROUND	SR 050	FC7	AC1201		
		SR 150	FC4	AC1201		
		SR 200	FC4	AC1202		
		SR 250	FC3	AC1202		
		SR 400	FC1	AC1204		
		SR 450	FC5	AC1205		
	1/2	SR 5050	FC501	AC5201		
PF	PRESSURE FLAT FAN	PF 050	FC4	AC1301		
		PF 100	FC3	AC1303		
		PF 150	FC3	AC1301		
		PF 200	FC3	AC1302		
		PF 250	FC2	AC1304		
		PF 300	FC1	AC1304		
		PF 350	FC1	AC1305		
PF 400	FC5	AC1306				
XW	EXTRA WIDE-ANGLE ROUND	PF 5050	FC501	AC5301		
		PF 5100	FC502	AC5302		
		XW 050	FC8	AC1401		
	1/2	XW 5050	FC502	AC5401		
PR	PRESSURE ROUND	PR 050	FC4	AC1501		
		PR 100	FC4	AC1502		
		PR 150	FC3	AC1502		
		PR 200	FC2	AC1503		
		PR 250	FC1	AC1503		
		PR 300	FC5	AC1504		
			1/2	PR 5050	FC501	AC5501
		PR 5100	FC502	AC5502		
AD	WIDE ANGLE ROUND	AD 050	FC4	AC1601		
		AD 100	FC2	AC1603		
		AD 150	FC2	AC1602		
		AD 200	FC1	AC1603		
		AD 250	FC1	AC1604		
		AD 300	FC5	AC1605		
			1/2	AD 5050	FC501	AC5601
				AD 5100	FC501	AC5602
				AD 5150	FC501	AC5603
				AD 5200	FC502	AC5604
FF	DEFLECTED FLAT FAN	FF 050	FC10	AC1701		
ER	NARROW ANGLE ROUND	ER 050	FC7	AC1801		
		ER 150	FC4	AC1801		
		ER 250	FC3	AC1801		
		ER 350	FC6	AC1802		
		ER 450	FC2	AC1802		
		ER 550	FC1	AC1802		
		ER 650	FC3	AC1803		
		ER 750	FC9	AC1803		
ER 850	FC5	AC1803				

Dimensions with Hardware Options for XA00 Body, BSP or NPT

Pipe Size	Hardware Option	Dimensions in inches			
		W	X	Y	Max. "Z"
1/8 OR 1/4	A				9/16
	B				1 5/8
	C	7/8	1 11/16	1 15/16	2 5/8
	D				3 3/16
	E				4 1/16
	F				4 1/16
1/2	A	1 1/4	2 1/2	2 11/16	1

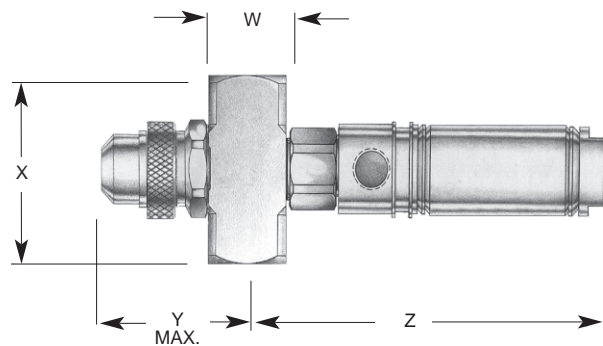

Overall Dimensions of XA Assemblies with XA00 Body (Shown with E or F Hardware)

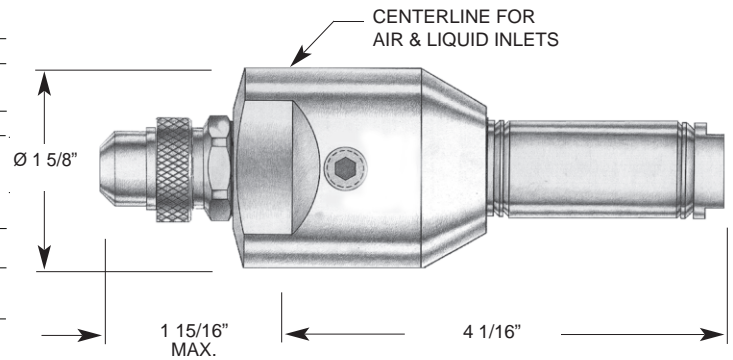

Overall Dimensions for Assemblies with XA01 or XA02 Bodies

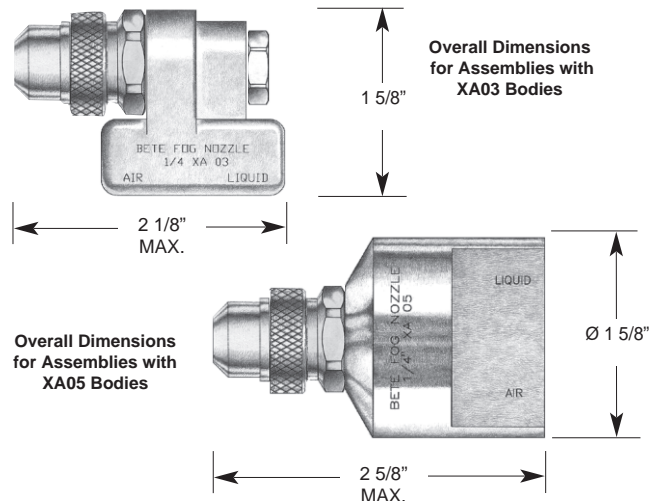

Overall Dimensions for Assemblies with XA05 Bodies

AIR ATOMIZING

CALL 413-772-0846
Call for the name of your nearest BETE representative.

XA Components & Options

SYSTEM SET-UPS AND ACCESSORIES

BETE carries a complete line of controls and accessories required for setting up a system using the XA Series nozzles.

Contact your BETE representative for details.

Pressure System Set-up

In a pressure-fed system, the liquid is supplied under pressure to either internal or external mix BETE XA Series nozzles.

Air and liquid regulators control the fluid delivery pressure, while the air filter and liquid strainer ensure that the supplied fluids are free of particulate.

Operational control is maintained by manual or solenoid valves used in conjunction with the various hardware assemblies.

Siphon System Set-up

In a siphon-fed system, the liquid is supplied by either a siphon or gravity feed.

An air regulator controls the air delivery pressure, while the air filter ensures that the compressed air is of high quality.

Operational control is maintained by manual or solenoid valves used in conjunction with the various hardware assemblies.

When used as a gravity feed set-up, a positive liquid shutoff capability should be provided.

Filters, regulators, and strainers matched to your XA application are available from stock.

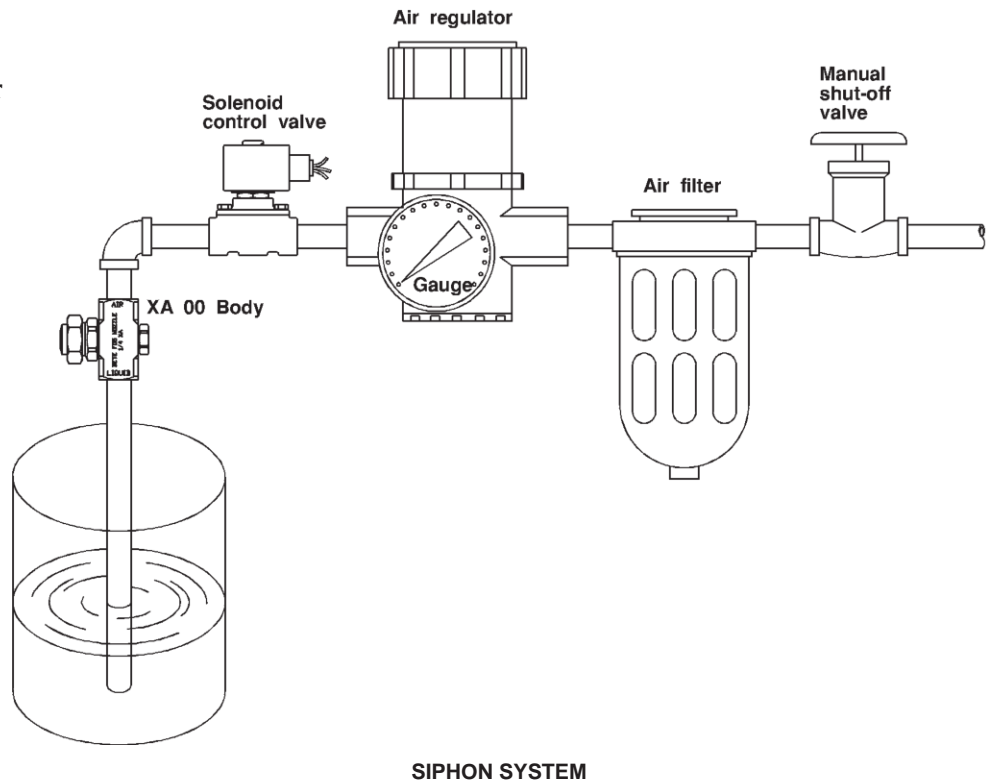
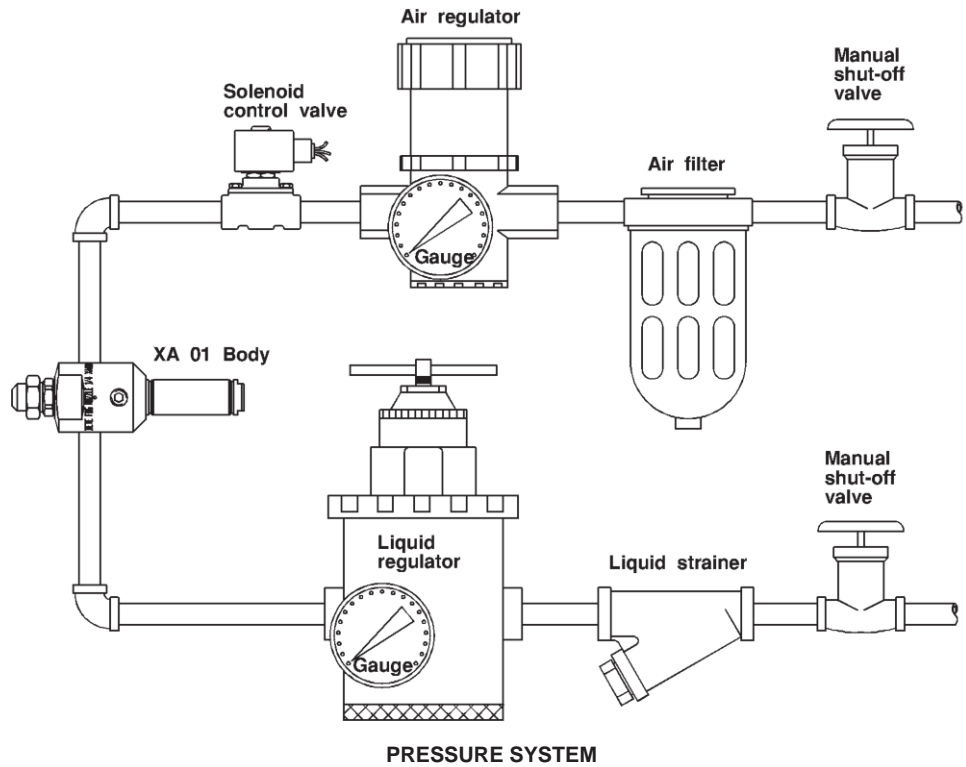

AIR ATOMIZING

TO ORDER: specify pipe size, body style, spray set-up #, hardware and mounting assemblies, and material. See page 74.

XAAD

Pressure-fed/Int. Mix/Wide Angle Round

DESIGN/SPRAY CHARACTERISTICS

- Internal mix
- 70° Hollow Cone spray pattern
- Finest atomization
- Moderate forward spray projection

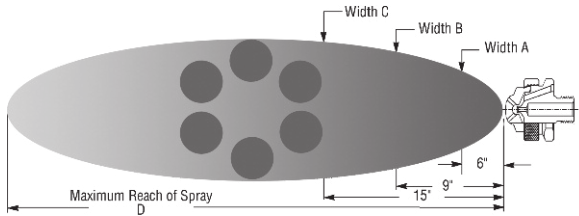

Dimensions are approximate. Check with BETE for critical dimension applications.

XA AD Set-up Flow Rates and Dimensions

Pressure Fed, Internal Mix, Wide Angle Round Spray Pattern, 1/8" and 1/4" Pipe Sizes

Pipe Size	Spray Set-up Number	Fluid and Air Cap Numbers	10 PSI Liquid			20 PSI Liquid			30 PSI Liquid			40 PSI Liquid			60 PSI Liquid			Spray Dimensions										
			PSI air	GPH	SCFM	PSI air	GPH	SCFM	PSI air	GPH	SCFM	PSI air	GPH	SCFM	PSI air	GPH	SCFM	PSI air	PSI liquid	"A" in.	"B" in.	"C" in.	"D" feet					
1/8 or 1/4	AD 050	Fluid Cap FC4 & Air Cap AC1601	8	1.4	0.4	14	2.1	0.4	22	2.4	0.6	30	2.5	0.7	44	3.0	0.8											
			10	1.1	0.4	16	1.9	0.5	26	2.0	0.7	34	2.2	0.8	48	2.7	0.9	10	10	6	7	9	5'0"					
			12	0.8	0.5	18	1.7	0.6	30	1.6	0.8	38	1.9	0.9	55	2.3	1.2	20	20	6	8	10	6'0"					
			14	0.5	0.6	20	1.4	0.6	34	1.2	1.0	42	1.5	1.1	60	1.9	1.4	34	30	7	8	10	7'0"					
						22	1.2	0.7	36	0.9	1.1	46	1.1	1.3	65	1.5	1.6	42	40	7	8	11	9'0"					
						24	0.9	0.8	38	0.7	1.2	48	0.9	1.4	70	1.1	1.8	60	60	8	9	12	12'0"					
				26	0.6	0.9	40	0.4	1.3	50	0.7	1.5	75	0.7	2.1													
		AD 100	Fluid Cap FC2 & Air Cap AC1603	12	1.9	1.8	22	3.3	2.3	30	5.1	2.5	38	6.4	2.8	54	8.8	3.4										
	14			0.6	2.2	24	2.2	2.8	32	4.3	2.9	42	4.7	3.4	56	8.1	3.7	12	10	7	10	13	6'0"					
						26		3.1	34	3.4	3.2	44	3.9	3.7	58	7.4	4.0	24	20	8	10	13	8'0"					
						36	2.5	3.5	46	3.1	4.1	60	6.8	4.3	60	6.8	4.3	34	30	8	10	13	10'0"					
						38	1.6	3.9	48	2.3	4.4	65	5.1	5.1	46	5.1	5.1	46	40	8	11	14	13'0"					
						40	0.7	4.3	50	1.4	4.8	70	3.5	6.0	70	3.5	6.0	60	60	9	11	15	16'0"					
		AD 150	Fluid Cap FC2 & Air Cap AC1602	16	3.2	1.4	28	4.6	2.0	42	5.3	2.7	55	5.7	3.3	80	7.1	4.5										
	18			2.6	1.6	32	3.4	2.3	46	4.0	3.0	60	4.2	3.7	85	5.8	4.9	22	10	6	8	9	9'0"					
	20			2.1	1.8	36	2.5	2.6	48	3.5	3.1	65	3.2	4.1	90	4.7	5.3	40	20	7	8	10	15'0"					
	22			1.6	1.9	40	1.8	2.9	50	3.0	3.3	70	2.3	4.4	95	3.8	5.7	50	30	7	8	10	18'0"					
	24			1.3	2.1	42	1.5	3.0	55	2.1	3.6	75	1.7	4.8	100	3.0	6.0	70	40	7	9	10	22'0"					
	26			1.0	2.2	44	1.2	3.1	60	1.5	4.0	80	1.3	5.2				90	60	8	10	11	26'0"					
		AD 200	Fluid Cap FC1 & Air Cap AC1603	10	6.3	1.1	20	9.0	1.6	30	11.2	2.0	40	12.4	2.5	56	16.2	2.8										
	12			3.6	1.5	22	6.9	2.0	32	9.3	2.4	42	10.6	2.9	58	14.8	3.1	12	10	8	10	14	7'0"					
	14			2.0	2.0	24	5.1	2.4	34	7.4	2.8	44	8.8	3.3	60	13.8	3.5	22	20	8	11	15	10'0"					
						26	3.3	2.8	36	5.4	3.2	46	7.1	3.7	65	9.8	4.4	34	30	8	11	15	12'0"					
						38	3.6	3.6	48	5.4	4.1	70	6.5	5.4	46	6.5	5.4	46	40	8	11	15	15'0"					
					40	2.3	4.0	50	3.6	4.5	75	4.0	6.3	65	4.0	6.3	60	60	8	11	16	19'0"						
	AD 250	Fluid Cap FC1 & Air Cap AC1604	18	9.4	3.0	30	13.4	4.2	44	15.3	5.5	60	15.6	7.1	80	21.4	8.6											
22			7.7	3.6	34	11.9	4.7	48	13.8	5.9	70	12.5	8.3	85	19.5	9.2	28	10	8	10	13	18'0"						
26			6.0	4.1	38	10.3	5.1	55	11.3	6.8	80	9.3	9.5	90	17.9	9.8	42	20	8	11	14	21'0"						
28			5.2	4.4	42	8.9	5.6	65	7.8	8.0	85	7.8	10.1	95	16.5	10.4	65	30	9	11	15	22'0"						
30			4.4	4.7	46	7.3	6.1	70	6.1	8.6	90	6.2	10.7	100	15.1	11.0	85	40	9	12	15	24'0"						
32			3.7	5.0	50	5.8	6.7	75	4.5	9.3	95	4.8	11.3				90	60	10	13	16	28'0"						
	AD 300	Fluid Cap FC5 & Air Cap AC1605	24	6.7	5.5	38	10.7	7.4	48	16.5	8.8	60	18.6	10.4	85	29.2	13.7											
26			5.2	5.9	42	7.6	8.3	52	12.5	9.6	65	13.7	11.4	90	24.6	14.7	28	10	10	13	18	18'0"						
28			4.0	6.3	44	6.2	8.7	56	9.2	10.4	70	10.0	12.4	95	20.7	15.8	46	20	10	14	19	20'0"						
30			3.0	6.8	46	5.0	9.1	60	6.6	11.3	75	7.4	13.5	100	17.5	16.9	60	30	11	15	20	24'0"						
					48	4.0	9.5	62	5.6	11.7	80	5.5	14.5				75	40	12	15	21	26'0"						
					50	3.0	9.9	65	4.4	12.3	85	4.0	15.5				90	60	13	17	23	28'0"						
			52	2.4	10.3	70	2.6	13.3	90	2.5	16.6																	

Standard Materials: Nickel Plated Brass, 303 Stainless Steel and 316 Stainless Steel.

Spray angle performance varies with pressure. Contact BETE for specific data on critical applications.

XAPR

Pressure-fed/Int. Mix/Narrow Angle Round

DESIGN/SPRAY CHARACTERISTICS

- Internal mix
- Full cone pattern
- Finest atomization
- Large forward projection (up to 28 feet)
- Narrow spray angle (12° - 22°)

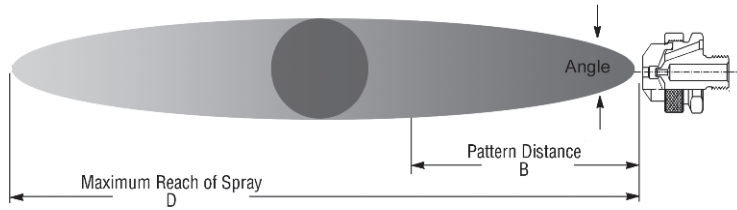

Dimensions are approximate. Check with BETE for critical dimension applications.

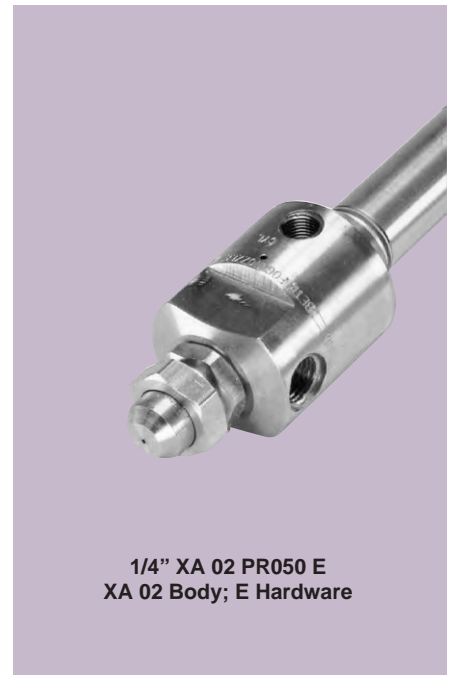

1/4" XA 02 PR050 E
XA 02 Body; E Hardware

AIR ATOMIZING

XA PR Set-up Flow Rates and Dimensions

Pressure-fed, Internal Mix, Round Spray Pattern, 1/8" and 1/4" Pipe Sizes

Pipe Size	Spray Set-up Number	Fluid and Air Cap Numbers	10 PSI Liquid			20 PSI Liquid			30 PSI Liquid			40 PSI Liquid			60 PSI Liquid			Spray Dimensions				
			PSI air	GPH	SCFM	PSI air	GPH	SCFM	PSI air	GPH	SCFM	PSI air	GPH	SCFM	PSI air	GPH	SCFM	PSI air	liquid	Angle deg.	"B" in.	"D" feet
1/8	PR 050	Fluid Cap FC4 & Air Cap AC1501	10	0.7	0.6	14	1.5	0.4	24	1.7	0.6	32	1.9	0.7	50	2.3	1.0	12	10	13	12	9'0"
			12	0.5	0.7	18	1.2	0.5	28	1.4	0.6	36	1.6	0.8	54	2.1	1.1	14	14	14	14	11'0"
			14	0.4	0.8	22	1.0	0.6	32	1.1	0.8	40	1.3	0.9	58	1.8	1.2	24	20	13	13	10'0"
			24	0.9	0.7	36	0.8	1.0	44	1.1	1.1	62	1.6	1.4	36	30	13	14	16	12'0"		
			26	0.7	0.8	38	0.7	1.0	48	0.9	1.2	66	1.3	1.5	44	40	14	16	12'0"			
			28	0.6	0.8	40	0.7	1.1	50	0.7	1.3	68	1.2	1.6	62	60	15	18	14'0"			
	30	0.5	0.9	42	0.5	1.2	52	0.7	1.4	70	1.1	1.7										
	PR 100	Fluid Cap FC4 & Air Cap AC1502	10	0.7	0.7	18	1.4	0.9	24	2.0	1.0	30	2.4	1.1	40	3.3	1.4	12	10	12	17	12'0"
			12	0.5	0.8	20	1.3	1.0	28	1.7	1.2	34	2.2	1.3	46	2.9	1.5	20	20	13	18	13'0"
			14	0.4	0.9	22	1.2	1.1	32	1.4	1.4	38	1.9	1.5	52	2.6	1.8	20	20	13	18	14'0"
			24	1.1	1.2	34	1.3	1.5	42	1.6	1.7	58	2.3	2.1	34	30	13	19	14'0"			
			26	0.9	1.3	36	1.2	1.6	44	1.5	1.8	62	2.1	2.3	42	40	13	20	15'0"			
38			1.1	1.7	46	1.1	1.7	46	1.4	1.9	66	1.9	2.5	58	60	15	22	17'0"				
1/4	PR 150	Fluid Cap FC3 & Air Cap AC1502	12	1.3	0.7	22	2.2	1.1	30	2.9	1.2	36	4.3	1.3	48	5.8	1.5	22	10	12	19	13'0"
			16	1.1	0.9	26	1.7	1.3	34	2.5	1.4	40	3.9	1.4	52	5.3	1.7	34	20	13	20	14'0"
			20	0.9	1.2	30	1.4	1.5	38	2.1	1.7	44	3.6	1.6	56	4.9	1.7	34	20	13	20	14'0"
			22	0.8	1.3	34	1.3	1.7	42	1.7	1.9	48	2.8	1.8	60	4.6	1.9	42	30	13	21	15'0"
			24	0.8	1.4	38	1.1	1.9	46	1.5	2.0	52	2.5	2.0	64	4.1	2.1	48	40	14	22	16'0"
			26	0.8	1.4	40	1.0	2.0	50	1.2	2.3	56	2.2	2.2	68	3.7	2.3	60	60	15	24	17'0"
	28	0.8	1.6	42	0.9	2.0	52	1.2	2.4	60	1.8	2.4	70	3.6	2.3							
	PR 200	Fluid Cap FC2 & Air Cap AC1503	16	3.4	2.7	28	5.0	3.7	40	6.1	4.7	48	7.8	5.3	65	10.7	6.7	24	10	18	26	16'0"
			20	2.4	3.2	32	3.7	4.2	44	5.0	5.2	55	6.0	6.1	75	8.7	7.7	40	20	20	30	20'0"
			22	1.9	3.5	36	2.6	4.7	48	4.0	5.7	65	3.6	7.3	80	7.7	8.3	40	20	20	30	20'0"
			24	1.5	3.7	40	1.9	5.1	55	2.3	6.5	75	2.0	8.5	85	6.7	8.8	55	30	20	32	22'0"
			26	1.2	4.0	44	1.3	5.6	60	1.6	7.1	80	1.4	9.1	90	5.6	9.4	75	40	21	36	26'0"
28			1.0	4.2	48	0.9	6.1	65	1.1	7.8	85	1.0	9.7	95	4.6	10.0	85	60	21	38	28'0"	
30	0.7	4.5	50	0.8	6.4	70	0.7	8.4	90	0.7	10.3	100	3.6	10.6								
PR 250	Fluid Cap FC1 & Air Cap AC1503	12	8.1	2.0	20	13.6	2.6	30	16.3	3.3	38	19.5	3.7	54	25.7	4.7	14	10	17	24	16'0"	
		14	6.6	2.3	22	12.0	2.9	34	13.1	3.8	42	16.5	4.2	60	21.8	5.3	26	20	18	27	18'0"	
		16	4.9	2.7	24	10.2	3.2	38	9.9	4.3	46	13.6	4.7	65	18.5	6.0	40	30	20	30	22'0"	
		18	3.4	3.0	26	8.6	3.5	40	8.7	4.6	50	10.8	5.3	70	15.2	6.7	40	30	20	30	22'0"	
		28	7.2	3.8	42	7.6	4.9	52	9.6	5.6	75	12.2	7.8	50	40	20	31	23'0"				
		30	5.9	4.1	44	6.6	5.2	44	6.6	5.2	54	8.6	5.9	80	10.0	8.1	70	60	21	36	25'0"	
32	4.6	4.4	46	5.6	5.5	46	5.6	5.5	56	7.6	6.1	85	8.0	8.9								
PR 300	Fluid Cap FC5 & Air Cap AC1504	14	11.7	3.1	20	27.5	3.0	28	36.6	3.6	32	49.4	3.3	42	70.6	3.2	14	10	19	35	20'0"	
		16	8.5	3.6	22	23.0	3.5	30	32.6	4.0	36	42.2	4.1	46	65.0	3.9	24	20	20	39	23'0"	
		24	18.0	4.0	32	28.7	4.4	40	35.1	4.9	50	59.0	4.6	54	53.2	5.4	34	30	21	41	25'0"	
		26	14.4	4.4	34	24.8	4.8	44	28.0	5.7	54	53.2	5.4	54	53.2	5.4	34	30	21	41	25'0"	
		28	11.3	4.9	36	20.9	5.2	46	24.5	6.1	58	47.4	6.2	44	40	21	42	26'0"				
		38	17.5	5.6	48	17.5	5.6	48	21.0	6.5	65	37.8	7.5	54	60	22	46	28'0"				
40	14.6	6.0	50	18.4	6.9	70	30.0	8.6														

Standard Materials: Nickel Plated Brass, 303 Stainless Steel and 316 Stainless Steel.

Spray angle performance varies with pressure. Contact BETE for specific data on critical applications.

TO ORDER: specify pipe size, body style, spray set-up #, hardware and mounting assemblies, and material. See page 74.

XAPF

Pressure-fed/Internal Mix/Flat Fan

DESIGN/SPRAY CHARACTERISTICS

- Internal mix
- Flat fan, wide angle spray patterns (between 80° and 90°)
- Finest atomization

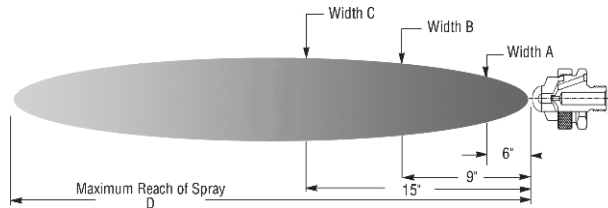

Dimensions are approximate. Check with BETE for critical dimension applications.

XA PF Set-up Flow Rates and Dimensions

Pressure-fed, Internal Mix, Flat Spray Pattern, 1/8" and 1/4" Pipe Sizes, BSP or NPT

Pipe Size	Spray Set-up Number	Fluid and Air Cap Numbers	10 PSI Liquid			20 PSI Liquid			30 PSI Liquid			40 PSI Liquid			60 PSI Liquid			Spray Dimensions						
			PSI air	GPH	SCFM	PSI air	GPH	SCFM	PSI air	GPH	SCFM	PSI air	GPH	SCFM	PSI air	GPH	SCFM	PSI air	liquid	A (in.)	B (in.)	C (in.)	D (feet)	
1/8 OR 1/4	PF 050	Fluid Cap FC4 & Air Cap AC1301	10	1.4	0.8	18	2.2	1.5	28	2.5	1.5	38	2.8	1.8	55	3.4	2.4	16	10	10	14	18	8	
			12	1.3	1.0	22	1.8	1.6	32	2.2	1.6	42	2.5	2.0	65	2.8	2.9	30	20	14	20	26	9	
			14	1.1	1.1	26	1.5	1.8	36	1.9	1.8	46	2.2	2.2	75	2.3	3.3	40	30	14	20	30	10	
			16	0.9	1.2	30	1.2	2.0	40	1.6	2.0	50	1.9	2.4	85	1.7	3.7	50	40	18	24	34	11	
			18	0.8	1.3	34	0.9	2.2	44	1.3	2.2	60	1.3	2.8	90	1.4	3.9	60	50	16	22	28	36	13
			20	0.7	1.4	38	0.7	2.4	48	1.0	2.4	65	0.9	3.0	95	1.1	4.1	70	60	14	20	26	32	14
	22	0.5	1.6	40	0.6	2.7	55	0.7	2.7	70	0.7	3.3	100	0.9	4.3	85	60	12	16	20	24	12		
	PF 100	Fluid Cap FC3 & Air Cap AC1303	20	0.8	1.2	34	1.1	1.6	44	1.8	1.9	60	1.6	2.4	80	2.7	2.9	22	10	10	14	18	6	
			22	0.6	1.3	36	0.9	1.7	46	1.6	1.9	65	1.2	2.6	85	2.2	3.1	38	20	14	20	28	6	
			24	0.5	1.4	38	0.7	1.8	48	1.4	2.0	70	0.8	2.9	90	1.8	3.4	46	30	14	20	28	7	
			26	0.4	1.5	40	0.6	1.9	50	1.1	2.1	80	0.7	3.1	100	1.5	3.6	60	40	14	20	28	7	
	28	0.3	1.6	42	0.5	2.0	55	0.7	2.4	70	0.7	3.3	100	0.9	4.3	80	60	12	16	20	24	12		
	PF 150	Fluid Cap FC3 & Air Cap AC1301	12	2.2	0.7	20	3.4	1.0	30	4.0	1.3	38	4.7	1.5	65	4.8	2.4	16	10	14	18	28	7	
			14	1.8	0.8	24	2.7	1.1	34	3.4	1.5	42	4.1	1.7	70	4.2	2.6	30	20	16	24	32	8	
			16	1.5	1.0	28	2.1	1.3	38	2.9	1.6	46	3.6	1.9	75	3.6	2.9	40	30	14	20	28	8	
			18	1.1	1.1	30	1.8	1.5	42	2.3	1.9	50	3.1	2.1	80	3.1	3.1	42	30	20	26	35	8	
	PF 200	Fluid Cap FC3 & Air Cap AC1302	20	0.8	1.2	32	1.4	1.6	46	1.7	2.1	60	1.8	2.6	85	2.5	3.4	50	40	22	28	38	9	
			34	1.2	1.7	48	1.4	2.2	65	1.2	2.8	90	2.0	3.6	80	60	23	30	38	10	14	16	10	
			36	0.9	1.8	50	1.2	2.3	70	0.8	3.1	95	1.6	3.9	100	1.5	4.2	75	60	18	24	30	12	
			40	0.7	2.0	55	0.9	2.4	60	0.7	2.7	80	0.7	3.3	100	0.9	4.3	85	60	14	20	26	32	14
	PF 250	Fluid Cap FC2 & Air Cap AC1304	16	3.0	1.9	28	4.5	2.7	38	5.9	3.2	46	7.5	3.7	65	9.7	4.8	20	10	6	7	8	9	
			18	2.3	2.1	30	3.9	2.8	40	5.4	3.4	50	6.5	4.0	70	8.6	5.2	20	9	11	12	10	10	
			20	1.7	2.3	32	3.3	3.0	42	4.9	3.6	52	5.9	4.2	72	8.0	5.6	32	20	9	11	12	10	
			24	1.3	2.5	34	2.8	3.2	44	4.3	3.7	54	5.4	4.3	80	6.4	6.0	42	30	10	13	18	11	
PF 300	Fluid Cap FC1 & Air Cap AC1304	16	3.0	1.9	28	4.5	2.7	38	5.9	3.2	46	7.5	3.7	65	9.7	4.8	20	10	6	7	8	9		
		18	2.3	2.1	30	3.9	2.8	40	5.4	3.4	50	6.5	4.0	70	8.6	5.2	32	20	9	11	12	10		
		20	1.7	2.3	32	3.3	3.0	42	4.9	3.6	52	5.9	4.2	72	8.0	5.6	32	20	9	11	12	10		
		24	1.3	2.5	34	2.8	3.2	44	4.3	3.7	54	5.4	4.3	80	6.4	6.0	42	30	10	13	18	11		
PF 350	Fluid Cap FC1 & Air Cap AC1305	14	4.5	0.8	24	7.5	1.2	34	9.5	1.7	44	11.1	2.2	56	19.8	2.6	16	10	4	5	6	8		
		16	2.9	1.0	26	6.0	1.4	36	7.8	2.0	46	9.7	2.5	60	16.7	3.0	30	20	4	5	7	10		
		18	2.0	1.2	28	4.5	1.7	38	6.5	2.2	48	8.4	2.7	65	13.5	3.5	30	20	4	5	7	10		
		20	0.8	1.4	30	3.4	1.8	40	5.2	2.5	52	5.7	3.3	70	9.7	4.3	40	30	5	7	9	11		
PF 400	Fluid Cap FC5 & Air Cap AC1306	14	7.7	3.2	26	10.5	4.6	34	20.8	4.8	42	29.4	5.2	58	44.7	6.1	14	10	7	8	10	11		
		16	5.0	3.8	28	7.0	5.2	36	16.6	5.3	44	25.1	5.6	60	41.0	6.4	14	10	7	8	10	11		
		18	3.2	4.2	30	5.1	5.6	38	12.8	5.8	46	20.8	6.1	65	31.4	7.5	26	20	10	12	16	12		
		20	2.3	4.6	32	4.2	6.0	40	9.5	6.4	48	16.7	6.6	70	22.5	8.8	38	30	10	12	18	14		

Standard Materials: Nickel Plated Brass, 303 Stainless Steel and 316 Stainless Steel.

Spray angle performance varies with pressure. Contact BETE for specific data on critical applications.

XASR

Siphon-fed Round

DESIGN FEATURES

- Lowest flow available
- Very fine atomization
- Narrow spray angle (12°- 22°)
- Full cone pattern
- Short to moderate forward spray projection

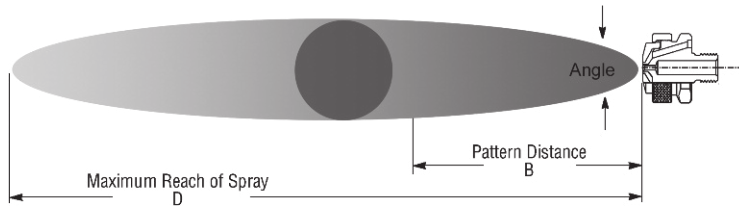

Dimensions are approximate. Check with BETE for critical dimension applications.



1/4" XASR 200 B
XA 00 Body; B Hardware

AIR ATOMIZING

TO ORDER: specify pipe size, body style, spray set-up #, hardware and mounting assemblies, and material. See page 74.

XA SR Set-up Flow Rates and Dimensions

Siphon-fed, External Mix, Round Spray Pattern, 1/8" and 1/4" Pipe Sizes

Pipe Size	Spray Set-up Number	Fluid and Air Cap Numbers	ATOMIZING AIR		Liquid Capacity in GPH (Gallons Per Hour)								Spray Dimensions at 8" Siphon Height				
			PSI air	Air Capacity SCFM	Gravity Head			Siphon Height					PSI air	Angle deg.	B in.	D feet	
					18"	12"	6"	4"	8"	12"	24"	36"					
1/8 or 1/4	SR 050	Fluid Cap FC7 & Air Cap AC1201	10	0.4	0.4	0.4	0.3	0.2	0.2	0.1				10	18	11	6
			20	0.6	0.5	0.4	0.4	0.3	0.3	0.3	0.1			20	18	11	6
			40	1.0	0.5	0.5	0.5	0.4	0.4	0.4	0.3	0.2		40	18	12	7
			60	1.3	0.6	0.5	0.5	0.4	0.4	0.4	0.3	0.2		60	18	14	8
	SR 150	Fluid Cap FC4 & Air Cap AC1201	10	0.5	0.6	0.6	0.5	0.4	0.3	0.2				10	18	12	7
			20	0.7	0.7	0.7	0.6	0.5	0.5	0.4	0.2	0.1		20	18	13	8
			40	1.1	0.9	0.8	0.8	0.7	0.7	0.6	0.4	0.3		40	18	15	9
			60	1.5	1.0	0.9	0.9	0.8	0.8	0.7	0.6	0.4		60	19	17	10
	SR 200	Fluid Cap FC4 & Air Cap AC1202	10	0.8	0.7	0.6	0.5	0.4	0.4	0.3				10	18	12	8
			20	1.2	0.8	0.7	0.6	0.6	0.5	0.4	0.2			20	18	13	9
			40	1.9	0.9	0.9	0.8	0.8	0.7	0.7	0.5	0.3		40	19	15	11
			60	2.7	1.0	1.0	0.9	0.9	0.9	0.8	0.7	0.6		60	20	17	12
SR 250	Fluid Cap FC3 & Air Cap AC1202	10	0.7	1.2	1.1	0.9	0.6	0.5	0.4				10	21	15	10	
		20	1.0	1.4	1.3	1.1	0.9	0.8	0.7	0.5			20	21	16	11	
		40	1.7	1.6	1.5	1.3	1.2	1.1	0.9	0.6	0.3		40	21	18	12	
		60	2.4	1.5	1.4	1.3	1.1	1.0	0.9	0.7	0.5		60	22	20	14	
SR 400	Fluid Cap FC1 & Air Cap AC1204	20	1.9	5.8	5.2	4.2	3.1	2.7	1.9	0.6			20	17	18	12	
		40	3.0	6.5	6.0	5.1	4.3	3.7	3.0	1.7	0.7		40	18	20	13	
		60	4.1	6.8	6.4	5.6	4.9	4.2	3.5	2.2	1.3		60	18	21	15	
		80	5.2	6.8	6.4	5.8	5.2	4.5	3.9	2.6	1.6		80	19	23	16	
SR 450	Fluid Cap FC5 & Air Cap AC1205	30	5.3				7.2	6.0	4.6				30	20	20	22	
		40	6.5				7.8	6.8	5.3				40	20	21	23	
		60	8.8				8.3	7.4	6.2	3.2			60	21	23	25	
		80	11.1	11.6	11.4	10.6	8.3	7.5	6.4	3.6	2.2		80	22	25	27	

Standard Materials: Nickel Plated Brass, 303 Stainless Steel and 316 Stainless Steel.

Spray angle performance varies with pressure. Contact BETE for specific data on critical applications.

XASF

Siphon-fed Flat Fan

DESIGN/SPRAY CHARACTERISTICS

- Lowest flow available
- Very fine atomization
- Flat fan spray pattern
- Moderate spray angle (60° - 85°)
- Moderate forward projection
- Siphon-fed

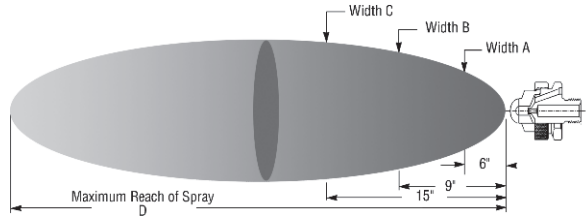

Dimensions are approximate. Check with BETE for critical dimension applications.

XA SF Set-up Flow Rates and Dimensions

Siphon-fed, Internal Mix, Flat Fan Spray Pattern, 1/8" and 1/4" Pipe Sizes

Pipe Size	Spray Set-up Number	Fluid and Air Cap Numbers	ATOMIZING AIR		Liquid Capacity in GPH (Gallons Per Hour)								Spray Dimensions at 8" Siphon Height					
			PSI air	Air Capacity SCFM	Gravity Head				Siphon Height				PSI air	"A" in	"B" in.	"C" in	"D" feet	
					18"	12"	6"	4"	8"	12"	24"	36"						
1/8 or 1/4	SF 050	Fluid Cap FC3 & Air Cap AC1101	10	1.0	0.4	0.3	0.3	0.3	0.3	0.3	0.2	0.2	0.1	10	8	11	15	7'0"
			20	1.4	0.3	0.3	0.3	0.3	0.3	0.3	0.2	0.2	0.2	20	9	12	15	7'0"
			30	1.8	0.2	0.2	0.2	0.1	0.1	0.2	0.2	0.2	0.2	30	9	12	15	6'0"
	SF 100	Fluid Cap FC6 & Air Cap AC1102	20	1.9	1.0	1.0	0.9	0.8	0.7	0.7	0.7	0.6	0.6	20	9	13	15	8'0"
			30	2.4	0.9	0.8	0.8	0.8	0.7	0.7	0.7	0.6	0.6	30	10	14	17	9'0"
			40	3.0	0.8	0.7	0.7	0.7	0.6	0.6	0.6	0.5	0.5	40	11	15	18	10'0"
	SF 150	Fluid Cap FC2 & Air Cap AC1103	20	2.3	1.4	1.3	1.2	1.0	1.0	0.9	0.8	0.6	0.6	20	8	9	11	10'0"
			30	2.9	1.3	1.2	1.1	0.9	0.9	0.8	0.7	0.6	0.6	30	8	10	11	11'0"
			40	3.5	1.0	0.9	0.9	0.7	0.6	0.5	0.4	0.4	0.4	40	9	11	12	10'0"
	SF 200	Fluid Cap FC2 & Air Cap AC1104	20	2.1	2.0	1.9	1.7	1.5	1.4	1.3	1.2	0.9	0.9	20	7	9	11	10'0"
			30	2.7	2.0	1.9	1.8	1.6	1.5	1.5	1.3	1.0	1.0	30	7	9	12	11'0"
			40	3.3	1.8	1.7	1.6	1.4	1.4	1.3	1.2	1.0	1.0	40	8	11	13	11'0"
50	3.9	1.1	1.0	0.9	0.7	0.7	0.7	0.7	0.7	0.7	0.7	0.7	0.7	0.7	0.7	0.7	0.7	

Standard Materials: Nickel Plated Brass, 303 Stainless Steel and 316 Stainless Steel.

Spray angle performance varies with pressure. Contact BETE for specific data on critical applications.



1/4"XA02 SF 050 F
XA 02 Body; F Hardware

AIR ATOMIZING

CALL 413-772-0846
Call for the name of your nearest BETE representative.

XAEF

Pressure-fed/External Mix/Flat Fan

DESIGN FEATURES

- External mix: allows spraying of viscous materials
- Variable atomization
- Moderate spray angle (60° - 90°)
- Precise metering of the liquid flow rate

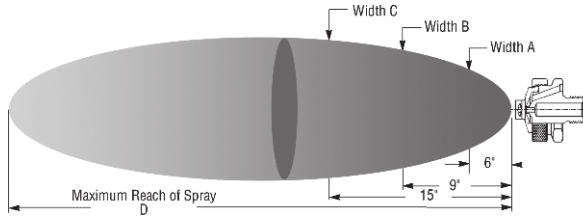

Dimensions are approximate. Check with BETE for critical dimension applications.



1/4" XAEF 150 E
XA 00 Body; E Hardware

AIR ATOMIZING

XAEF Set-up Flow Rates and Dimensions

Pressure-fed, External Mix, Flat Fan Spray Pattern, 1/8" and 1/4" Pipe Sizes

Pipe Size	Spray Set-up Number	Fluid and Air Cap Numbers	3 PSI Liquid			5 PSI Liquid			10 PSI Liquid			20 PSI Liquid			40 PSI Liquid			Spray Dimensions							
			PSI air	GPH	SCFM	PSI air	GPH	SCFM	PSI air	GPH	SCFM	PSI air	GPH	SCFM	PSI air	GPH	SCFM	PSI air	GPH liquid	"A" in.	"B" in.	"C" in.	"D" feet		
1/8	EF 050	Fluid Cap FC7 & Air Cap AC1001	5	0.8	0.8	5	1.0	0.8	6	1.4	0.9	8	2.0	1.0	2.8	1.2	10	2.8	1.6	6	5	8	11	13	4'
			6		0.9	6		0.9	8		1.0	10		1.5		8	10		9	12	16	6'			
			7		1.0	8		1.0	10		1.2	12		1.6		15	20		11	14	18	6'			
			8		1.0	10		1.2	12		1.4	15		1.9		20	20		10	12	16	8'			
	EF 100	Fluid Cap FC7 & Air Cap AC1003	3	0.8	0.9	5	1.0	0.9	10	1.4	1.1	20	2.0	1.6	2.8	2.6	40	2.8	3.0	3	3	4	6	9	3'
			5		0.9	10		1.1	15		1.4	20		1.6		30	2.1		60	3.6	20	5	4	6	9
1/4	EF 150	Fluid Cap FC4 & Air Cap AC1001	5	1.2	0.8	5	1.6	0.8	8	2.2	1.0	10	3.1	1.2	4.4	1.5	15	4.4	1.9	10	5	11	13	16	5'
			8		1.0	10		1.2	10		1.2	20		2.9		20	1.9		10	20	15	18	23	7'	
			10		1.2	15		1.6	20		1.9	30		2.5		30	2.5		25	20	13	16	20	9'	
			15		1.6	20		1.9	30		2.5	35		2.8		35	2.8		25	30	15	18	23	10'	
	EF 200	Fluid Cap FC4 & Air Cap AC1003	5	1.2	0.9	10	1.6	1.1	15	2.2	1.4	25	3.1	1.9	4.4	2.9	45	4.4	3.0	5	3	3	6	9	4'
			10		1.1	15		1.4	20		1.6	30		2.1		50	3.0		20	3	4	6	9	5'	
1/4	EF 250	Fluid Cap FC3 & Air Cap AC1001	6	2.3	0.9	6	3.0	0.9	6	4.2	0.9	10	5.9	1.2	8.4	2.0	20	8.4	2.2	8	5	14	19	24	5'
			7		1.0	8		1.0	8		1.0	12		1.4		25	2.2		10	20	15	19	25	6'	
			8		1.0	9		1.1	10		1.2	15		1.6		30	2.5		20	20	17	21	26	8'	
			10		1.2	10		1.2	12		1.4	20		1.9		35	2.8		25	30	16	20	27	9'	
	EF 300	Fluid Cap FC3 & Air Cap AC1003	10	2.3	1.1	15	3.0	1.4	20	4.2	1.6	35	5.9	2.4	8.4	3.0	50	8.4	3.6	10	3	5	7	10	4'
			15		1.4	20		1.6	25		1.9	40		2.6		60	4.2		80	5.6	75	40	6	8	13

Standard Materials: Nickel Plated Brass, 303 Stainless Steel and 316 Stainless Steel.

Spray angle performance varies with pressure. Contact BETE for specific data on critical applications.

TO ORDER: specify pipe size, body style, spray set-up #, hardware and mounting assemblies, and material. See page 74.

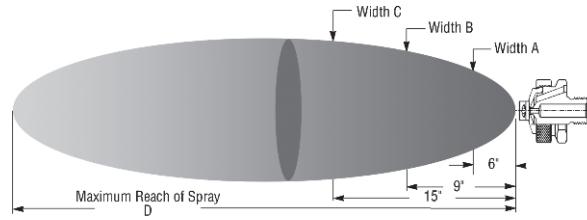

Dimensions are approximate. Check with BETE for critical dimension applications.

XA EF Set-up Flow Rates and Dimensions
Pressure-fed, External Mix, Flat Fan Spray Pattern, 1/8" and 1/4" Pipe Sizes

Pipe Size	Spray Set-up Number	Fluid and Air Cap Numbers	3 PSI Liquid			5 PSI Liquid			10 PSI Liquid			20 PSI Liquid			40 PSI Liquid			Spray Dimensions					
			PSI air	GPH	SCFM	PSI air	GPH	SCFM	PSI air	GPH	SCFM	PSI air	GPH	SCFM	PSI air	GPH	SCFM	PSI air	liquid	"A" in.	"B" in.	"C" in.	"D" feet
1/8 or 1/4	EF 350	Fluid Cap FC6 & Air Cap AC1002	8		3.2	10		3.6	20		5.5	30		7	45		10	20	5	13	15	19	10'0"
			10		3.6	15		4.6	30		7.4	40		9	60		13	30	10	13	16	22	12'0"
			15	3.6	4.6	25		6.5	35		8.3	50		11	75		15	60	20	15	19	25	15'0"
	EF 400	Fluid Cap FC6 & Air Cap AC1004	20		5.5	30		7.4	40		9.1	60		13	80		16	55	30	16	20	27	15'0"
			25		6.9	40		8.0	50		9.1	60		13	80		16	60	40	15	20	28	16'0"
			30	3.6	4.9	30		5.5	35		6.3	60		9	60		10	35	10	6	9	11	11'0"
			40		5.5	40		6.9	40		6.9	70		11	70		11	35	20	7	9	14	12'0"
			50		6.9	50		8.0	50		8.0	80		13	80		13	60	20	7	9	15	13'0"
	EF 450	Fluid Cap FC2 & Air Cap AC1002	8		3.2	10		3.6	15		4.6	35		8	50		11	25	3	13	15	20	11'0"
			15		4.6	20		5.5	25		6.5	45		10	65		14	35	20	15	18	25	12'0"
			20	4.8	5.5	25		6.5	35		8.3	55		12	85		17	60	20	12	17	23	16'0"
	EF 500	Fluid Cap FC2 & Air Cap AC1004	25		6.5	30		7.4	40		9.1	60		13	95		19	60	30	13	17	24	16'0"
30				8.0	40		9.4	60		11.0	90		15	95		15	70	40	13	17	24	16'0"	
40			4.8	4.9	35		6.3	40		6.9	60		9	75		12	40	10	6	9	14	12'0"	
50				6.9	50		8.0	60		9.4	80		11	90		13	60	20	7	10	15	13'0"	
50				8.0	60		9.4	70		11.0	90		15	95		15	75	40	7	9	14	17'0"	
EF 550	Fluid Cap FC1 & Air Cap AC1002	10		3.6	15		4.6	25		6.5	45		10	75		15	30	5	16	22	30	11'0"	
		15		4.6	20		5.5	30		7.4	50		11	85		17	40	10	18	23	32	13'0"	
		20	9.9	5.5	30		7.4	40		9.1	70		14	95		19	65	20	17	21	30	16'0"	
EF 600	Fluid Cap FC1 & Air Cap AC1004	25		6.5	35		8.3	45		10.0	80		16	100		19	80	20	15	20	26	19'0"	
		30		8.0	50		9.4	60		11.0	90		15	100		16	90	40	19	25	33	14'0"	
		35	9.9	6.3	45		7.5	60		9	70		11	80		13	50	10	8	11	15	13'0"	
		40		6.9	50		8.0	70		11	80		13	90		15	60	20	8	11	16	14'0"	
		50		8.0	60		9.4	80		13	90		15	100		16	80	40	7	10	15	18'0"	
EF 650	Fluid Cap FC8 & Air Cap AC1005	25		3.6	15		4.6	25		6.5	45		10	75		15	30	5	16	22	30	11'0"	
		30		4.1	30		5.5	40		7	50		8	60		10	40	3	6	8	10	12'0"	
		35	10.0	4.9	35		6.3	45		8	60		9	70		11	50	10	7	10	14	11'0"	
EF 700	Fluid Cap FC9 & Air Cap AC1005	40		6.3	45		7.5	60		9	70		11	80		13	60	20	8	11	16	14'0"	
		45		8.0	60		9.4	80		11	90		13	90		15	70	40	7	10	15	18'0"	
		50	17.4	12	50		13	65		15	70		17	80		21	70	10	7	10	14	14'0"	
		60		13	60		16	75		20	90		24	90		24	70	20	8	10	15	18'0"	
		70		16	70		18	80		21	90		24	90		24	80	20	8	10	15	19'0"	
EF 750	Fluid Cap FC5 & Air Cap AC1005	40		12	50		13	65		17	80		21	80		23	40	3	8	10	14	14'0"	
		45		13	55		14	70		18	85		22	85		24	55	3	8	10	15	15'0"	
		50	27.9	13	60		16	75		20	90		24	90		24	65	5	8	10	15	17'0"	
EF 750	Fluid Cap FC5 & Air Cap AC1005	55		15	65		17	80		21	90		24	90		24	75	10	9	11	15	18'0"	
		65		16	70		18	85		23	95		26	95		26	80	15	9	11	16	18'0"	
		70		17	75		20	90		24	90		26	95		26	80	20	9	11	16	19'0"	
		70		18	80		21	90		24	90		26	95		26	85	20	9	11	16	19'0"	
		70		18	80		21	90		24	90		26	95		26	85	20	9	11	16	19'0"	

AIR ATOMIZING

CALL 413-772-0846
 Call for the name of your nearest BETE representative.

Standard Materials: Nickel Plated Brass, 303 Stainless Steel and 316 Stainless Steel.

Spray angle performance varies with pressure. Contact BETE for specific data on critical applications.

XAER

Pressure-fed/Ext. Mix/Narrow Angle Round

DESIGN/SPRAY CHARACTERISTICS

- External mix: allows spraying of viscous liquids
- Variable atomization
- Narrow spray angle (10°- 30°)
- Precise metering of liquid flow rate

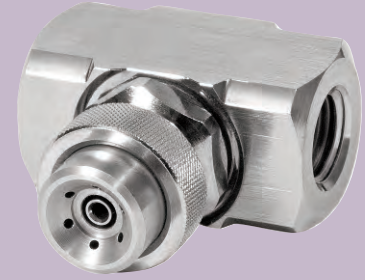
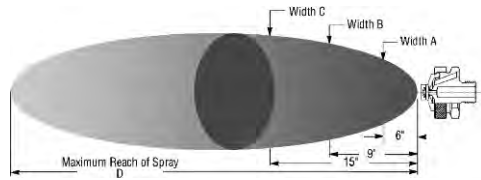

1/4" XAER850A
XA 00 Body; A Hardware

Dimensions are approximate. Check with BETE for critical dimension applications.

XA ER Set-up Flow Rates and Spray Dimensions

Pressure-fed, External Mix, Narrow Round Spray Pattern, 1/8" and 1/4" Pipe Sizes

Pipe Size	Spray Set-up Number	Fluid and Air Cap Numbers	3 PSI Liquid			5 PSI Liquid			10 PSI Liquid			20 PSI Liquid			40 PSI Liquid			Spray Dimensions								
			PSI air	GPH	SCFM	PSI air	GPH	SCFM	PSI air	GPH	SCFM	PSI air	GPH	SCFM	PSI air	GPH	SCFM	PSI Liquid	Air	A	B	C	D			
1/8"	ER 050	Fluid Cap FC7 & Air Cap AC1801	5	0.7	0.8	5	0.8	0.8	5	1.2	1.2	1.2	10	1.7	1.7	1.7	20	2.4	1.8	3	10	2	3	4	5	8
		10	1.2	1.2	10	1.2	1.2	10	1.2	1.2	1.2	20	1.8	1.8	20	2.3	2.3	2.3	30	5	20	3	4	4	10	
		20	1.8	1.8	20	1.8	1.8	20	1.8	1.8	1.8	30	2.3	2.3	30	2.9	2.9	2.9	40	5	40	2	3	5	12	
	ER 150	Fluid Cap FC4 & Air Cap AC1801	5	1.0	0.8	5	0.8	0.8	5	1.2	1.2	1.2	10	2.0	2.0	2.0	20	4.0	1.8	3	10	2	3	3	3	10
		10	1.2	1.2	10	1.2	1.2	10	1.2	1.2	1.2	20	1.8	1.8	20	2.3	2.3	2.3	30	5	20	3	3	3	14	
		20	1.8	1.8	20	1.8	1.8	20	1.8	1.8	1.8	30	2.3	2.3	30	2.9	2.9	2.9	40	5	40	2	3	5	16	
	ER 250	Fluid Cap FC3 & Air Cap AC1801	6	2.0	0.9	6	0.9	0.9	6	1.2	1.2	1.2	10	4.0	4.0	4.0	20	6.0	1.8	3	10	3	4	4	4	10
		10	1.2	1.2	10	1.2	1.2	10	1.2	1.2	1.2	20	1.8	1.8	20	2.3	2.3	2.3	30	5	20	3	3	5	14	
		20	1.8	1.8	20	1.8	1.8	20	1.8	1.8	1.8	30	2.3	2.3	30	2.9	2.9	2.9	40	5	40	3	3	5	14	
	ER 350	Fluid Cap FC6 & Air Cap AC1802	10	3.3	3.4	10	3.4	3.4	10	4.5	4.5	4.5	15	5.7	5.7	5.7	30	11.9	7.2	3	10	3	5	6	9	
		15	4.5	4.5	15	4.5	4.5	15	4.5	4.5	4.5	20	5.5	5.5	20	7.2	7.2	7.2	30	5	20	3	4	6	11	
		20	5.5	5.5	20	5.5	5.5	20	5.5	5.5	5.5	30	7.2	7.2	30	8.9	8.9	8.9	40	5	40	3	4	6	16	
ER 450	Fluid Cap FC2 & Air Cap AC1802	10	5.0	3.4	10	3.4	3.4	10	4.5	4.5	4.5	15	8.8	8.8	8.8	30	13	7.2	3	10	4	6	9	14		
	15	4.5	4.5	15	4.5	4.5	15	4.5	4.5	4.5	20	5.5	5.5	20	7.2	7.2	7.2	30	5	20	4	5	6	18		
	20	5.5	5.5	20	5.5	5.5	20	5.5	5.5	5.5	30	7.2	7.2	30	8.9	8.9	8.9	40	5	40	5	5	7	21		
ER 550	Fluid Cap FC1 & Air Cap AC1802	15	10	4.5	15	4.5	4.5	15	5.5	5.5	5.5	20	18	18	18	50	30	7.2	3	10	4	6	9	16		
	20	5.5	5.5	20	5.5	5.5	20	5.5	5.5	5.5	30	7.2	7.2	30	8.9	8.9	8.9	40	5	20	5	6	9	15		
	30	7.2	7.2	30	7.2	7.2	30	7.2	7.2	7.2	40	8.9	8.9	40	10.6	10.6	10.6	50	5	40	5	7	7	21		
ER 650	Fluid Cap FC8 & Air Cap AC1803	15	10	7.2	15	7.2	7.2	15	8.8	8.8	8.8	20	18	18	18	50	30	7.2	3	10	4	6	9	16		
	20	7.2	7.2	20	7.2	7.2	20	7.2	7.2	7.2	30	8.8	8.8	30	11.7	11.7	11.7	40	5	20	5	6	8	17		
	25	10.3	10.3	25	10.3	10.3	25	10.3	10.3	10.3	30	11.7	11.7	30	12.2	12.2	12.2	40	5	20	5	5	6	22		
ER 750	Fluid Cap FC9 & Air Cap AC1803	20	17	8.8	20	8.8	8.8	20	11.7	11.7	11.7	25	29	29	29	50	42	7.2	3	10	6	6	9	19		
	30	11.7	11.7	30	11.7	11.7	30	11.7	11.7	11.7	40	14.5	14.5	40	18.5	18.5	18.5	50	5	20	6	6	8	21		
	40	14.5	14.5	40	14.5	14.5	40	14.5	14.5	14.5	50	17.2	17.2	50	19.8	19.8	19.8	60	5	40	6	7	7	22		
ER 850	Fluid Cap FC5 & Air Cap AC1803	40	25	14.5	40	14.5	14.5	40	18.5	18.5	18.5	50	42	42	42	80	61	7.2	3	10	6	6	7	22		
	50	17.2	17.2	50	17.2	17.2	50	17.2	17.2	17.2	60	21.1	21.1	60	25.2	25.2	25.2	70	5	20	4	5	7	20		
	55	18.5	18.5	55	18.5	18.5	55	18.5	18.5	18.5	65	21.1	21.1	65	25.2	25.2	25.2	80	5	40	3	4	6	18		
60	19.8	19.8	60	19.8	19.8	60	19.8	19.8	19.8	70	22.5	22.5	70	25.2	25.2	25.2	80	5	40	4	4	6	18			
65	21.1	21.1	65	21.1	21.1	65	21.1	21.1	21.1	80	25.2	25.2	80	27.9	27.9	27.9	90	5	40	3	4	6	19			

Standard Materials: Nickel Plated Brass, 303 Stainless Steel, and 316 Stainless Steel.

Spray angle performance varies with pressure. Contact BETE for specific data on critical applications.

XAFF

Pressure-fed/Int. Mix/Deflected Flat Fan

DESIGN/SPRAY CHARACTERISTICS

- Internal mix
- Deflected flat fan spray pattern

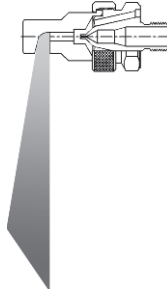

1/4"XA 01 FF050 F
XA01 Body; F Hardware

XA FF Set-up Flow Rates

Pressure-fed, Internal Mix, Deflected Flat Fan Spray Pattern, 1/8" and 1/4" Pipe Sizes

Pipe Size	Spray Set-up Number	Fluid and Air Cap Numbers	10 PSI Liquid			20 PSI Liquid			30 PSI Liquid			40 PSI Liquid			60 PSI Liquid		
			PSI air	GPH	SCFM	PSI air	GPH	SCFM	PSI air	GPH	SCFM	PSI air	GPH	SCFM	PSI air	GPH	SCFM
1/8 or 1/4	FF 050	Fluid Cap FC10 & Air Cap AC1701	6	2.9	1.6	14	3.9	2.6	22	4.7	3.3	26	5.8	3.6	38	7.4	4.6
			8	2.5	1.9	16	3.5	2.8	24	4.3	3.6	32	4.8	4.4	46	6.4	5.5
			10	2.0	2.3	18	3.1	3.1	26	4.0	3.8	38	3.8	5.3	54	5.3	6.6
			12	1.5	2.7	20	2.8	3.5	30	3.3	4.5	44	2.8	6.2	62	4.2	7.8
			22	2.3	3.8	34	2.3	5.2	46	2.3	6.6	70	2.8	9.4			

XAxw

Pressure-fed/Int. Mix/Extra-wide Angle

DESIGN/SPRAY CHARACTERISTICS

- Internal mix
- 180° Extra-wide hollow cone

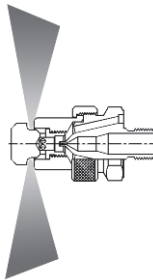

1/4"XA 03 XW050 A
XA 03 Body; A Hardware

XA XW Set-up Flow Rates

Pressure-fed, Internal Mix, Extra-Wide Spray pattern, 1/8" and 1/4" Pipe Sizes

Pipe Size	Spray Set-up Number	Fluid and Air Cap Numbers	10 PSI Liquid			20 PSI Liquid			30 PSI Liquid			40 PSI Liquid			60 PSI Liquid		
			PSI air	GPH	SCFM	PSI air	GPH	SCFM	PSI air	GPH	SCFM	PSI air	GPH	SCFM	PSI air	GPH	SCFM
1/8 or 1/4	XW 050	Fluid Cap FC8 & Air Cap AC1401	20	4.0	2.5	34	6.6	4.1	50	7.1	6.4	60	11.0	7.6	85	14.4	11.8
			22	2.8	2.7	38	4.4	4.8	52	6.2	6.8	65	8.3	8.6	90	12.0	13.0
			24	2.0	3.0	42	2.8	5.5	56	4.4	7.6	70	6.1	9.8	95	9.8	14.1
			26	1.5	3.3	46	1.7	6.3	60	3.2	8.4	80	3.1	12.4	100	7.8	15.4
			28	1.1	3.6	48	1.3	6.9	70	1.3	11.8	90	1.4	15.4			

Standard Materials: Nickel Plated Brass, 303 Stainless Steel and 316 Stainless Steel.

AIR ATOMIZING

CALL 413-772-0846
Call for the name of your nearest BETE representative.

1/2 XA

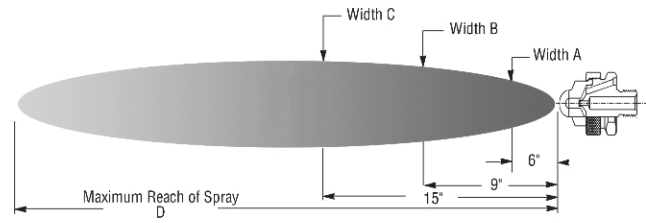

Air Atomizing

Dimensions are approximate. Check with BETE for critical dimension applications.

AD 1/2" XA AD Set-up Flow Rates and Dimensions Pressure-fed, Internal Mix, Narrow Angle Round Spray Pattern, 1/2" Pipe Sizes

Pipe Size	Spray Set-up Number	Fluid and Air Cap Numbers	5 PSI Liquid			15 PSI Liquid			25 PSI Liquid			35 PSI Liquid			55 PSI Liquid			Spray Dimensions						
			PSI air	GPH	SCFM	PSI air	GPH	SCFM	PSI air	GPH	SCFM	PSI air	GPH	SCFM	PSI air	GPH	SCFM	PSI air	liquid	A (in.)	B (in.)	C (in.)	D (feet)	
1/2	AD 5050	Fluid Cap FC 501 & Air Cap AC 5601							28	33.0	8.40	40	28.8	11.3	58	66.0	12.2	30	25	13.5	19.0	26.5	22	
									30	19.8	10.8	42	15.6	13.9	60	42.0	15.0	40	35	13.5	19.0	26.5	24	
															62	25.5	18.2	60	55	14.0	19.5	27.0	28	
	AD 5100	Fluid Cap FC 501 & Air Cap AC 5602	8	27.0	6.50	18	42.0	7.00	32	47.0	11.0	46	42.6	18.1	70	81.0	30.0	10	5.0	13.0	18.5	25.5	20	
			10	15.0	8.20	20	29.4	8.80	34	36.0	12.8	48	32.4	20.2	75	45.0	35.0	20	15	13.5	19.0	25.5	26	
			12	8.4	9.80	22	20.2	10.5	36	25.2	14.7	50	25.8	22.2	80	22.2	39.6	36	25	13.0	18.5	26.5	21	
						24	14.4	12.2	38	18.6	16.6	52	19.8	24.0				50	35	13.5	19.0	26.5	24	
	AD 5150	Fluid Cap FC 501 & Air Cap AC 5603	10	34.2	11.4	26	46.2	20.2	40	62.6	27.5	54	75.6	32.6	75	127	39.0	12	5.0	14.0	19.5	27.0	26	
			12	21.6	13.0	28	37.2	22.0	42	52.8	29.6	56	57.0	34.3	80	108	42.0	30	15	13.5	19.0	26.5	24	
			14	12.0	14.7	30	28.4	23.7	44	42.0	31.6	58	46.8	35.8	85	98	46.0	46	25	13.0	18.5	26.0	23	
						32	21.6	25.3	46	33.6	33.6	60	39.0	37.3				60	35	14.0	19.5	27.0	28	
	AD 5200	Fluid Cap FC 502 & Air Cap AC 5604				18	103	15.4	26	155	17.7	36	180	23.0	54	222	29.1	10	5.0	13.0	25.0	36.0	11	
						20	81.6	17.6	28	135	20.0	38	162	25.4	56	204	31.2	20	15	11.0	26.0	36.0	16	
						22	63.6	19.8	30	115	22.5	40	147	27.8	58	192	34.0	32	25	11.0	22.0	32.0	20	
						24	49.3	22.6	32	100	25.1	42	131	30.2	60	180	36.3	44	35	11.0	21.0	29.0	22	
									34	84.0	27.5	44	116	32.6	62	166	38.9	64	55	11.0	22.0	31.0	25	
									36	69.5	30.0	46	101	35.1	64	154	41.6							
									38	56.4	32.6	48	85.0	37.6	66	142	44.1							
									40	45.7	35.3	50	75.0	40.2	68	130	46.6							
																		70	119	49.3				
																	72	108	51.6					

PR 1/2" XA PR Set-up Flow Rates and Dimensions Pressure-fed, Internal Mix, Narrow Angle Round Spray Pattern, 1/2" Pipe Sizes

Pipe Size	Spray Set-up Number	Fluid and Air Cap Numbers	5 PSI Liquid			15 PSI Liquid			25 PSI Liquid			35 PSI Liquid			55 PSI Liquid			Spray Dimensions						
			PSI air	GPH	SCFM	PSI air	GPH	SCFM	PSI air	GPH	SCFM	PSI air	GPH	SCFM	PSI air	GPH	SCFM	PSI air	liquid	A (in.)	B (in.)	C (in.)	D (feet)	
1/2	PR 5050	Fluid Cap FC 501 & Air Cap AC 5501	18	9.00	12.4	28	31.7	14.9	38	58.0	17.3	48	80.0	19.3				20	5.0				22	
			20	6.70	13.7	32	22.5	17.0	44	37.7	20.8	54	55.2	23.6				36	15				24	
			22	5.40	14.7	38	15.9	19.3	50	24.7	24.8	60	40.0	27.5				50	25	3.5	6.5	10	27	
			24	4.10	15.7	36	13.2	20.4	54	19.5	27.5	66	30.0	32.1				60	35				30	
						40	11.1	21.5	58	16.0	30.2	72	23.3	37.0										
	PR 5100	Fluid Cap FC 502 & Air Cap AC 5502	10	35.4	11.1	18	103	15.4	26	155	17.7	36	180	23.0	54	222	29.1	10	5.0	4.0	7.0	9.0	23	
			12	26.4	13.4	20	81.6	17.6	28	135	20.0	36	162	25.4	56	205	31.2	20	15	6.0	10	13	21	
						22	63.6	19.8	30	115	22.5	40	147	27.8	58	190	34.0	32	25	5.0	8.0	10	37	
						24	49.3	22.6	32	100	25.1	42	131	30.2	60	178	36.3	44	35	4.0	7.0	10	41	
									34	84.0	27.5	44	116	32.6	62	166	38.9	64	55	4.0	7.0	10	47	
									36	69.5	30.0	46	101	35.1	64	154	41.6							
									38	56.4	32.6	48	85.0	37.6	66	142	44.1							
									40	45.7	35.3	50	73.0	40.2	68	130	46.6							
																		70	119	49.3				
																		72	108	51.6				
																		74	97.4	54.2				
																		76	87.5	57.1				

Standard Materials: Nickel Plated Brass, 303 Stainless Steel, and 316 Stainless Steel.

Spray angle performance varies with pressure. Contact BETE for specific data on critical applications.

Dimensions are approximate. Check with BETE for critical dimension applications.

EF

1/2" XA EF Set-up Flow Rates and Dimensions

Pressure-fed, External Mix, Flat Fan Spray Pattern, 1/2" Pipe Sizes

Pipe Size	Spray Set-up Number	Fluid and Air Cap Numbers	3 PSI Liquid			5 PSI Liquid			7 PSI Liquid			10 PSI Liquid			15 PSI Liquid			Spray Dimensions					
			PSI air	GPH	SCFM	PSI air	GPH	SCFM	PSI air	GPH	SCFM	PSI air	GPH	SCFM	PSI air	GPH	SCFM	PSI air	liquid	A (in.)	B (in.)	C (in.)	D (feet)
1/2	EF 5050	Fluid Cap FC501 & Air Cap AC5001	30		31.0	40		38.0	45		41.5	55		48.0	80		65	35	3	8.5	14.5	20.5	19
			35		34.0	45		41.5	50		45.0	60		51.5	85		69	50	5	9.0	16.5	21.5	22
			40	138	38.0	50	180	45.0	55	210	48.0	70	252	58.0	90	306	72	55	7	9.5	17.5	23.0	23
			45		41.5	55		48.0	60		51.5	75		62.0	95		75	70	10	9.5	18.5	24.0	25
						60		51.5	65		55.0	80		65.0	100		78	90	15	10	19.5	26.0	29
						70		58.0	85		69.0												

PF

1/2" XA PF Set-up Flow Rates and Dimensions

Pressure-fed, Internal Mix, Flat Fan Spray Pattern, 1/2" Pipe Sizes

Pipe Size	Spray Set-up Number	Fluid and Air Cap Numbers	5 PSI Liquid			15 PSI Liquid			25 PSI Liquid			35 PSI Liquid			55 PSI Liquid			Spray Dimensions							
			PSI air	GPH	SCFM	PSI air	GPH	SCFM	PSI air	GPH	SCFM	PSI air	GPH	SCFM	PSI air	GPH	SCFM	PSI air	liquid	A (in.)	B (in.)	C (in.)	D (feet)		
1/2	PF5050	Fluid Cap FC501 & Air Cap AC5301				28		39.0	22.4	44		44.1	31.5	58		53.0	40.0			20	10	17	28	35	18
			30			30		31.8	24.0	46		37.2	33.5	60		45.6	42.0			30	15	18	29	36	19
			32			32		24.6	25.9	48		31.2	35.1	62		38.0	44.0			40	20	19	30	37	21
			34			34		19.8	27.5	50		26.0	36.9	65		31.0	47.0			50	25	20	31	38	23
			36			36		15.0	29.1	60		20.6	38.7	70		21.0	52.5			60	35	24	36	43	27
																					70	40	26	39	46
	PF 5100	Fluid Cap FC502 & Air Cap AC5302	10	35.4	11.1	18	103	15.4	26	155	17.7	36	180	23.0	54	222	29.1		10	5.0	20	34	47	13	
			12	26.4	13.4	20	81.6	17.6	28	135	20.1	36	162	25.4	56	205	31.2		20	15	34	62	83	15	
						22	63.6	19.8	30	115	22.5	40	147	27.8	58	190	34.0		20	15	34	62	83	15	
						24	49.3	22.6	32	100	25.1	42	131	30.2	60	178	36.3		32	25	34	62	82	17	
						34	84.0	27.5	34	84.0	27.5	44	116	32.6	62	166	38.9	44	35	36	66	85	19		
						36	69.5	30.0	36	69.5	30.0	46	101	35.1	64	154	41.6	64	55	36	67	89	21		
						38	56.4	32.6	38	56.4	32.6	48	85.0	37.6	66	142	44.1								
						40	45.7	35.3	40	45.7	35.3	50	73.0	40.2	68	130	46.6								
												52	62.4	42.7	70	119	49.3								
															72	108	51.6								
															74	97.4	54.2								
															76	87.5	57.1								

AIR ATOMIZING

SR

1/2" XA SR Set-up Flow Rates and Dimensions

Siphon-fed, External Mix, Narrow Angle Round Spray Pattern, 1/2" Pipe Sizes

Pipe Size	Spray Set-up Number	Fluid and Air Cap Numbers	ATOMIZING AIR		Liquid Capacity in GPH (Gallons Per Hour)								Spray Dimensions at 8" Siphon Ht.																	
			PSI air	Air Capacity SCFM	Gravity Head			Siphon Height					PSI air	B (in.)	D (feet)															
					18"	12"	6"	4"	8"	12"	24"																			
1/2	SR 5050	Fluid Cap FC501 & Air Cap AC5201	10	12.7																						20				
			20	18.5																								30		
			30	24.0																									40	
			43	29.2																									50	
			50	34.8			79.8		67.6	58.8																			60	
			60	40.1			81.9		70.5	62.8																				70
			70	46.1			83.2		72.1	63.5																				80
			80	51.0			84.6		74.5	66.0																				80

Call for the name of your nearest BETE representative.

XW

1/2" XA XW Set-up Flow Rates and Dimensions

Pressure-fed, Internal Mix, 180° Extra-Wide Angle, Hollow Cone Spray Pattern, 1/2" Pipe Sizes

Pipe Size	Spray Set-up Number	Fluid and Air Cap Numbers	10 PSI Liquid			20 PSI Liquid			30 PSI Liquid			40 PSI Liquid			40 PSI Liquid		
			PSI air	GPH	SCFM	PSI air	GPH	SCFM	PSI air	GPH	SCFM	PSI air	GPH	SCFM	PSI air	GPH	SCFM
1/2	XW 5050	Fluid Cap FC502 & Air Cap AC5401	14	56.4	12.2	24	104	16.0	36	116	22.4	48	122	27.8	72	128	40.2
			16	38.4	14.8	26	85.8	18.6	38	98.4	24.8	50	110	29.8	74	116	42.3
			18	25.8	16.8	28	70.0	20.3	40	85.2	26.5	52	98.4	31.5	76	108	44.3
			20	15.6	19.0	30	54.6	22.7	42	73.2	28.9	54	85.8	33.8	78	96.6	46.3
						32	42.0	24.8	44	61.0	30.9	56	74.4	36.0	80	85.8	48.3
						34	30.6	26.8	46	49.8	35.0	58	66.0	38.3	82	78.6	50.5
						36	20.0	29.3	48	38.4	35.0	60	55.2	40.1	84	67.8	52.5
						38	7.20	31.8	50	30.0	37.8	62	44.4	42.0	86	60.0	54.8
												64	37.2	44.5	90	48.0	59.0
												66	20.4	45.8			

Standard Materials: Nickel Plated Brass, 303 Stainless Steel and 316 Stainless Steel.

Spray angle performance varies with pressure. Contact BETE for specific data on critical applications.

SAM

External Mix/Flat Fan or Narrow Round

DESIGN FEATURES

- Separate atomizing and fan air lines provide variable coverage and fine control of drop size without affecting liquid flow rates. Higher atomizing air pressure yields finer drop size; higher fan air pressure yields broader patterns
- Pneumatically-controlled shut-off and clean-out built in
- External mix; allows spraying of viscous materials
- Liquid flow rates are independent of air
- Precise metering of the liquid flow rate
- Removable plug provided for liquid recirculation port

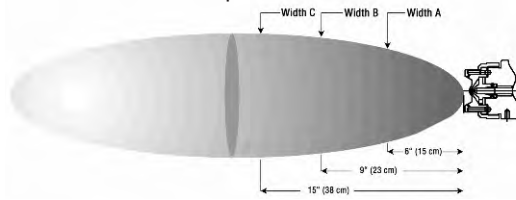

AIR ATOMIZING

SAM Liquid Flow Rates

Pipe Size	Spray Set-up Number	Fluid Cap and Air Cap Number	Liquid Capacity GPH @ PSI				
			3 PSI	5 PSI	10 PSI	15 PSI	20 PSI
1/8	SAM-01-02	FCS 01 & ACS 02	0.70	1.00	1.40	1.70	1.90
	SAM-02-02	FCS 02 & ACS 02	1.10	1.50	2.10	2.50	2.90
	SAM-03-02	FCS 03 & ACT 02	2.20	2.80	4.00	4.90	5.60
	SAM-04-03	FCS 04 & ACS 03	3.60	4.70	6.60	8.00	9.40
	SAM-05-03	FCS 05 & ACS 03	4.90	6.40	9.00	11.0	12.8
	SAM-06-04	FCS 06 & ACS 04	10.0	13.0	18.4	23.0	26.0
	SAM-07-05	FCS 07 & ACS 05	18.3	24.0	33.0	41.0	47.0

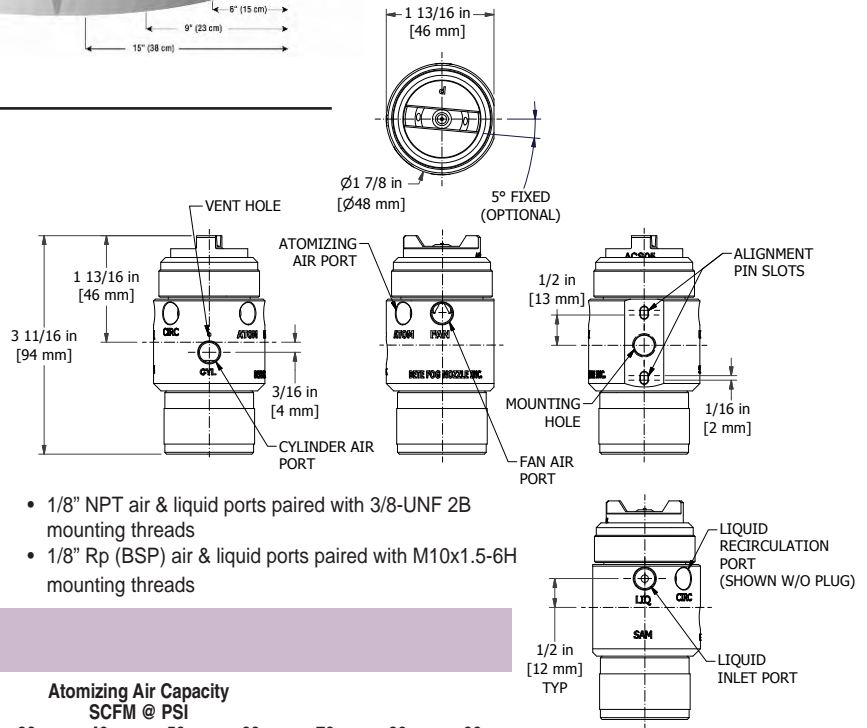

- 1/8" NPT air & liquid ports paired with 3/8-UNF 2B mounting threads
- 1/8" Rp (BSP) air & liquid ports paired with M10x1.5-6H mounting threads

SAM Air Flow Rates

Pipe Size	Spray Set-up Number	Fluid Cap and Air Cap Number	Atomizing Air Capacity SCFM @ PSI									
			10 PSI	15 PSI	20 PSI	30 PSI	40 PSI	50 PSI	60 PSI	70 PSI	80 PSI	90 PSI
1/8	SAM-01-02	FCS 01 & ACS 02	0.44	0.53	0.62	0.82	1.00	1.30	1.50	1.70	2.00	2.20
	SAM-02-02	FCS 02 & ACS 02										
	SAM-03-02	FCS 03 & ACS 02										
	SAM-04-03	FCS 04 & ACS 03										
	SAM-05-03	FCS 05 & ACS 03										
	SAM-06-04	FCS 06 & ACS 04										
SAM-07-05	FCS 07 & ACS 05	1.60	2.00	2.40	3.10	3.90	4.70	5.40	6.20	7.00	7.80	

Pipe Size	Spray Set-up Number	Fluid Cap and Air Cap Number	Fan Air Capacity SCFM @ PSI									
			10 PSI	15 PSI	20 PSI	30 PSI	40 PSI	50 PSI	60 PSI	70 PSI	80 PSI	90 PSI
1/8	SAM-01-02	FCS 01 & ACS 02	2.20	2.70	3.30	4.40	5.50	6.60	7.60	8.60	9.60	10.6
	SAM-02-02	FCS 02 & ACS 02										
	SAM-03-02	FCS 03 & ACS 02										
	SAM-04-03	FCS 04 & ACS 03										
	SAM-05-03	FCS 05 & ACS 03										
	SAM-06-04	FCS 06 & ACS 04										
SAM-07-05	FCS 07 & ACS 05	3.50	4.40	5.40	7.20	8.90	10.6	12.3	14.0	15.5	17.2	

Note: Spray set-ups consist of fluid and air caps. Set-ups are interchangeable but each clean-out/shut-off needle uses a different needle size.

Pneumatically-Controlled Clean-out/ Shutoff. Removal of air pressure to the cylinder causes a spring loaded poppet valve actuator to shut off liquid flow and extends a clean-out needle through the nozzle orifice.

Replacement air caps include replacement Blue-Gard® gaskets.

Standard Materials: 303 Stainless Steel, Blue-Gard® Gasket, Viton® O-rings

Spray angle performance varies with pressure. Contact BETE for specific data on critical applications.

TO ORDER: specify pipe size, body style, spray set-up #, hardware and mounting assemblies, and material.

Dimensions are approximate. Check with BETE for critical dimension applications.

SAM Coverage Chart

Variable Spray, Pressure Fed, Flat Fan or *Narrow Round Spray Pattern

Pipe Size	Spray Set-up Number	Fluid Cap and Air Cap Number	Spray Dimensions with Varied Fan Air Pressure																		
			PSI air	PSI liquid	0° PSI			10 PSI			40 PSI			60 PSI							
					A in.	B in.	C in.	A in.	B in.	C in.	A in.	B in.	C in.	A in.	B in.	C in.					
1/8	SAM-01-02	FCS 01 & ACS 02	10	3 10 20	2 2.5 2	3 3.5 3	4 4.5 4	7 7.5 8	9 10 12	10 12 14	6 7 9	8 8 11	11 11 14	6 7 8	8 8 10	11 12 13					
			30	3 10 20	2 2 2	3 2.5 3	4.5 5 4	5 6 7	6 7.5 9	7 10 13	8 8 10	10 10 12	14 13 15	8 8 9.5	11 10 11.5	14 10 14.5					
			40	3 10 20	2 2 2	2.5 3 3	3.5 3 4.5	6 5 7	5 6 8	6 7 10	8 10 12	8 9 10	10 11 14	14 14 14	9 9 10	11 11 11	14 13 13				
			60	3 10 20	2 2 2	2.5 3 3	3.5 3 4.5	6 5 5.5	4 4.5 5	5 5 7	6 6 9	8 8 9	11 10 12	14 14 16	13 9 10	9 9 10	11 12 13	14 15 17			
			SAM-02-02	FCS 02 & ACS 02	10	3 10 20	2 2 2	3 3.5 3	4 4.5 4	8 8 8	10 12 15	12 15 15	6.5 9 9	8.5 14 18	11 18 18	6 7 8	9 10 10	12 13 13			
					30	3 10 20	2 2 2	3 3 3	4.5 5 4.5	5.5 7 7	7 8 9	8 9 12.5	8 8.5 11.5	10 12 15	14 14 17	14 14 17	8 9 11	11 10 14	14 15 18		
					40	3 10 20	2 2 2	2.5 3 3	3.5 5 4.5	6 7 6.5	5 8 9	7 8 9	9 9.5 12.5	8 9.5 11.5	10 12 15	14 14 17	9 9 11	11 12 14	14 15 18		
					60	3 10 20	2 2 2	2.5 3 3	3.5 4 4.5	6 5.5 5.5	4.5 5 5.5	5.5 6 7.5	7 8.5 9.5	8 9 10	10.5 11 14	13 14 18	9 10 11	11 12 14	14 15 18		
					SAM-03-02	FCS 03 & ACS 02	10	3 10 20	2 2 2	3 2.5 3	5 4 4	9 12 10	12 15 12	15 21 16	7 12 12	9 20 23	11 23 23	7 7 7	9 10 9	12 13 13	
							30	3 10 20	2 2 2	2.5 3 2.5	4.5 5 4	6 8 8	8 11 12	9 15 14	8 11 16	10 13 20	13 13 22	8 10 11	10 11 11	13 13 13	
							40	3 10 20	2 2 2	2.5 3 3	3.5 5 5	5 7 7	7 8 9	10 10 13.5	8 8 11	10 13 18	13 15 21	13 15 21	8 10 12	11 12 17	13 13 21
							60	3 10 20	2 2 2	2.5 3 3	3.5 5.5 4.5	5.5 6 6	5 6 8	6 7 10	8 9.5 10	8 10 12	10 13 18	13 16 22	8 11 13	10 13 18	14 15 21
	SAM-04-03	FCS 04 & ACS 03					10	3 10 20	2 2 2	2.5 3 3	5 4.5 5	9 10 9	13 14 13	17 17 16							
							30	3 10 20	2 2.5 2.5	3 3.5 3.5	5 5.5 5.5	4 5 5	5 6 9	7 9 13	7 9 13	11 13 20	15 17 24	18 22 24	12 18 17	15 21 22	18 26 27
							40	3 10 20	2 2.5 2.5	2.5 3.5 3.5	5 5 5	3.5 4 5.5	4.5 5 8	6.5 7 11	9 10 15	9 10 15	12 14 21	14 18 21	11 15 16	13 18 20	18 22 25
							60	3 10 20	2 2.5 2.5	2.5 3.5 3.5	5 4.5 4.5	3 3 4.5	4 6 7	6 8 10	8 9 10	10 12 16	13 14 16	13 16 22	8 11 12	10 11 17	12 15 22
			SAM-05-03	FCS 05 & ACS 03			10	3 10 20	3 3 3	4 4 4	6 6 6	9 8 9	12 11 12	18 15 15	24 21 21	29 28 28	35 35 35				
							30	3 10 20	2 2.5 2	3.5 3.5 3	6 5 5	4 4.5 6	6 6 9	8 8 9	12 14 15	15 18 19	19 23 27	23 27 27	12 17 18	15 22 23	19 25 25
							40	3 10 20	2 2.5 2.5	2.5 3.5 3.5	6 5.5 5.5	3.5 4 3.5	5 6 9	7 8 9	10 12 13	13 16 17	17 20 22	22 26 26	12 15 16	14 18 20	18 22 24
							60	3 10 20	2 2.5 2.5	2.5 3.5 3.5	6 5.5 5.5	2.5 3 4	4 4 6	7 7 9	9 10 13	11 13 17	14 16 22	16 20 22	10 13 12	12 16 17	17 20 23
					SAM-06-04	FCS 06 & ACS 04	10	3 10 20	3 3 3	4 4 4	5 5 5	7 4 4	10 6 6	13 8 8.5	21 12 13	26 14 16	33 21 21	22 15 18			
							30	3 10 20	3 2.5 2.5	4 3.5 3.5	5 5 5	4 4 5	6 6 8	8 8.5 9	12 13 11	14 16 16	21 22 21	22 21 21	15 16 18	19 21 18	22 23 24
							40	3 10 20	3 2.5 2.5	4 3.5 3.5	5.5 5 5	3.5 4 3	5 5 5	7 7 8	10 11 9	12 14 13	17 20 17	17 24 17	12 14 13	17 18 18	21 25 26
							60	3 10 20	3 3 3	4 4 3.5	6 5 5	3 3.5 3	4 4.5 4	6 7 5.5	8 9 8	10 12 10	13 16 15	17 21 17	10 12 12	13 16 16	18 21 21
	SAM-07-05	FCS 07 & ACS 05					10	3 10 20	3 3 3	4 4 4	5 5 5	8 5 6	11 6.5 7	15 9 10	21 13 14	27 18 17	35 23 24				
							30	3 10 20	3 3 3	4 4 3.5	5.5 5 5	5.5 4.5 7	6 7 7.5	9 10 7.5	11 12 12	15 15 14	19 20 21	17 18 14	17 16 14	24 20 19	30 29 27
							40	3 10 20	3 3 3	4 3.5 3	6 5 5	4 4.5 3.5	6 7 6	8 7.5 6	9 9 7	11 12 10	15 15 14	19 20 21	17 16 14	17 16 14	24 20 19
							60	3 10 20	3 3 2.5	4 4 3	6 6.5 5	4 5 3.5	6 6.5 4.5	8 7.5 6	9 10 7	12 13 14	16 17 15	17 17 15	14 13 12	14 13 16	17 17 24

Spray angle performance varies with pressure. Contact BETE for specific data on critical applications.

SpiralAir®



1 1/2" SA (Set-up #) - A - 00

High-Flow Air Atomizing

DESIGN FEATURES

- A two-fluid nozzle using any gas as the atomizing fluid
- Three-stage atomization for highest performance
- Designed for high reliability in extremely hostile environments
- Efficient design reduces compressed air consumption

SPRAY CHARACTERISTICS

- Spray patterns:** Full Cone and Flat Fan
Spray angles: 20°, 60°, 90°
 (Other angles available by special order)
Flow rates: 0.33 to 26 gpm



Narrow Round 20°

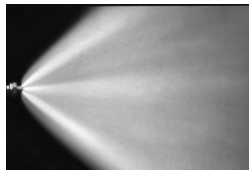

Wide Round 90°



Flat Fan 60°

Dimensions are approximate. Check with BETE for critical dimension applications.

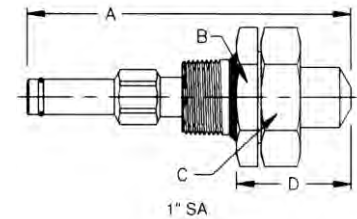

1" SA (Set-up #) - A - 00

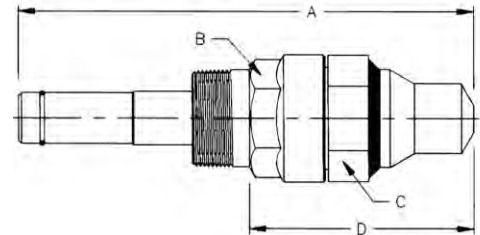

1 1/2" SA (Set-up #) - A - 00

Larger sizes and flow rates available upon request.

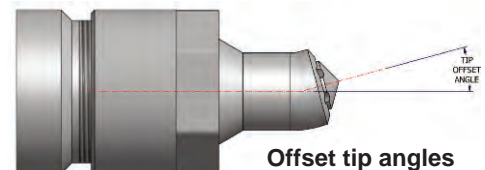
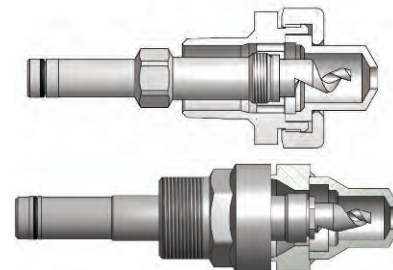

Offset tip angles available upon request

SpiralAir Spray Set-up, Spiral Tip and Dimensions

Pipe Size	Spray Set-up Number	Spiral Tip No.	Spray Angle	Spray Type	Approx. Free Pass. Dia. (in.)	Dimensions (in.)				Wt. (lbs)	
						A	B	C	D		
1"	SA 101	14	20°	Narrow Round	0.19	1	5.83	2.00	2.00	2.00	1.4
	SA 308		90°	Wide Round	0.106						
	SA 310		60°	Round	0.106						
	SA 402	20	90°	Flat Fan	0.166						
	SA 404		60°		0.166						
	SA 103	20	20°	Narrow Round	0.281						
	SA 307		90°	Wide Round	0.137						
	SA 309		60°	Round	0.137						
SA 401	90°		Flat Fan	0.205							
SA 403	60°			0.205							
1 1/2"	SA 2001	24	20°	Narrow Round	0.365	1 1/2	9.00	2.00	2.19	4.45	3.3
	SA 2008		90°	Wide Round	0.213						
	SA 2012		60°	Round	0.213						
	SA 2100	28	20°	Narrow Round	0.365						
	SA 2300		90°	Wide Round	0.213						
	SA 2301		60°	Round	0.213						

Standard Materials: 316 Stainless Steel with optional Cobalt Alloy 6 wear components.

Spray angle performance varies with pressure. Contact BETE for specific data on critical applications.

AIR ATOMIZING

TO ORDER: specify pipe size, body style, spray set-up #, hardware and mounting assemblies, and material.

The SpiralAir can be configured to fit any installation requirement. The examples shown are just a few of the custom assemblies available. For more information, contact BETE Applications Engineering.

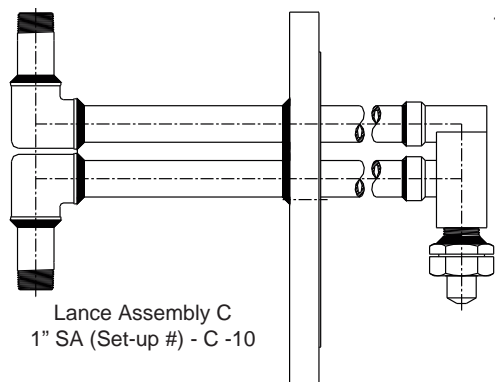
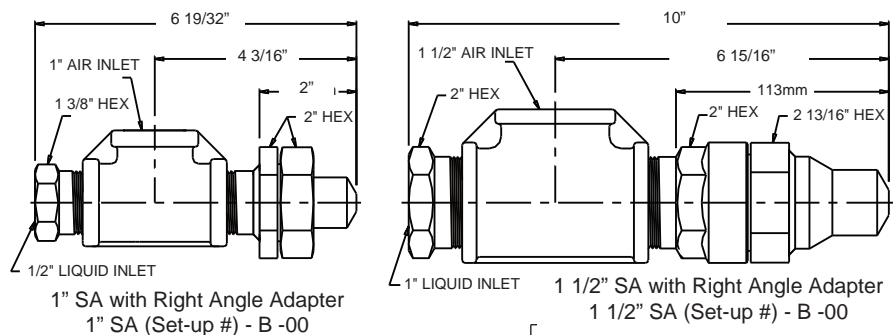

Lance Assembly C
1" SA (Set-up #) - C -10

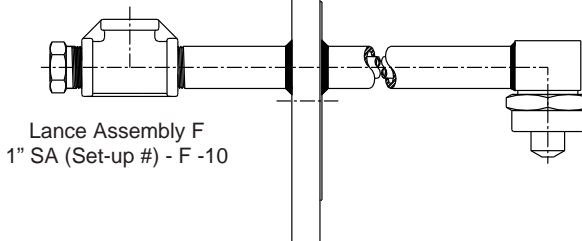

Lance Assembly F
1 1/2" SA (Set-up #) - F -10

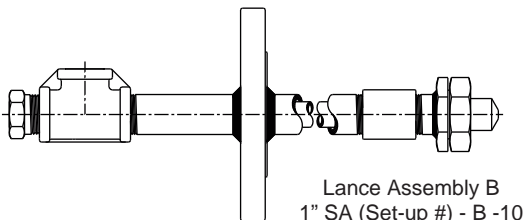

Lance Assembly B
1" SA (Set-up #) - B -10

Because very small variations in liquid pressure produce large variations in liquid flow, BETE recommends using a metering pump or other flow metering device to control the liquid flow.

AIR ATOMIZING

Call for the name of your nearest BETE representative.
CALL 413-772-0846

SpiralAir Set-up Flow Rates
Narrow, Wide and Flat Fan Patterns 1" and 1 1/2" Pipe Size

Pipe Size	Spiral Tip Rating	30 PSI Air			40 PSI Air			50 PSI Air			60 PSI Air			70 PSI Air			80 PSI Air			90 PSI Air			100 PSI Air																										
		GPM	PSI liquid	SCFM	GPM	PSI liquid	SCFM	GPM	PSI liquid	SCFM	GPM	PSI liquid	SCFM	GPM	PSI liquid	SCFM	GPM	PSI liquid	SCFM	GPM	PSI liquid	SCFM	GPM	PSI liquid	SCFM																								
1"	14	0.33	26	37	0.33	34	52	0.33	44	68	0.33	53	85	0.33	64	103	0.33	75	121	0.33	86	139	0.33	98	158	0.66	28	24	0.66	37	34	0.66	46	45	0.66	56	56	0.66	67	68	0.66	78	79	0.66	90	92	0.66	102	104
		1.00	30	19	1.00	39	27	1.00	48	35	1.00	58	44	1.00	69	53	1.00	80	62	1.00	92	71	1.00	104	81	1.33	31	16	1.33	40	22	1.33	50	30	1.33	60	37	1.33	71	44	1.33	82	52	1.33	94	60	1.33	106	68
		1.66	32	14	1.66	41	20	1.66	51	26	1.66	61	32	1.66	72	39	1.66	83	45	1.66	95	52	1.66	107	59	2.00	33	12	2.00	42	18	2.00	52	23	2.00	62	29	2.00	73	35	2.00	85	41	2.00	96	47	2.00	109	53
		2.33	34	11	2.33	43	16	2.33	53	21	2.33	63	26	2.33	74	31	2.33	86	37	2.33	98	43	2.33	110	48	2.66	35	10	2.66	44	15	2.66	54	19	2.66	64	24	2.66	75	29	2.66	87	34	2.66	99	39	2.66	111	45
		3.00	35	10	3.00	45	14	3.00	55	18	3.00	65	22	3.00	76	27	3.00	88	32	3.00	100	37	3.00	112	42	1.0	27	38	1.0	34	52	1.0	42	65	1.0	51	79	1.0	59	92	1.0	69	106	1.0	78	120	1.0	88	133
		2.0	29	27	2.0	37	36	2.0	45	45	2.0	54	55	2.0	63	64	2.0	72	74	2.0	82	84	2.0	92	93	3.0	31	22	3.0	39	29	3.0	47	37	3.0	56	45	3.0	65	52	3.0	75	60	3.0	84	68	3.0	94	76
		4.0	33	19	4.0	41	25	4.0	49	32	4.0	58	38	4.0	67	45	4.0	76	52	4.0	86	58	4.0	96	65	5.0	35	17	5.0	42	22	5.0	51	28	5.0	59	34	5.0	69	40	5.0	78	46	5.0	88	52	5.0	98	58
		6.0	35	15	6.0	43	20	6.0	52	26	6.0	61	31	6.0	70	36	6.0	79	42	6.0	89	47	6.0	100	53	7.0	36	14	7.0	44	19	7.0	53	24	7.0	62	29	7.0	71	34	7.0	81	39	7.0	91	44	7.0	101	49
		8.0	37	13	8.0	45	18	8.0	54	22	8.0	63	27	8.0	72	31	8.0	81	36	8.0	92	41	8.0	102	45	9.0	38	12	9.0	46	17	9.0	55	21	9.0	64	25	9.0	73	30	9.0	83	34	9.0	93	38	9.0	103	43
		10	39	12	10	47	16	10	56	20	10	65	24	10	74	28	10	84	32	10	94	36	10	104	41	5.0	39	87	5.0	49	106	5.0	59	127	5.0	68	152	5.0	78	181	5.0	87	213	5.0	95	248			
1 1/2"	24	8.0	42	68	8.0	53	83	8.0	62	101	8.0	72	122	8.0	82	145	8.0	91	173	8.0	91	173	8.0	100	203	11	47	53	11	57	66	11	67	80	11	77	98	11	86	118	11	96	141	11	105	168			
		14	48	30	13	57	42	13	66	55	13	76	70	13	86	86	13	97	103	13	108	121	14	48	28	14	57	39	14	67	52	14	77	66	14	87	81	14	98	97	14	109	114						
		15	49	27	15	58	37	15	67	49	15	77	63	15	88	77	15	98	92	15	109	108	16	50	25	16	59	36	16	68	47	16	78	60	16	88	73	16	99	88	16	110	103						
		17	50	24	17	59	34	17	69	45	17	79	57	17	89	70	17	100	84	17	111	98	18	51	23	18	60	32	18	69	43	18	79	54	18	90	67	18	100	80	18	111	94						
		19	51	22	19	60	31	19	70	41	19	80	52	19	90	64	19	101	77	19	112	90	20	52	21	20	61	30	20	70	40	20	80	50	20	91	62	20	102	74	20	113	87						
		12	47	31	12	56	44	12	65	59	12	75	74	12	85	91	12	96	109	12	107	128	13	48	30	13	57	42	13	66	55	13	76	70	13	86	86	13	97	103	13	108	121						
		13	48	30	13	57	42	13	66	55	13	76	70	13	86	86	13	97	103	13	108	121	14	48	28	14	57	39	14	67	52	14	77	66	14	87	81	14	98	97	14	109	114						
		14	48	28	14	57	39	14	67	52	14	77	66	14	87	81	14	98	97	14	109	114	15	49	27	15	58	37	15	67	49	15	77	63	15	88	77	15	98	92	15	109	108						
		15	49	27	15	58	37	15	67	49	15	77	63	15	88	77	15	98	92	15	109	108	16	50	25	16	59	36	16	68	47	16	78	60	16	88	73	16	99	88	16	110	103						
		16	50	25	16	59	36	16	68	47	16	78	60	16	88	73	16	99	88	16	110	103	17	50	24	17	59	34	17	69	45	17	79	57	17	89	70	17	100	84	17	111	98						
		17	50	24	17	59	34	17	69	45	17	79	57	17	89	70	17	100	84	17	111	98	18	51	23	18	60	32	18	69	43	18	79	54	18	90	67	18	100	80	18	111	94						
		18	51	23	18	60	32	18	69	43	18	79	54	18	89	67	18	100	80	18	111	94	19	51	22	19	60	31	19	70	41	19	80	52	19	90	64	19	101	77	19	112	90						
19	51	22	19	60	31	19	70	41	19	80	52	19	90	64	19	101	77	19	112	90	20	52	21	20	61	30	20	70	40	20	80	50	20	91	62	20	102	74	20	113	87								

Standard Materials: 316 Stainless Steel with optional Cobalt Alloy 6 wear components.

Spray angle performance varies with pressure. Contact BETE for specific data on critical applications.

CHOOSING A TANK WASHING NOZZLE

Adequate coverage and effective scrubbing are of prime importance in equipment and tank washing. When selecting BETE nozzles, you should consider the following vessel characteristics and nozzle design criteria: size and shape of the vessel, internals, vessel opening, type of residue to remove, and spray coverage.

Size and Shape of the Vessel to Clean

BETE's tank washing nozzles can be used to clean, wash, and rinse every size vessel from small bottles to a wide variety of process tanks and railroad tankers.

The HydroWhirl® S and TW series' offer the best options for cleaning small bottles, kegs, and barrels due to their compact design.

The free passage of the HydroClaw® is an ideal solution for small tanks up to 10 ft where clogging can lead to downtime. Medium-sized tanks up to 20 ft are best cleaned using the HydroWhirl® S, or the more chemical resistant HydroWhirl® Poseidon® up to 25 ft.

Where higher impact for hard to clean residues or coverage distance for large tanks is needed, BETE's tank washing machines, the HydroWhirl® Orbitor 100 and HydroWhirl® Orbitor, are an excellent choice.

Tank Washing Nozzles	Tank Diameter (Coverage)											
	5'	10'	15'	20'	25'	30'	40'	50'	60'	70'	80+	
Feet	5'	10'	15'	20'	25'	30'	40'	50'	60'	70'	80+	
Meters	2	3	4	5	7	9	12	15	18	21	24+	
HydroClaw		10'/3.0m										
TW			12'/3.6m									
CLUMP			16'/4.9m									
LEM			16'/4.9m									
HydroWhirl S				18'/5.5m								
HydroWhirl Poseidon					25'/7.6m							
HydroWhirl Orbitor 100								55'/17m				
HydroWhirl Orbitor												130'/40m



What is ATEX (Ex)?

ATEX is an acronym that stands for 'ATmosphere EXplosible'.

BETE products are reviewed and approved under ATEX Directive 2014/34/EU concerning equipment and protective systems intended for use in potentially explosive atmospheres.

All HydroWhirl Orbitor, HydroWhirl Orbitor 100, and HydroWhirl S nozzles are available with ATEX approval.

Visit www.hydrowhirl.com for more information on our tank washing nozzles.

HydroWhirl® S

Tank Washing - Slotted Spray Nozzle

DESIGN FEATURES

- Cleans more quickly, and uses less water, spray media, or fluid and lower pressure than static tank washers
- Surface finish of 0.8 µm (microns) R_a or better: ideal for sanitary applications
- Laser-welded design for durability
- Stainless steel construction – corrosion-resistant material
- Connections: threaded, clip-on, and welded
- Made from FDA compliant materials for use in Clean-In-Place (CIP) applications

SPRAY CHARACTERISTICS

- Self-cleaning bearings
- Vigorous moving spray action
- Spray Angles: 360°, 90° Down*, 180° Up*, 180° Down, 270° Up, 270° Down, *Not available in all flow rates.

Flow rates: 1.26 to 90.9 gpm

All HydroWhirl S nozzles are available with ATEX approval for Zone 0.



STANDARD CONNECTION SIZES Additional connection sizes available on request

Connection Type	Nozzle Number														
	HWS-20-3 HWS-20-4 HWS-20		HWS-30-5 HWS-30-6 HWS-30		HWS-40-7.5 HWS-40-8 HWS-40-9 HWS-40			HWS-40HF-11 HWS-40HF		HWS-50-16 HWS-50					
FNPT/G	-	1/4"	-	-	1/2"	-	1/2"	-	1"	-	-	-			
Pipe Clip On	1/8"	-	-	3/8"	-	-	3/4"	-	-	3/4"	-	-	1-1/4"	1-1/2"	-
Pipe Weld	-	1/4"	1/4"	-	1/2"	1/2"	-	1"	1/2"	-	1"	1"	-	-	2"
Dim F (in)	0.41	0.54	0.54	0.68	0.84	0.84	1.05	1.32	0.84	1.05	1.32	1.32	1.66	1.90	2.38
Tube Clip On	-	-	-	-	-	-	-	-	-	-	-	-	-	-	-
Tube Weld	3/8"	1/2"	3/8"	1/2"	3/4"	3/4"	1"	-	3/4"	1"	-	1"	1-1/4"	1-1/2"	2"
Dim F (in)	0.38	0.50	0.38	0.5	0.75	0.75	1.00	-	0.75	1.00	1.00	1.00	1.25	1.5	2.00
DIN Clip On**	DN8	-	-	-	-	-	-	-	-	-	-	-	-	-	-
DIN Weld**	-	DN10	DN10	DN15	DN15	DN20	DN25	DN15	DN20	DN25	DN40	DN50	-	-	-
Dim F (mm)	10	13	13	19	19	23	29	19	23	29	41	53	-	-	-

Optimal cleaning performance achieved between 30-50 PSI; maximum operating pressure is 150 PSI.

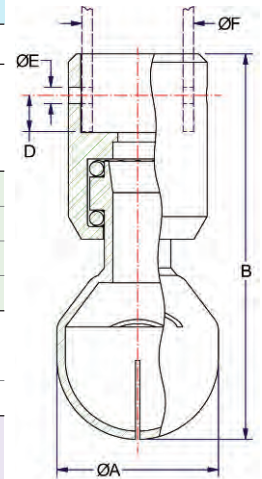

Threaded and Clip On Connections

HydroWhirl S Flow Rates* and Dimensions

Nozzle Number	GALLONS PER MINUTE @PSI						Dimensions (in)					Wt (oz)	Coverage Diameter (ft) @40 PSI
	10 PSI	20 PSI	30 PSI	40 PSI	50 PSI	60 PSI	A	B (NPT) B (G)	C	D (MAX)	E		
HWS-20-3	1.26	1.63	1.89	2.10	2.28	2.44	0.66	1.68	2.72	0.15	.086	0.88	4.9
HWS-20-4	2.14	2.79	3.26	3.64	3.97	4.26		1.96					
HWS-20	3.16	4.31	5.45	6.41	7.16	7.83							
HWS-30-5	2.31	3.29	4.12	4.80	5.37	5.88	1.1	2.38	3.28	0.21	.086	3.28	8
HWS-30-6	5.54	6.97	7.98	8.78	9.46	10.1		2.62					
HWS-30	5.70	8.10	9.96	11.5	12.9	14.3							
HWS-40-7.5	5.60	7.87	9.60	11.1	12.4	13.6	1.53	3.65	4.25	0.35	.156	10.8	11
HWS-40-8	6.39	8.96	10.9	12.6	14.1	15.4		3.94					
HWS-40-9	7.94	11.3	13.9	16.0	17.8	19.6							
HWS-40	9.08	13.1	16.1	18.3	20.3	22.2							
HWS-40HF-11	12.2	17.1	20.8	24.1	26.9	29.4	1.53	3.65	4.25	0.35	.156	10.6	13
HWS-40HF	15.0	21.3	26.0	29.7	32.6	35.4		3.94					
HWS-50-16	24.2	33.8	41.4	47.8	53.4	58.5	2.72	6.21	7.09	0.35	.219	53.8	18
HWS-50	37.2	52.4	64.1	74.2	82.9	90.9		6.47					

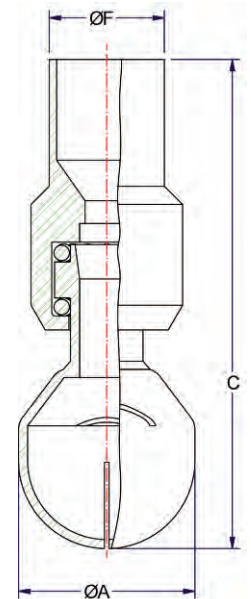

Weld On Connections

Standard Materials: Nozzle: 316L Stainless Steel; Ball Bearings: 316 Stainless Steel

*Flow rates represent threaded connections with a 360° spray angle.

**Flow rates may vary for other connection types and spray angles.

**Per DIN 11866 Part A)

HydroWhirl® Poseidon®



Tank Washing - PTFE Spray Nozzle

DESIGN FEATURES

- Cleans more quickly and uses less water, spray media, or fluid and lower pressure than static tank washers
- PTFE construction:
 - Ideal for harsh chemical environments
 - Corrosion resistant
- Available in threaded, pipe, tube, or DIN clip-on connections
- Made from FDA compliant materials for use in Clean-In-Place (CIP) applications

SPRAY CHARACTERISTICS

- Slow spinning produces longer spray dwell time on the target surface, increasing impact over conventional rotating designs
- Complete 360° omnidirectional spray pattern, other spray angels available upon request

Flow rates: 4.45 to 82.4 gpm

TANK WASHING

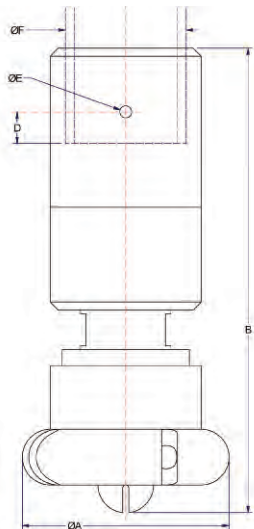

STANDARD CONNECTION SIZES

Connection Type	Nozzle Number											
	HWP-10			HWP-23 HWP-28			HWP-32 HWP-37			HWP-48 HWP-55 HWP-65 HWP-73		
FNPT/BSP	1/4"	3/8"	1/2"	3/8"	1/2"	3/4"	1/2"	3/4"	1"	1"	1-1/4"	1-1/2"
Pipe Clip-On							X					
Dim F (in)	0.54	0.68	0.84	0.68	0.84	1.05	0.84	1.05	1.32	1.32	1.66	1.90
Tube Clip-On	1/2"	3/4"	3/4"	1"	1"	1"	1-1/4"	1-1/2"	1-3/4"			
Dim F (in)	0.50	0.75	0.75	1.00	1.00	1.00	1.25	1.50	1.75			
DIN Clip On**	DN10	DN15	DN15	DN20	DN20	DN20	DN25	DN25	DN25	DN40	DN40	DN40
Dim F (mm)	13	19	19	23	23	23	29	29	29	41	41	41

HydroWhirl Poseidon Nozzle Flow Rates* and Dimensions

Nozzle Number	Spray Angle	GALLONS PER MINUTE @PSI						Dimensions (in)				Wt (oz)	Coverage Diameter (ft) @40PSI
		10 psi	20 psi	30 psi	40 psi	50 psi	60 psi	A	B	D MAX	E		
HWP-10	360°	4.45	6.31	7.75	8.96	10.0	11.0	1.68	3.94	0.50	0.09	3	9
HWP-23		9.42	13.4	16.5	19.0	21.3	23.4	1.95	4.12	0.50	0.16	4	11
HWP-28		10.7	15.2	18.6	21.5	24.0	26.3						14
HWP-32		11.7	16.8	20.8	24.1	27.1	29.8	3.00	6.40	0.50	0.19	21	14
HWP-37		15.1	21.6	26.5	30.8	34.5	37.9						16
HWP-48		20.6	29.3	36.0	41.7	46.8	51.3	3.30	7.30	0.50	0.19	29	24
HWP-55		23.5	33.4	41.1	47.6	53.3	58.5						25
HWP-65		30.7	43.4	53.3	61.6	68.9	75.5						
HWP-73		33.4	47.4	58.2	67.2	75.2	82.4						

Standard Materials: Nozzle: PTFE; Retaining Clip: 316 stainless steel

*Flow rates represent threaded connections with a 360° spray angle. Flow rates may vary for other connection types and spray angles, please contact BETE for more information.

**Per DIN 11866 Part A / DIN 11850 Part B

www.BETE.com

TO ORDER: specify pipe size, connection type, nozzle number, spray angle, and material.

HydroWhirl® Orbitor

High Impact Rotary Tank Cleaning Machine

DESIGN FEATURES

- Easily field-serviced to reduce maintenance costs
- Minimum moving parts to extend operating life
- Self-cleaning; self-lubricating
- High-impact jets; orbital wash pattern = high efficiency cleaning process
- 2 or 4 nozzle configurations
- Male or female connections

SPRAY CHARACTERISTICS

- 360° wash pattern
180° patterns available on request
 - Variable cycle times
 - High impact cleaning
- Flow rates:** 21.5 - 160 gpm
Working Pressure: 45 - 145 psi

Materials:

Housing and Nozzle Head: 316L
Gears: PEEK + 316 SS
Bushings/Seals: Carbon Filled PTFE

Max. Working Temp.: 200 °F (95 °C)
Max. Ambient Temp.: 285 °F (140 °C)
Weight: 16.5 Lbs

Minimum opening size is 5" for either 2-nozzle or 4-nozzle standard-capacity model with jets vertically aligned.



All HydroWhirl Orbitor tank cleaning machines are available with ATEX approval.



Orbitor 2 nozzle spray pattern

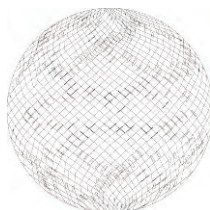

Orbitor 4 nozzle spray pattern

Jet lengths are effective cleaning lengths

# Nozzles X Orifice Size	4 X 4.2 mm			4 x 5 mm			4 x 6 mm			4 x 7 mm			4 x 8 mm		
	Flow (gpm)	Jet Length (ft)	Cycle Time (min)	Flow (gpm)	Jet Length (ft)	Cycle Time (min)	Flow (gpm)	Jet Length (ft)	Cycle Time (min)	Flow (gpm)	Jet Length (ft)	Cycle Time (min)	Flow (gpm)	Jet Length (ft)	Cycle Time (min)
45	22.6	9.5	11	31.4	13.1	13	38.6	17.4	15.5	59.1	21.3	11.4	68.3	23.6	15.5
60	26.5	9.8	9.3	36.4	13.8	10.8	45.7	18.7	12.9	67.7	23.3	9.8	79.0	26.2	12.9
75	30.0	11.5	7.9	40.8	15.4	9.4	52.1	20.3	11	75.2	25.3	8.7	88.4	29.5	11
90	33.3	13.1	6.9	44.8	17.1	8	58.0	23.0	9.5	81.9	27.9	8.1	96.9	32.5	9.5
100	35.3	16.4	6.3	47.2	20.7	7.3	61.8	26.2	8.4	86.0	30.8	7.5	102	34.8	8.5
115	38.1	20.3	5.8	50.8	24.6	6.8	67.0	30.8	7.6	91.9	33.8	7.1	110	36.7	7.8
130	40.8	23.3	5.6	54.0	27.9	6.5	72.1	33.8	7	97.3	36.7	6.9	117	40.0	7
145	43.4	25.6	5.5	57.2	29.5	6.4	76.8	36.7	6.9	102	39.4	6.6	123	42.6	6.9

# Nozzles X Orifice Size	2 x 6 mm			2 x 7 mm			2 x 8 mm			*2 x 10 mm			*2 x 12.5 mm		
	Flow (gpm)	Jet Length (ft)	Cycle Time (min)	Flow (gpm)	Jet Length (ft)	Cycle Time (min)	Flow (gpm)	Jet Length (ft)	Cycle Time (min)	Flow (gpm)	Jet Length (ft)	Cycle Time (min)	Flow (gpm)	Jet Length (ft)	Cycle Time (min)
45	21.5	18.0	33	26.1	21.3	37.5	33.5	23.6	25.7	59.1	32.1	41	89.4	33.1	26.8
60	25.4	19.7	27.2	31.3	23.6	31.6	39.3	26.2	22.9	68.7	34.4	34.2	103	36.7	24
75	28.8	20.7	24.7	36.0	25.9	28.2	44.4	29.5	20.5	77.2	37.7	30.5	115	39.7	21.7
90	31.9	23.0	22.6	40.4	27.9	25.8	49.1	32.5	18.9	84.9	41.7	28	126	44.0	19.8
100	33.9	26.2	21	43.2	29.2	24	52.0	34.8	17.5	89.8	45.6	26	133	48.5	18.4
115	36.7	29.5	19.5	47.2	30.2	22.3	56.2	36.7	16.4	96.6	49.9	24.5	143	53.8	17.2
130	39.4	33.5	18.4	51.1	37.0	21	60.1	40.0	15.6	103	55.8	23.2	152	60.0	16.3
145	41.9	37.7	17.4	54.7	40.4	20	63.8	42.6	14.9	109	61.7	22	160	65.9	15.5

TANK WASHING

CALL 413-772-0846
Call for the name of your nearest BETE representative.

HydroWhirl® Orbitor 100

High Impact Rotary Tank Cleaning Machine

DESIGN FEATURES

- Easily field-serviced to reduce maintenance costs
- Minimum moving parts to extend operating life
- Self-cleaning; self-lubricating
- High-impact jets; orbital wash pattern = high efficiency cleaning process
- Ideal for small to medium tanks, easily fits through Ø4" (100 mm) openings or Ø3.35" (85 mm) when nozzle head vertically aligned
- 4 nozzle configurations
- Female connections

SPRAY CHARACTERISTICS

- 360° wash pattern
 - Variable cycle times
 - High impact cleaning
- Flow rates:** 12 - 52.4 gpm
Working Pressure: 45 - 145 psi

Materials:

Housing and Nozzle Head: 316L
 Gears: PEEK + 316 SS
 Bushings/Seals: Carbon Filled PTFE

Max. Working Temp.: 200 °F (95 °C)
Max. Ambient Temp.: 285 °F (140 °C)
Weight: 5.5 Lbs



TANK WASHING



Orbitor 100

HydroWhirl Orbitor

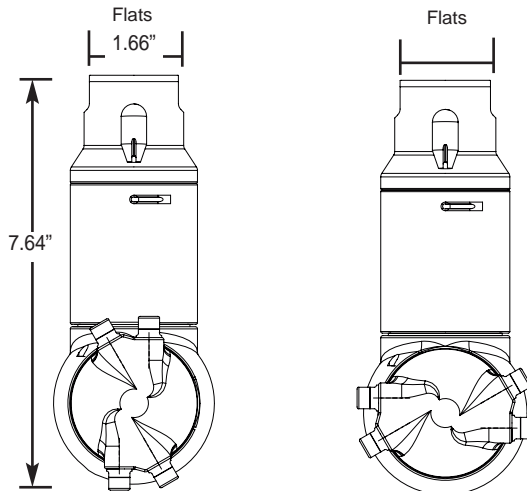

Vertical Nozzle Head Alignment
 Clearance Diameter: 3.35"

Horizontal Nozzle Head Alignment
 Clearance Diameter: 3.94"



All HydroWhirl Orbitor 100 tank cleaning machines are available with ATEX approval

Performance may vary with ATEX models.

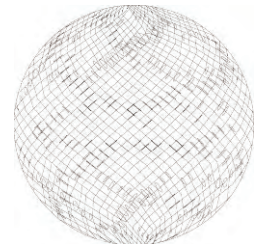

4 nozzle spray pattern

Jet lengths are effective cleaning lengths

# Nozzles X Orifice Size	4 x 3mm			4 x 4mm			4 x 5mm			4 x 6mm		
	Flow (gpm)	Jet Length (ft)	Cycle Time (min)	Flow (gpm)	Jet Length (ft)	Cycle Time (min)	Flow (gpm)	Jet Length (ft)	Cycle Time (min)	Flow (gpm)	Jet Length (ft)	Cycle Time (min)
45	12.0	12.5	6.0	17.8	14.4	5.4	23.7	16.4	4.4	30.6	18.0	3.9
60	13.9	14.9	5.4	20.3	17.1	4.7	26.7	19.1	3.9	34.0	20.6	3.4
75	15.8	17.0	4.8	22.7	19.4	4.1	29.6	21.4	3.4	37.3	22.9	3.0
90	17.6	18.8	4.3	25.1	21.3	3.6	32.3	23.2	3.0	40.6	24.7	2.6
100	18.8	19.8	4.0	26.6	22.3	3.3	34.1	24.3	2.8	42.8	25.7	2.4
115	20.5	21.0	3.6	28.9	23.6	2.9	36.7	25.4	2.4	46.0	26.9	2.1
130	22.2	22.0	3.2	31.2	24.5	2.7	39.1	26.2	2.2	49.2	27.8	1.9
145	23.9	22.6	2.9	33.4	25.0	2.5	41.4	26.6	2.0	52.4	28.2	1.7

TO ORDER: specify pipe size, connection type, nozzle number, spray angle, and material.

HydroClaw[®]

Tank Washing - Superior Clog Resistance

DESIGN FEATURES

- Patent-pending, clog-resistant design with no moving parts
- Allows passage of particles 1/4" in diameter, three times the free passage of a comparable spray ball
- Made from FDA compliant 316L stainless steel for use in food-grade and sanitary Clean-In-Place (CIP) applications
- Low pressure/high flow operation quickly cleans tank walls to reduce overall water consumption compared to a static spray ball
- Self-draining and self-flushing
- Laser-welded for durability
- Available in a variety of connection sizes and types, including threaded, clip-on and welded
- Clip-on nozzles include low-profile retaining pin for secure connection
- Fits through compact openings: either 2-1/2" (HC-42) or 3" (HC-100) diameter

SPRAY CHARACTERISTICS

- Vigorous rinsing action quickly flushes solids and contamination from vessels
- Complete 360° omnidirectional coverage
- Optimum cleaning performance at 30 psi
- Recommended installation 2 - 3 ft vertically below top of tank

Flow rates: 33 - 112 gpm

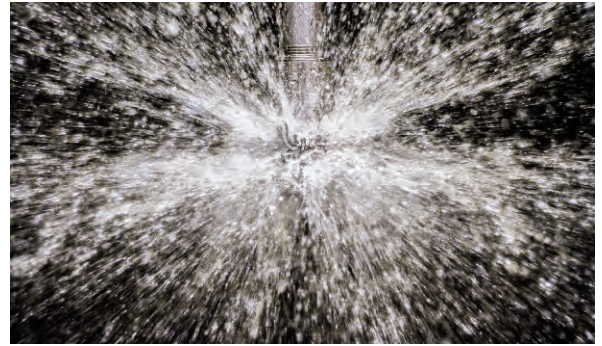
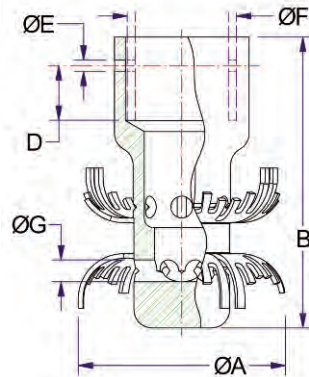

TANK WASHING

HydroClaw Flow Rates and Dimensions

Connection Type	Nozzle Number	GALLONS PER MINUTE @PSI				Dimensions (in)						Wt (oz)	Coverage Diameter (ft) @30 PSI
		25 PSI	30 PSI	35 PSI	40 PSI	A	B	D	E	F	Free Pass. G		
3/4" NPT	HC-42	33.4	36.6	39.5	42.0	2.38	3.59	-	-	-	0.25	15	8
G3/4												15	
1" Tube Weld-On												12	
1-1/2" Tube Clip-On	HC-42	35.7	38.9	42.0	44.8	2.38	3.59	0.75	0.16	-	0.25	18	8
1" Tube Clip-On												14	
DN20 Tube Clip-On*												15	
3/4" Pipe Clip-On												14	
1" NPT	HC-100	79.0	86.5	93.5	100	2.88	4.00	-	-	-	0.30	23	10
G1												23	
1-1/2" Tube Weld-On												15	
1-1/2" Tube Clip-On	HC-100	88.5	96.9	105	112	2.88	4.00	0.75	0.16	-	0.30	19	10
DN40 Tube Clip-On*												15	
1" Pipe Clip-On												21	

Standard Material: 316L Stainless Steel

Clip-on flow rates may vary depending on actual O.D. of installation tube or pipe

*Per DIN 11866 Part A / DIN 11850 Part B

TW

Tank Washing

DESIGN FEATURES

- Clog-resistant spiral design
- Energy efficient
- Compact design; fits small openings

SPRAY CHARACTERISTICS

- Easy to maintain
- Unique patterns that spray in opposing directions

Flow rates: 3.0 to 163 gpm

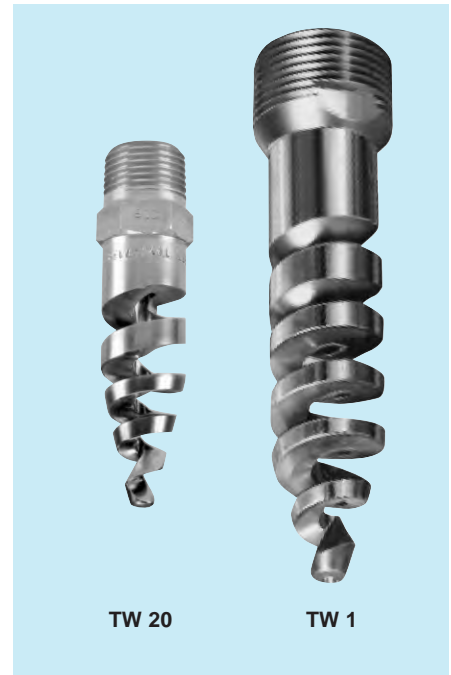

TW 20

TW 1

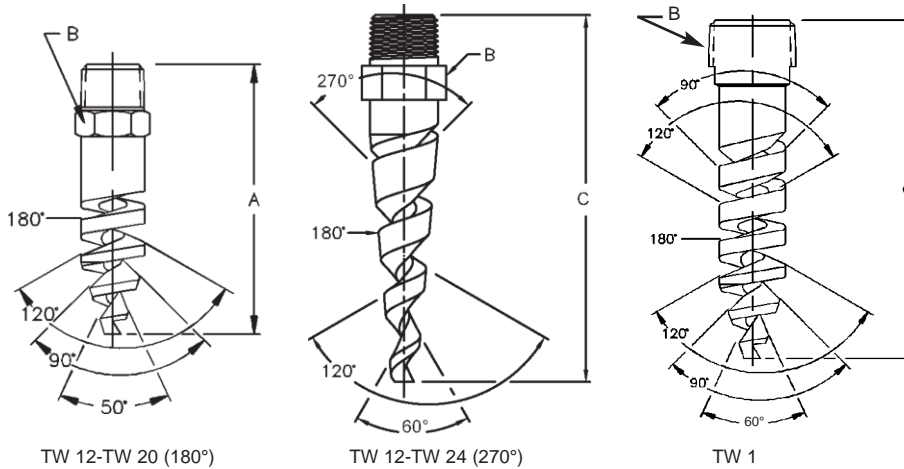

TW 12-TW 20 (180°)

TW 12-TW 24 (270°)

TW 1

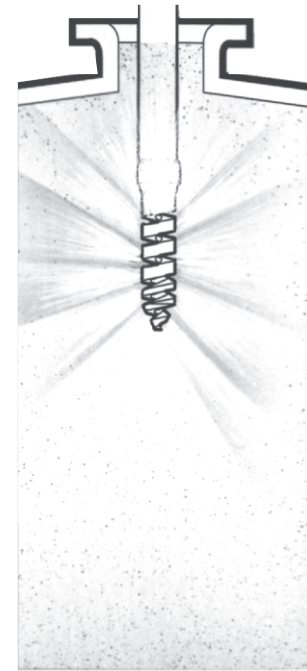

TANK WASHING

TO ORDER: specify pipe size, connection type, nozzle number, spray angle, and material.

Tank Washing TW Coverage Chart When spraying at 30-40 PSI

Pipe Size	Nozzle Number	Scrubbing Diameter (ft.)	Rinsing Diameter (ft.)
3/8	TW12	1.3	2.5
	TW14	1.5	4.0
	TW16	2.0	5.0
	TW20	3.0	7.0
1/2	TW24	4.0	9.0
1	TW1	8.0	20

Dimensions are approximate. Check with BETE for critical dimension applications.

Tank Washing Flow Rates and Dimensions TW 180° and 270°, 3/8", 1/2", and 1" Pipe Sizes

Male Pipe Size	Nozzle Number	Available Spray Angle	K Factor	GALLONS PER MINUTE @ PSI											Approx. (in.)		Dimensions (in.)			Wt. (oz.)
				10 PSI	20 PSI	30 PSI	40 PSI	50 PSI	60 PSI	80 PSI	100 PSI	200 PSI	400 PSI	Orifice Dia.	Free Pass. Dia.	A	B	C		
3/8	TW12	180° 270°	0.949	3.00	4.24	5.20	6.00	6.71	7.35	8.49	9.49	13.4	19.0	0.19	0.13	2.88	0.75	3.63	1.75	
	TW14	180° 270°	1.28	4.05	5.73	7.01	8.10	9.06	9.92	11.5	12.8	18.1	25.6	0.22	0.13					
	TW16	180° 270°	1.68	5.30	7.50	9.18	10.6	11.9	13.0	15.0	16.8	23.7	33.5	0.25	0.13					
	TW20	180° 270°	2.61	8.25	11.7	14.3	16.5	18.4	20.2	23.3	26.1	36.9	52.2	0.31	0.13					
1/2	TW24	270°	3.81	12.1	17.0	20.9	24.1	26.9	29.5	34.1	38.1	53.9	76.2	0.41	0.17	0.88	4.25	6.4		
1	TW1	270°	8.06	26.0	36.0	45.0	51.0	57.0	63.0	72.0	80.6	115	163	0.56	0.20	1.13	5.75	10.5		

Flow Rate (GPM) = K √PSI

Standard Materials: Brass, 316 Stainless Steel

CLUMP

Tank Washing Nozzles

DESIGN FEATURES

- Each nozzle in the stationary cluster is a BETE clog-resistant full cone nozzle of the MaxiPass® series
- Can be supplied with various other BETE nozzles for any desired application
- Female connection

SPRAY CHARACTERISTICS

- Spherical omnidirectional coverage
 - Six nozzles arranged in cluster to project spray in all directions
- Flow rates:** 7.52 to 80.6 gpm
(Special flow rates available)

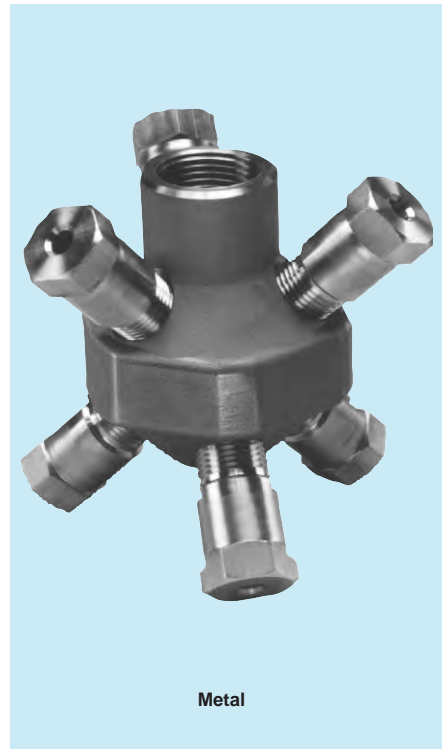

Metal

CLUMP Coverage Chart When spraying at 40-50 psi

Female Pipe Size	Nozzle Number	Scrubbing Diameter (ft.)	Rinsing Diameter (ft.)
3/4"	CLUMP125	4	8
	CLUMP156	4	12
	CLUMP187	6	14
1"	CLUMP187	6	14
	CLUMP218	8	14
	CLUMP250	10	16

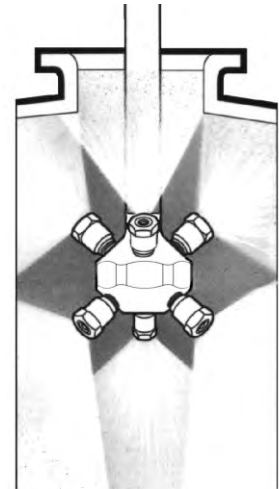
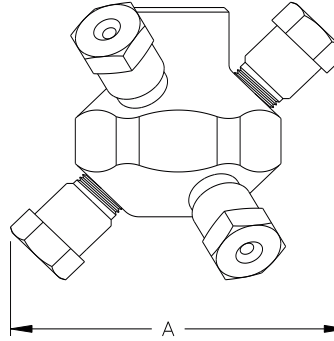

Typical CLUMP installation

Dimensions are approximate. Check with BETE for critical dimension applications.

CLUMP Flow Rates and Dimensions Spherical, 360° Spray Angle, 3/4" and 1" Pipe Size

Female Pipe Size	Nozzle Number	K Factor	GALLONS PER MINUTE @ PSI							Minimum Entrance Opening (in.) A	Weight (oz.)	
			10 PSI	15 PSI	20 PSI	30 PSI	40 PSI	60 PSI	80 PSI		Metal	Plas.
3/4"	CLUMP125	2.50	7.36	8.91	10.2	12.3	14.1	17.1	19.6	4.75	36.32	4.82
	CLUMP156	3.96	11.7	14.2	16.2	19.6	22.4	27.1	31.1			
	CLUMP187	5.72	16.9	20.4	23.4	28.3	32.4	39.2	44.9			
1"	CLUMP187	5.72	16.9	20.4	23.4	28.3	32.4	39.2	44.9	5.75	69.60	9.26
	CLUMP218	9.10	26.9	32.5	37.2	45.0	51.5	62.3	71.4			
	CLUMP250	10.30	30.3	36.7	42.0	50.8	58.2	70.4	80.6			

$$\text{Flow Rate (GPM)} = K (\text{PSI})^{0.47}$$

Standard Materials: 316 Stainless Steel and Brass. Other materials available on request.

Spray angle performance varies with pressure. Contact BETE for specific data on critical applications.

LEM

Tank Washing Nozzle

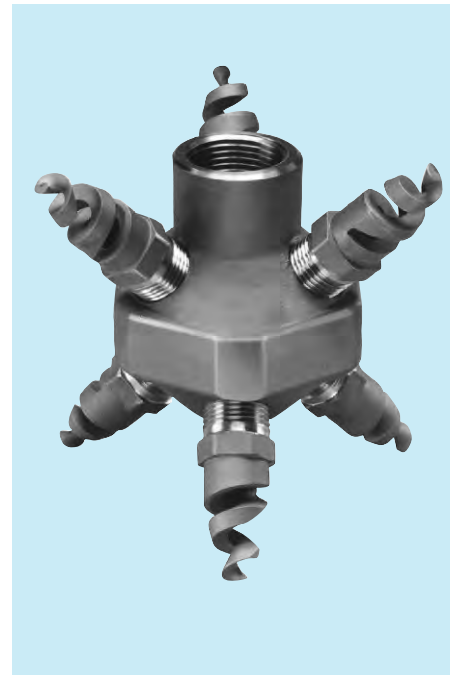

DESIGN FEATURES

- Each nozzle in the stationary cluster is a BETE clog-resistant spiral nozzle of the TF Series
- Can be supplied with various other BETE nozzles for any desired application
- Female connection

SPRAY CHARACTERISTICS

- Spherical omnidirectional coverage
 - Six nozzles arranged in cluster to project spray in all directions
- Flow rates:** 4.2 to 157 gpm (special flow rates available; special tips upon request)

TANK WASHING

LEM Coverage Chart

When Spraying at 40 - 50 PSI

Female Pipe Size	Nozzle Number	Scrubbing Diameter (ft.)	Rinsing Diameter (ft.)
3/4	LEM6	1.5	3.0
	LEM8	3.0	6.0
	LEM10	4.5	9.0
1	LEM12	6.5	13.0
	LEM14	6.8	13.5
	LEM16	7.2	14.5
	LEM20	8.0	16.0

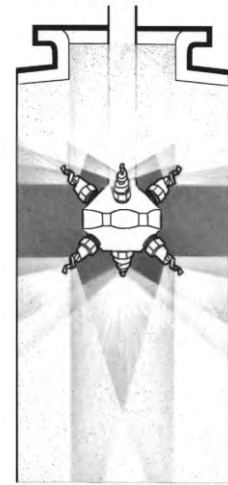
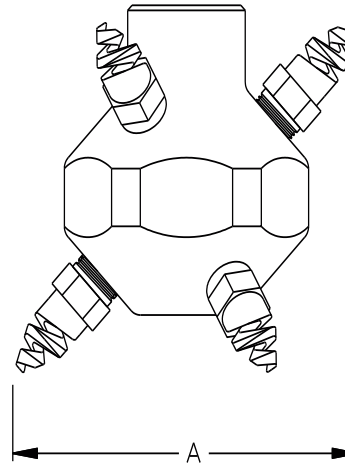

Typical LEM installation

Dimensions are approximate. Check with BETE for critical dimension applications.

LEM Flow Rates and Dimensions

Spherical, 360° Spray Angle, 3/4" and 1" Pipe Sizes

Female Pipe Size	Nozzle Number	K Factor	GALLONS PER MINUTE @ PSI							Minimum Entrance Open. (in.) A	Weight	
			10 PSI	20 PSI	30 PSI	40 PSI	60 PSI	80 PSI	100 PSI		(lbs.) Metal	(oz.) Plas.
3/4	LEM6	1.33	4.20	5.94	7.27	8.40	10.3	11.9	13.3	4.50	2.25	6.00
	LEM8	2.53	8.00	11.3	13.9	16.0	19.6	22.6	25.3			
	LEM10	3.95	12.5	17.7	21.7	25.0	30.6	35.4	39.5			
1	LEM12	5.69	18.0	25.5	31.2	36.0	44.1	50.9	56.9	5.25	4.13	11.0
	LEM14	7.68	24.3	34.4	42.1	48.6	59.5	68.7	76.8			
	LEM16	9.96	31.5	44.5	54.6	63.0	77.2	89.1	99.6			
	LEM20	15.7	49.5	70.0	85.7	99.0	121	140	157			

Flow Rate (GPM) = $K\sqrt{PSI}$

Standard Materials: Brass, 316 Stainless Steel, PVC and PTFE.

Spray angle performance varies with pressure. Contact BETE for specific data on critical applications.

TO ORDER: specify pipe size, connection type, nozzle number, spray angle, and material.

AFF



Fan 145°

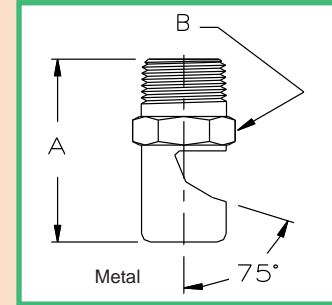

Fire Protection - Water Wall

DESIGN FEATURES

- One-piece construction
- Clog-resistant
- Durable
- Male connection

All 1/2" connection AFF nozzles require a main line strainer designed to entrap material 1/8" and larger.

SPRAY CHARACTERISTICS

- Extra-wide flat fan spray angle
- Medium-impact spray
- Spray discharge deflected 75° from inlet axis
- Coarse atomization

Spray pattern: Flat Fan

Flow rates: 6.72 - 69.7 gpm

AFF Flow Rates and Dimensions

Connection	Nozzle Number	K Factor	Pressure (psi)	Flow Rate (gpm)	Orifice (in)	Free Passage (in)	Dimensions (in)		Weight (oz)
							A	B	
1/2 "	1.18-145	1.18	50	8.34	0.209	0.209	2.00	0.88	4.13
			150	14.5					
	1.66-145	1.66	50	11.7	0.250	0.250			
			150	20.3					
	2.53-145	2.53	50	17.9	0.312	0.312			
			150	31					
	2.85-145	2.85	50	20.2	0.319	0.319			
			150	34.9					
3/4"	3.35-145	3.35	50	23.7	0.348	0.348	2.63	1.38	12.17
			150	41					
	4.43-145	4.43	50	31.3	0.406	0.406			
			150	54.3					
	5.69-145	5.69	50	40.2	0.453	0.453			
			150	69.7					

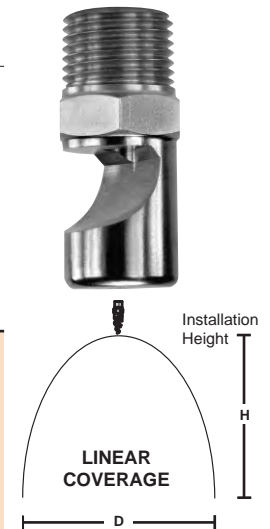

SPECIAL PURPOSE

AFF Spray Coverage Nozzle Spray Directed Vertically Down

Connection (Male Pipe Size)	Installation Height - H (ft)			1	2	3	4	5	6	7	8	9	10
	Nozzle Number	Pressure (PSI)	Measured Angle	Linear Coverage - D (ft) @ Installation Height - H (ft)									
1/2 "	1.18-145	50	144°	6.2	10.8	14.9	17.3	19.5	21.0	22.1	22.8	23.3	23.7
		150	148°	6.8	11.7	14.6	17.3	19.3	20.7	21.7	22.5	22.9	23.3
	1.66-145	50	140°	6.1	9.7	13.4	16.8	18.8	20.6	21.6	22.6	23.3	23.8
		150	141°	6.5	10.4	14.3	17.4	19.6	21.7	23.2	24.2	24.9	25.4
	2.53-145	50	140°	6.1	9.7	13.4	16.8	18.8	20.6	21.6	22.6	23.3	23.8
		150	139°	4.7	7.3	9.6	12.5	14.9	16.9	18.9	20.5	21.7	22.6
	2.85-145	50	152°	6.0	12.0	16.0	18.0	20.0	22.0	24.0	26.0	28.0	30.0
		150	152°	7.0	10.0	14.0	16.0	17.0	18.0	20.0	22.0	24.0	26.0
3/4"	3.35-145	50	139°	4.5	8.2	11.1	14.1	15.9	18.1	19.3	20.5	21.2	21.7
		150	128°	5.0	7.8	11.2	14.8	16.8	18.9	20.5	21.9	22.8	23.5
	4.43-145	50	134°	4.6	9.5	12.3	15.3	17.5	19.2	20.7	21.8	22.4	23.0
		150	135°	5.2	9.4	12.7	16.0	18.5	20.6	22.1	23.1	23.7	24.2
	5.69-145	50	136°	6.0	9.6	13.2	15.4	18.1	19.7	21.1	22.0	22.7	23.3
		150	135°	5.2	9.4	12.7	16.0	18.5	20.6	22.1	23.1	23.7	24.2

Standard Materials: Brass and 316 Stainless Steel.

$Flow Rate (GPM) = K (PSI)^{0.50}$

Call for the name of your nearest BETE representative.

CALL 413-772-2166

N

Fire Protection

DESIGN FEATURES

- Simplicity of design
- One-piece/no internal parts
- Clog-resistant
- Three standard pipe sizes—1/2", 1", and 1-1/2"
- Male connection
- Factory Mutual, U.S. Coast Guard, and Lloyd's Register approved models

SPRAY CHARACTERISTICS

- Two spray cones: an outer, wide angle cone and a narrower inner cone combine to give full cone effect

Spray pattern: Full Cone

Spray angles: 90° and 120° standard

Flow rates: 3.0 to 534 gpm



Nozzle with optional protective cover

Use of blow-off covers requires a pressure of 25 PSI or higher



Full Cone 90°



Full Cone 120° (W)

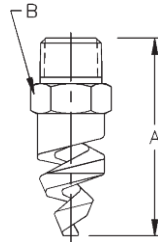

N6 nozzles protect a propane storage tank from fire and explosion.



N3-N5W: U.S. Coast Guard approved
TF24-150° also available in Factory Mutual approved model (see page 20)

Dimensions are approximate. Check with BETE for critical dimension applications.

N Flow Rates and Dimensions

Full Cone, Medium 90° and Wide 120° (W) Spray Angles, 1/2" to 1 1/2" Pipe Sizes

Male Pipe Size	Nozzle Number	K Factor	GALLONS PER MINUTE @ PSI									Approx. (in.)		Approximate Dimensions (inches)		Wt. (oz.) Metal
			10 PSI	20 PSI	30 PSI	40 PSI	60 PSI	80 PSI	100 PSI	200 PSI	400 PSI	Orifice Dia.	Free Pass. Dia.	A	B	
1/2	N1	0.949	3.00	4.24	5.20	6.00	7.35	8.49	9.49	13.4	19.0	0.19	0.13	2.50	0.88	3.00
	N2	1.68	5.30	7.50	9.18	10.6	13.0	15.0	16.8	23.7	33.5	0.27	0.13			
	N3	2.61	8.25	11.7	14.3	16.5	20.2	23.3	26.1	36.9	52.2	0.34	0.13			
	N4	3.81	12.1	17.0	20.9	24.1	29.5	34.1	38.1	53.9	76.2	0.43	0.19			
	N5	5.22	16.5	23.3	28.6	33.0	40.4	46.7	52.2	73.8	104	0.53	0.19			
	N6	6.64	21.0	29.7	36.4	42.0	51.4	59.4	66.4	93.9	133	0.56	0.19			
1	N6	6.64	21.0	29.7	36.4	42.0	51.4	59.4	66.4	93.9	133	0.60	0.19	3.63	1.38	8.50
	N7	10.6	33.5	47.4	58.0	67.0	82.1	94.8	106	150	212	0.77	0.25			
1 1/2	N8	15.0	47.5	67.2	82.3	95.0	116	134	150	212	300	0.93	0.25	4.38	2.00	27.0
	N9	20.4	64.5	91.2	112	129	158	182	204	288	408	1.09	0.31			
	N10	26.7	84.5	120	146	169	207	239	267	378	534	1.29	0.31			

$$\text{Flow Rate (GPM)} = K \sqrt{\text{PSI}}$$

Standard Nozzle Materials: Brass and 316 Stainless Steel

Available in nickel aluminum bronze and titanium, plus other materials available on request.

Standard Cover Materials: Brass for brass nozzles, 304 Stainless Steel for other nozzle materials

Spray angle performance varies with pressure.
 Contact BETE for specific data on critical applications.

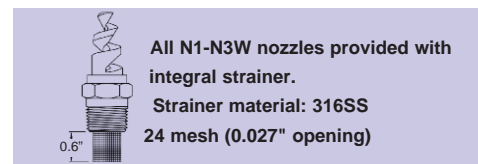

All N1-N3W nozzles provided with integral strainer.
 Strainer material: 316SS
 24 mesh (0.027" opening)

SPECIAL PURPOSE

TO ORDER: specify pipe size, connection type, nozzle number, and material.

TF29-180



FireBēter: Ultra-Wide Full Cone Coverage

DESIGN FEATURES

- Two-turn spiral
- Ultra-wide spray coverage very close to the nozzle
- One-piece design/no internal parts
- Excellent choice for deluge applications where there is little distance between nozzle and material being protected

SPRAY CHARACTERISTICS

- Wide spray coverage
- Fine atomization
- Spray patterns:** circular sheet with maximum coverage and excellent atomization
- Spray angle:** 180° extra-wide angle
- Flow rates:** 3.80 to 110 gpm

TF29-180 nozzles in brass can be supplied in full compliance with MIL-S-24660.

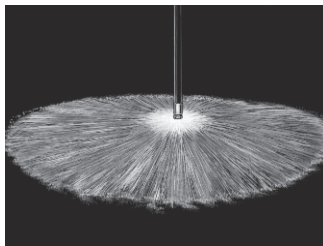

Full Cone 180°

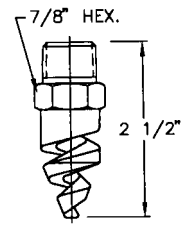
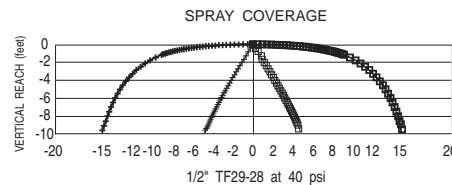
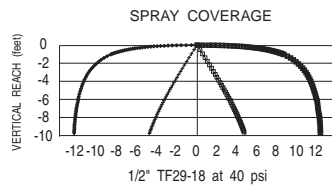

Dimensions are approximate. Check with BETE for critical dimension applications.

TF29-180 Flow Rates and Dimensions Extra-wide Spray Angle, 1/2" Pipe Size

Male Pipe Size	Nozzle Number	K Factor	GALLONS PER MINUTE @ PSI											Approx. Free Pass. & Orifice Dia. (in.)	Wt. (lbs)
			10 PSI	20 PSI	30 PSI	40 PSI	50 PSI	60 PSI	80 PSI	100 PSI	200 PSI	400 PSI			
1/2	TF29-180-16	1.20	3.80	5.37	6.58	7.60	8.50	9.31	10.7	12.0	17.0	24.0	0.203	0.14	
	TF29-180-18	1.90	6.00	8.49	10.4	12.0	13.4	14.7	17.0	19.0	26.8	37.9	0.250	0.14	
	TF29-180-21	2.29	7.25	10.3	12.6	14.5	16.2	17.8	20.5	22.9	32.4	45.9	0.281	0.22	
	TF29-180-24	3.00	9.50	13.4	16.5	19.0	21.2	23.3	26.9	30.0	42.5	60.1	0.328	0.18	
	TF29-180-28	3.91	12.4	17.5	21.4	24.7	27.6	30.3	34.9	39.1	55.2	78.1	0.375	0.16	
	TF29-180-32	5.50	17.4	24.6	30.1	34.8	38.9	42.6	49.2	55.0	77.8	110	0.438	0.14	

$$\text{Flow Rate (GPM)} = K \sqrt{\text{PSI}}$$

Standard Materials: Brass and 316 Stainless Steel.

Spray angle performance varies with pressure. Contact BETE for specific data on critical applications.

SPECIAL PURPOSE

CALL 413-772-0846
Call for the name of your nearest BETE representative.

Twist & Dry®

Twist & Dry Component System

The Twist & Dry® series of nozzles was designed and developed for the spray drying industry, with the dryer operator specifically in mind. The patented locking system locks the swirl and orifice components into place prior to installation on the spray lance, eliminating many of the hassles associated with replacing wear parts and allowing for easier installs. Through continuous development and innovation, BETE offers solutions for high pressure, high temperature, and abrasive media applications.

DESIGN FEATURES

- Product consistency
- Premium tungsten carbide disc available for extended wear life
- Hand tighten - no special tools required for assembly
- Easy to maintain
- Clog-resistant design
- 218SS body for anti-galling

SPRAY SET-UPS

The spray angle and flow rate of a Twist and Dry assembly is determined by the swirl and orifice combination. The Twist & Dry series has almost 1,000 different combinations of swirl and orifice discs to provide flow rates and spray angles that fit your needs. To locate the right swirl and orifice combination, refer to the following TD/TD-K and TDL pages.



TD swirl disc

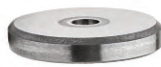

TD orifice disc

TD Series

The original TD series features BETE's innovative and patented locking lug feature, single piece thick swirl component, clog-resistant design, and multiple carrier options to provide ease of installation, operation, and maintenance.

- BETE's patented lug design
- Clog-resistant design

TDL Series

The TDL series offers a compact nozzle design that is ideal for small-scale applications and pilot testing.

- BETE's patented lug design
- Small-scale applications
- Pilot testing



TDL Assembly

TD-K High Pressure Design

The TD-K series incorporates a PEEK back-up ring and optional Duplex carrier to allow for operation in high-pressure applications. Higher operating pressures can help increase yield, saving time and money. The TD series includes:

- TD-7K: rated for 7,000 psi
- TD-10K: rated for 10,000 psi

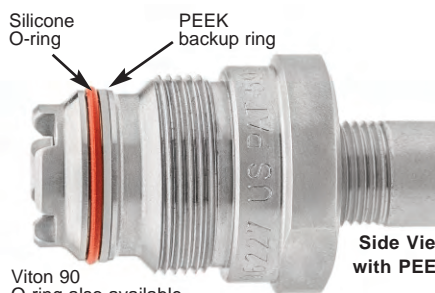

Viton 90 O-ring also available

High Temperature (HT) Design

The HT set-up utilizes a special body design and carrier #7 to replace the traditional O-ring seals with metal gaskets, allowing for operation at high temperatures.

- HT rated for 7,000 psi at 800 °F
- No O-rings



HT Assembly

TD/TD-K Drip Pro Check Valve

The TD Drip Pro check valve's patented design offers a high-flow solution to reduce drips which can lead to scorched particles and ruined product.

- Fits standard BETE carriers
- Replaces standard TD/TD-K bodies (except HT set-up)
- Drip-free operation
- Easy to assemble



Drip Pro Check Valve

Tungsten Carbide Options

Pro Grade	Suitable for most general spray drying applications
Premium Grade	Superior wear resistance for extremely abrasive spray media

Same day shipping for wear parts!

SPECIAL PURPOSE

TO ORDER: specify pipe size, connection type, nozzle number, and material. 413-772-0846

Twist & Dry® Components & Options

Talk to one of our engineers; we're here to help you find the right solution for your application.
413-772-0846

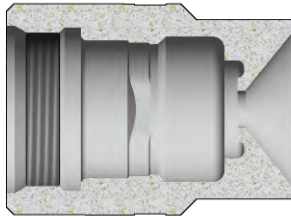

Durable Beard-Deterring

Carrier 1 (C11) (shown)
 Carrier 11 (C111) - without lug

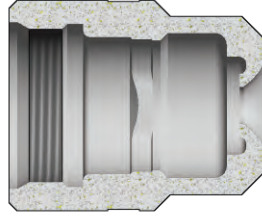

Standard Carrier

Carrier 2 (C12) (shown)
 Carrier 5 (C15) - without lug

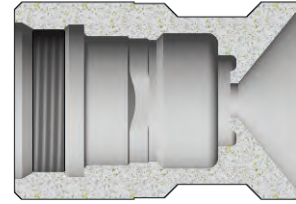

Knife Edge Anti-Bearding

Carrier 10 (C110) (shown)
 Carrier 12 (C112) - without lug

To Order: Spray Set-up Number

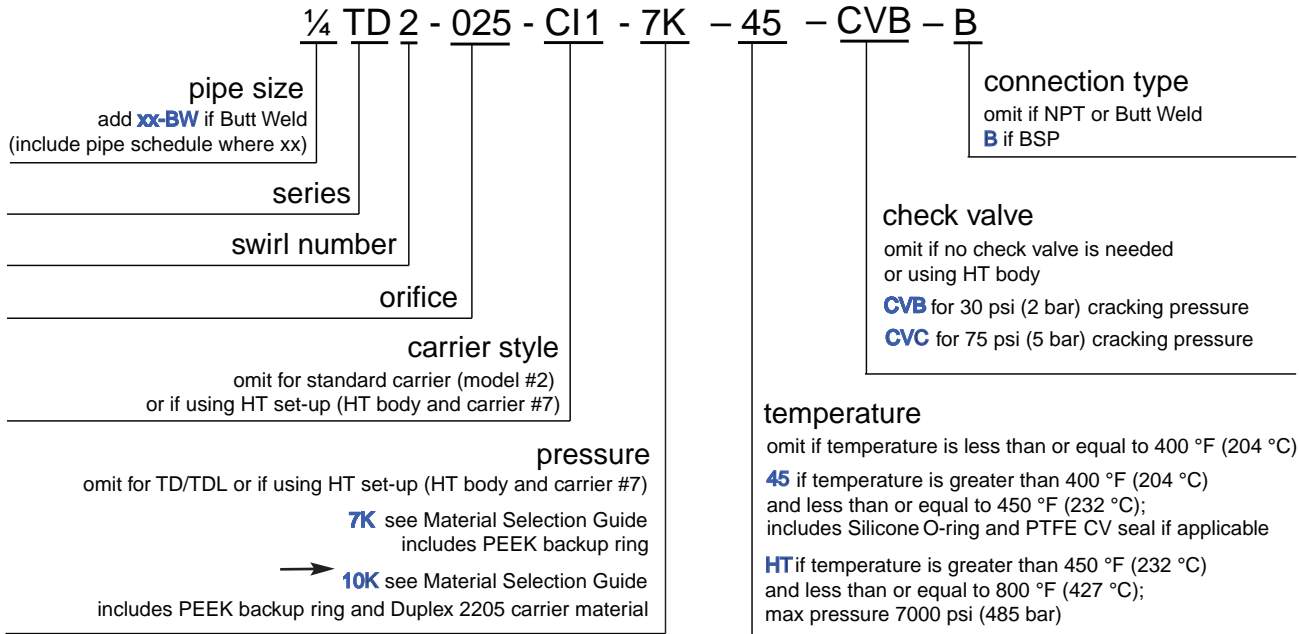

Twist & Dry Material Selection Guide

Pressure		Temperature			
psi	bar	up to 302 °F (150 °C)	up to 400 °F (204 °C)	up to 450 °F (232 °C)	up to 800 °F (427 °C)
10,000	690	10K Set-up Viton O-ring w/ PEEK Backup Ring Carrier in Duplex 2205	10K Set-up Viton O-ring w/ PEEK Backup Ring Carrier in Duplex 2205	10K Set-up Silicone O-ring w/ PEEK Backup Ring Carrier in Duplex 2205	HT Set-up Metal Gaskets High Temperature Body Carrier #7
		7K Set-up Viton O-ring w/ PEEK Backup Ring	7K Set-up Viton O-ring w/ PEEK Backup Ring	7K Set-up Silicone O-ring w/ PEEK Backup Ring	
5,000	345	TD/TDL Set-up Viton O-ring	TD/TDL Set-up Viton O-ring	TD/TDL Set-up Silicone O-ring	
3,500	240				
800	55				

SPECIAL PURPOSE

CALL 413-772-0846
 Call for the name of your nearest BETE representative.

TD/TD-K

Twist & Dry® Hollow Cone

DESIGN FEATURES

- Patented locking mechanism for quick and easy change-out and maintenance

High pressure applications:

- TD-K with PEEK backup ring
- HT body with Carrier #7

High temperature applications:

- TD/TD-K bodies with silicone O-ring
- HT body with Carrier #7
- Female pipe thread or butt-weld connections
- Hand tighten, no special tools required
- Orifice size: 0.034" through 0.157"
- Interchangeable swirl and orifice discs for variable patterns and flow rates

- Drip Pro check valve available upon request
- **Multiple grades of tungsten carbide to suit application needs**

- Same day shipping of wear parts
- Clog-resistant design
- Easy to maintain

SPRAY CHARACTERISTICS

- Spray pattern:** Hollow Cone
- Flow rates:** 8.94 to 2,210 gph
- Spray angle:** 50° through 85°, as listed



TD Assembly



70° Hollow Cone



Cutaway view of carrier showing BETE's unique locking lug feature

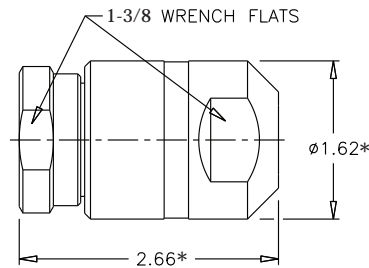

Pipe Size	Weight* (oz.)
1/4"	19
3/8"	18.5
1/2"	18
3/4"	17

Dimensions are approximate. Check with BETE for critical dimension applications.

Twist & Dry/TD-K Flow Rates

Hollow Cone; 50° - 85° Spray Angles; 1/4", 3/8", 1/2", and 3/4" Pipe Sizes; NPT, BSP, or Weld Prep

Female Pipe Size	Nozzle Number	Spray Angle	Orifice Swirl Dia. (in.)	K Factor	GALLONS PER HOUR @ PSI											Use TD-K for operation over 3,500 psi		
					200 PSI	500 PSI	750 PSI	1000 PSI	1250 PSI	1500 PSI	1750 PSI	2000 PSI	2500 PSI	3000 PSI	4000 PSI	7000 PSI	10,000 PSI	
1/4"	TD2-34	70°	SW2 0.034	0.632	8.94	14.1	17.3	20.0	22.4	24.5	26.5	28.3	31.6	34.6	40.0	52.9	63.2	
	TD1-37	80°	SW1 0.037															
1/4"	TD2-40	75°	SW2 0.040	0.791	11.2	17.7	21.7	25.0	28.0	30.6	33.1	35.4	39.5	43.3	50.0	66.2	79.1	
	TD1-49	85°	SW1 0.049															
1/4"	TD4-34	60°	SW4 0.034	0.949	13.4	21.2	26.0	30.0	33.5	36.7	39.7	42.4	47.4	52.0	60.0	79.4	94.9	
	TD3-40	70°	SW3 0.040															
OR 3/8"	TD5-34	50°	SW5 0.034	1.11	15.7	24.7	30.3	35.0	39.1	42.9	46.3	49.5	55.3	60.6	70.0	92.9	111	
	TD4-40	65°	SW4 0.040															
OR 3/8"	TD4-43	65°	SW4 0.043	1.26	17.9	28.3	34.6	40.0	44.7	49.0	52.9	56.6	63.2	69.3	80.0	105	126	
	TD3-49	75°	SW3 0.049															
OR 1/2"	TD6-37	50°	SW6 0.037	1.42	20.1	31.8	39.0	45.0	50.3	55.1	59.5	63.6	71.2	77.9	90.0	119	142	
	TD5-40	60°	SW5 0.040															
	TD4-46	70°	SW4 0.046															
	TD3-55	75°	SW3 0.055															
OR 3/4"	TD6-40	50°	SW6 0.040	1.58	22.4	35.4	43.3	50.0	55.9	61.2	66.1	70.7	79.1	86.6	100	132	158	
	TD5-43	60°	SW5 0.043															
	TD4-52	70°	SW4 0.052															
	TD5-49	60°	SW5 0.049															
OR 3/4"	TD4-58	70°	SW4 0.058	1.74	24.6	38.9	47.6	55.0	61.5	67.4	72.8	77.8	87.0	95.3	110	146	174	
	TD3-67	80°	SW3 0.067															

$$\text{Flow Rate (GPH)} = K \sqrt{\text{PSI}}$$

Standard Materials: Carrier: Stainless Steel, Duplex; Body: Stainless Steel; Swirl/Orifice: Tungsten Carbide

Spray angle performance varies with pressure. Contact BETE for specific data on critical applications.

SPECIAL PURPOSE

TO ORDER: specify pipe size, connection type, nozzle number, and material. 413-772-0846

Twist & Dry/TD-K Flow Rates

Hollow Cone; 50° - 85° Spray Angles; 1/4", 3/8", 1/2", and 3/4" Pipe Sizes; NPT, BSP, or Weld Prep

Female Pipe Size	Nozzle Number	Spray Angle	Swirl	Orifice Dia. (in.)	K Factor	GALLONS PER HOUR @ PSI										Use TD-K for operation over 3,500 psi		
						200 PSI	500 PSI	750 PSI	1000 PSI	1250 PSI	1500 PSI	1750 PSI	2000 PSI	2500 PSI	3000 PSI	4000 PSI	7000 PSI	10,000 PSI
1/4"	TD6-46	55°	SW6	0.046	1.90	26.8	42.4	52.0	60.0	67.1	73.5	79.4	84.9	94.9	104	120	159	190
	TD5-52	65°	SW5	0.052														
	TD4-61	75°	SW4	0.061														
	TD3-70	80°	SW3	0.070														
	TD6-52	55°	SW6	0.052	2.21	31.3	49.5	60.6	70.0	78.3	85.7	92.6	99.0	111	121	140	185	221
	TD5-58	65°	SW5	0.058														
	TD4-70	75°	SW4	0.070														
	TD7-49	50°	SW7	0.049	2.53	35.8	56.6	69.3	80.0	89.4	98.0	106	113	126	139	160	212	253
	TD6-55	60°	SW6	0.055														
	TD5-64	70°	SW5	0.064														
	TD4-76	80°	SW4	0.076														
	TD7-52	50°	SW7	0.052	2.85	40.2	63.6	77.9	90.0	101	110	119	127	142	156	180	238	285
TD6-61	60°	SW6	0.061															
TD5-70	70°	SW5	0.070															
TD7-58	55°	SW7	0.058	3.16	44.7	70.7	86.6	100	112	122	132	141	158	173	200	264	316	
TD6-64	65°	SW6	0.064															
TD5-76	75°	SW5	0.076															
TD4-91	80°	SW4	0.091															
OR	TD7-61	55°	SW7	0.061	3.48	49.2	77.8	95.3	110	123	135	146	156	174	191	220	291	348
	TD6-70	65°	SW6	0.070														
	TD5-82	75°	SW5	0.082														
3/8"	TD7-64	55°	SW7	0.064	3.79	53.7	84.9	104	120	134	147	159	170	190	208	240	317	379
	TD6-76	65°	SW6	0.076														
	TD5-88	75°	SW5	0.088														
OR	TD8-67	50°	SW8	0.067	4.74	67.1	106	130	150	168	184	198	212	237	260	300	397	474
	TD7-76	60°	SW7	0.076														
	TD6-88	70°	SW6	0.088														
	TD5-109	80°	SW5	0.109														
1/2"	TD8-76	50°	SW8	0.076	5.69	80.5	127	156	180	201	221	238	255	285	312	360	476	569
	TD7-85	65°	SW7	0.085														
	TD6-103	75°	SW6	0.103														
OR	TD8-82	55°	SW8	0.082	6.64	93.9	148	182	210	235	257	278	297	332	364	420	556	664
	TD7-97	65°	SW7	0.097														
	TD6-115	75°	SW6	0.115														
3/4"	TD9-82	50°	SW9	0.082	7.59	107	170	208	240	268	294	317	339	379	416	480	635	759
	TD8-91	60°	SW8	0.091														
	TD7-106	70°	SW7	0.106														
	TD6-127	80°	SW6	0.127														
	TD9-88	50°	SW9	0.088	8.54	121	191	234	270	302	331	357	382	427	468	540	715	854
	TD8-100	60°	SW8	0.100														
	TD7-118	70°	SW7	0.118														
	TD6-142	80°	SW6	0.142														
	TD9-94	55°	SW9	0.094	9.49	134	212	260	300	335	367	397	424	474	520	600	794	949
	TD8-106	65°	SW8	0.106														
	TD7-127	75°	SW7	0.127														
	TD9-106	55°	SW9	0.106	11.1	157	247	303	350	391	429	463	495	553	606	700	929	1110
	TD8-121	65°	SW8	0.121														
	TD7-145	75°	SW7	0.145														
	TD10-103	50°	SW10**	0.103	12.7	179	283	346	400	447	490	529	566	632	693	800	1063	1270
	TD9-115	60°	SW9	0.115														
	TD8-133	70°	SW8	0.133														
	TD10-118	55°	SW10**	0.118	14.2	201	318	390	450	503	551	595	636	712	779	900	1188	1420
	TD9-127	60°	SW9	0.127														
	TD8-145	70°	SW8	0.145														
	TD9-136	65°	SW9	0.136	15.8	224	354	433	500	559	612	661	707	791	866	1000	1322	1580
	TD8-157	75°	SW8	0.157														
	TD9-148	65°	SW9	0.148	17.4	246	389	476	550	615	674	728	778	870	953	1100	1456	1740
	TD10-136	60°	SW10**	0.136	19.0	268	424	520	600	671	735	794	849	949	1040	1200	1590	1900
	TD9-154	70°	SW9	0.154														
	TD10-151	60°	SW10**	0.151	20.6	291	460	563	650	727	796	860	919	1030	1130	1300	1724	2060
	TD10-157	65°	SW10**	0.157	22.1	313	495	606	700	783	857	926	990	1110	1210	1400	1849	2210

Flow Rate (GPH) = K√PSI

Standard Materials: Carrier: Stainless Steel, Duplex; Body: Stainless Steel; Swirl/Orifice: Tungsten Carbide

Spray angle performance varies with pressure. Contact BETE for specific data on critical applications.

**SW10 only available in Pro Grade Tungsten Carbide

TDL

Twist & Dry® Low Flow Hollow Cone

DESIGN FEATURES

- Patented locking mechanism for quick and easy change-out and maintenance
- Lower flow rates than Twist & Dry series
- Female-threaded or butt weld pipe connections
- Orifice size: 0.018" through 0.058"
- Interchangeable swirl and orifice discs for variable patterns and flow rates

SPRAY CHARACTERISTICS

- Hollow Cone
- Flow rates:** 2.86 to 123 gph
- Spray angle:** 70° - 75°

Ideal for small-scale applications and pilot tests



TDL Assembly



70° Hollow Cone

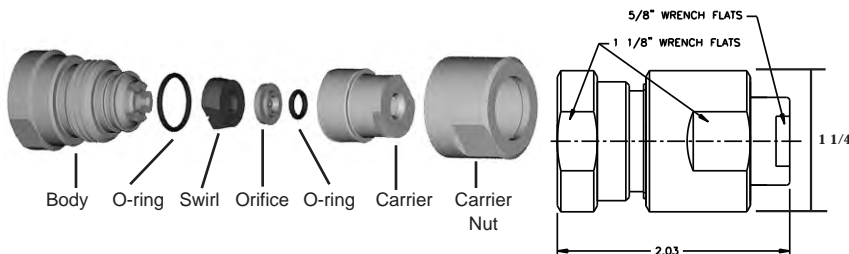

Pipe Size	Weight (oz)
1/4"	4.2
3/8"	3.8

Dimensions are approximate. Check with BETE for critical dimension applications.

TDL Flow Rates

Hollow Cone, 70° - 75° Spray Angles, 1/4" and 3/8" Pipe Sizes, NPT or BSP

Female Pipe Size	Nozzle Number	Swirl	Orifice Dia. (in.)	K Factor	GALLONS PER HOUR @ PSI											
					200 PSI	500 PSI	750 PSI	1000 PSI	1250 PSI	1500 PSI	1750 PSI	2000 PSI	2500 PSI	3000 PSI	4000 PSI	5000 PSI
1/4"	TDL4-18	SWL4	0.018	0.202	2.86	4.53	5.54	6.40	7.16	7.84	8.47	9.1	10.1	11.1	12.8	14.3
	TDL4-20	SWL4	0.020	0.215	3.04	4.81	5.89	6.80	7.60	8.33	9.00	9.62	10.8	11.8	13.6	15.2
	TDL4-22	SWL4	0.022	0.237	3.35	5.30	6.50	7.50	8.39	9.19	9.92	10.6	11.9	13.0	15.0	16.8
	TDL4-24	SWL4	0.024	0.272	3.85	6.08	7.45	8.60	9.62	10.5	11.4	12.2	13.6	14.9	17.2	19.2
	TDL4-27	SWL4	0.027	0.316	4.47	7.07	8.66	10.0	11.2	12.2	13.2	14.1	15.8	17.3	20.0	22.4
	TDL1-22	SWL1	0.022	0.348	4.92	7.78	9.53	11.0	12.3	13.5	14.6	15.6	17.4	19.1	22.0	24.6
OR	TDL1-24	SWL1	0.024	0.395	5.59	8.84	10.8	12.5	14.0	15.3	16.5	17.7	19.8	21.7	25.0	28.0
	TDL1-27	SWL1	0.027	0.459	6.48	10.3	12.6	14.5	16.2	17.8	19.2	20.5	22.9	25.1	29.0	32.4
	TDL1-30	SWL1	0.030	0.522	7.38	11.7	14.3	16.5	18.4	20.2	21.8	23.3	26.1	28.6	33.0	36.9
	TDL2-30	SWL2	0.030	0.632	8.94	14.1	17.3	20.0	22.4	24.5	26.5	28.3	31.6	34.6	40.0	44.7
	TDL2-33	SWL2	0.033	0.712	10.1	15.9	19.5	22.5	25.2	27.6	29.8	31.8	35.6	39.0	45.0	50.3
	TDL2-36	SWL2	0.036	0.791	11.2	17.7	21.7	25.0	28.0	30.6	33.1	35.4	39.5	43.3	50.0	55.9
3/8"	TDL2-38	SWL2	0.038	0.838	11.9	18.7	22.9	26.5	29.6	32.5	35.1	37.5	41.9	45.9	53.0	59.3
	TDL2-40	SWL2	0.040	0.917	13.0	20.5	25.1	29.0	32.4	35.5	38.4	41.0	45.9	50.2	58.0	64.8
	TDL2-42	SWL2	0.042	0.949	13.4	21.2	26.0	30.0	33.5	36.7	39.7	42.4	47.4	52.0	60.0	67.1
	TDL2-44	SWL2	0.044	0.980	13.9	21.9	26.8	31.0	34.7	38.0	41.0	43.8	49.0	53.7	62.0	69.3
	TDL2-46	SWL2	0.046	1.03	14.5	23.0	28.1	32.5	36.3	39.8	43.0	46.0	51.4	56.3	65.0	72.7
	TDL2-48	SWL2	0.048	1.11	15.7	24.7	30.3	35.0	39.1	42.9	46.3	49.5	55.3	60.6	70.0	78.3
	TDL2-50	SWL2	0.050	1.15	16.3	25.8	31.6	36.5	40.8	44.7	48.3	51.6	57.7	63.2	73.0	81.6
	TDL2-52	SWL2	0.052	1.25	17.7	27.9	34.2	39.5	44.2	48.4	52.3	55.9	62.5	68.4	79.0	88.3
	TDL2-54	SWL2	0.054	1.30	18.3	29.0	35.5	41.0	45.8	50.2	54.2	58.0	64.8	71.0	82.0	91.7
	TDL2-56	SWL2	0.056	1.33	18.8	29.7	36.4	42.0	47.0	51.4	55.6	59.4	66.4	72.7	84.0	93.9
3/8"	TDL3-50	SWL3	0.050	1.42	20.0	31.7	38.8	44.8	50.1	54.9	59.3	63.4	70.8	77.6	89.6	100
	TDL3-52	SWL3	0.052	1.51	21.4	33.8	41.4	47.8	53.4	58.5	63.2	67.6	75.6	82.8	95.6	107
	TDL3-54	SWL3	0.054	1.60	22.6	35.7	43.7	50.5	56.5	61.8	66.8	71.4	79.8	87.5	101	113
	TDL3-56	SWL3	0.056	1.69	23.9	37.8	46.3	53.5	59.8	65.5	70.8	75.7	84.6	92.7	107	120
TDL3-58	SWL3	0.058	1.74	24.6	38.9	47.6	55.0	61.5	67.4	72.8	77.8	87.0	95.3	110	123	

$$\text{Flow Rate (GPH)} = K\sqrt{\text{PSI}}$$

Standard Materials: Carrier: Stainless Steel; Body: Stainless Steel; Swirl/Orifice: Tungsten Carbide

Spray angle performance varies with pressure. Contact BETE for specific data on critical applications.

SPECIAL PURPOSE

TO ORDER: specify pipe size, connection type, nozzle number, and material. 413-772-0846

TurboMix®

TurboMix® Eductor Mixing Nozzle

DESIGN FEATURES

- Effective, economical way to circulate liquids in closed or open tanks
- No moving parts
- Inherently clog resistant
- Requires minimal maintenance
- Nozzle operation creates multiplying effect on fluid flow
- The volume of discharge liquid will be 3-5 times greater than the motive

liquid pumped
SPRAY CHARACTERISTICS

- Cone-shaped plume

Flow rates: 7 to 3180 gpm (motive)

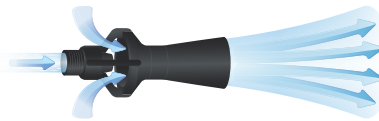

Metal

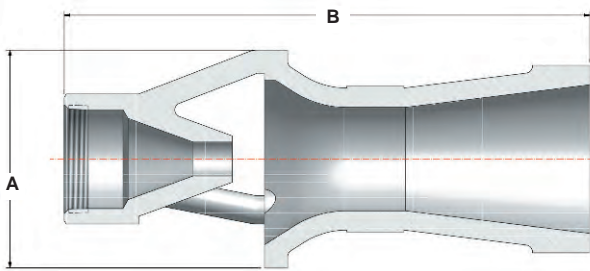

Metal

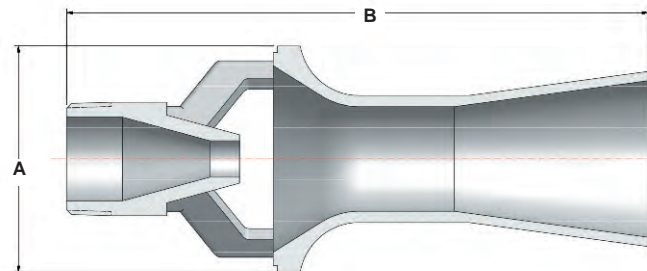

Plastic

Dimensions are approximate. Check with BETE for critical dimension applications.

TurboMix® in Molded Plastic

NPT or BSP Connection Size	TurboMix Number	K Factor	Motive Flow Rate GALLONS PER MINUTE @ PSI*							Dimensions (In.)		Wt. (lbs)	
			10 PSI	15 PSI	20 PSI	25 PSI	30 PSI	40 PSI	50 PSI	A	B		
Male	3/8	TM73	2.3	7.3	8.9	10.3	11.5	12.6	14.6	16.3	2.13	4.5	0.06
	1/2	TM120	3.8	12	14.7	17	19	20.8	24	26.8	2.5	6.5	0.08
	3/4	TM137	4.3	13.7	16.8	19.4	21.7	23.7	27.4	30.6	2.88	6.38	0.14
	1	TM240	7.6	24	29.4	33.9	37.9	41.6	48	53.7	3.5	9.5	0.32
	1 1/2	TM340	10.8	34	41.6	48.1	53.8	58.9	68.3	76.4	4.5	9.75	0.46

Standard Material: Glass-filled Polypropylene. *PSI = supply pressure at the TurboMix minus the pressure in the tank

TurboMix® in Metal

NPT or BSP Connection Size	TurboMix Number	K Factor	Motive Flow Rate GALLONS PER MINUTE @ PSI*							Dimensions (In.)		Wt. (lbs)	
			10 PSI	20 PSI	30 PSI	40 PSI	60 PSI	80 PSI	100 PSI	A	B		
Male	3/8	TM70	2.2	7	9.8	12.1	13.9	17.1	19.8	22.1	1.69	4.25	0.50
	1/2	TM110	3.5	11	15.6	19.1	22	26.9	31.1	34.8	2.16	5.25	0.75
	3/4	TM150	4.7	15	21.2	25.7	29.7	36.7	42.4	47.4	2.63	6.25	1.50
	1	TM230	7.3	23	32.5	39.8	46	56.3	65.1	72.7	3.25	7.88	2.75
Female	1 1/2	TM320	10.1	32	45.3	55.4	63.9	78.4	90.5	101	3.81	9.19	6.50
	2	TM620	19.6	62	87.7	107	124	152	175	196	4.75	11.25	12.5
	3	TM1500	47.4	150	212	260	300	367	424	474	5.75	19.38	40.0
150# Flange	4	TM2510	79.4	251	355	435	502	615	710	794	9.00	34	40.0
	6	TM6010	190	601	850	1040	1200	1470	1700	1900	12.63	52	120
	8	TM10050	318	1005	1420	1740	2010	2460	2840	3180	16.38	68	325

Motive Flow Rate (GPM) = $K \sqrt{\text{PSI}}$ *PSI = supply pressure at the TurboMix minus the pressure in the tank

Standard Materials: Brass (up to 3", inclusive), Carbon Steel, 316 Stainless Steel.

SPECIAL PURPOSE

CALL 413-772-0846
Call for the name of your nearest BETE representative.

IS

Rectangular Coverage/Mounted in Pairs

DESIGN FEATURES

- Effective wherever rectangular pattern is required
- High energy efficiency
- Large unimpeded openings
- Excellent clog resistance
- Mounted in opposing pairs
- Male connection

SPRAY CHARACTERISTICS

- Pattern widths of 18" to 120" can be achieved
- Good distribution with pressures as low as 0.5 psi
- Thick bands of droplets from opposing pairs intersect and fall uniformly

Spray pattern: Rectangular

Spray angle: See Pattern Width and Coverage Chart

Flow rates: 0.5 to 164 gpm per pair

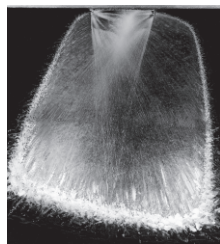
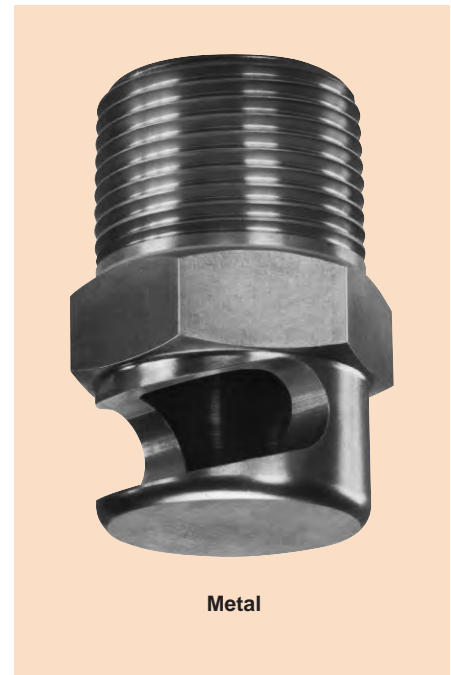

Rectangular Spray

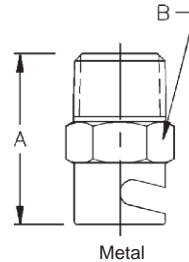
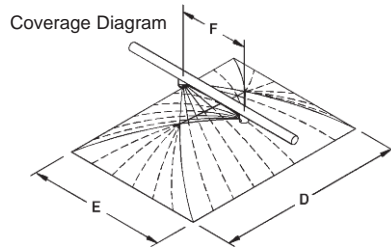

Metal

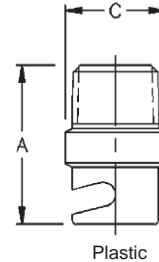

Plastic

Dimensions are approximate. Check with BETE for critical dimension applications.

IS Flow Rates and Dimensions

Rectangular Spray Pattern, 1/16" to 1 1/2" Pipe Sizes

Male Pipe Size	Nozzle Number	K Factor	GALLONS PER MINUTE PER PAIR @ PSI										Dim. (in.)			Wt. (oz.)	
			0.5 PSI	1 PSI	2 PSI	3 PSI	4 PSI	6 PSI	8 PSI	10 PSI	15 PSI	20 PSI	A	B	C	Metal	Plas.
1/16	IS2	0.71	0.50	0.71	1.0	1.2	1.4	1.7	2.0	2.2	2.7	3.2	0.75	0.31	0.38	0.13	0.06
	IS3	1.06	0.75	1.1	2.0	1.8	2.1	2.6	3.0	3.4	4.1	4.7					
1/8	IS4	1.41	1.0	1.4	2.0	2.4	2.8	3.5	4.0	4.5	5.5	6.3	0.88	0.44	0.50	1.0	0.25
	IS6	2.12	1.5	2.1	3.0	3.7	4.2	5.2	6.0	6.7	8.2	9.5					
1/4	IS8	2.83	2.0	2.8	4.0	4.9	5.7	6.9	8.0	8.9	11	13	1.06	0.56	0.62	1.5	0.38
	IS10	3.54	2.5	3.5	5.0	6.1	7.1	8.7	10	11	14	16					
3/8	IS12	4.24	3.0	4.2	6.0	7.3	8.5	10	12	13	16	19	1.25	0.69	0.75	2.0	0.5
	IS14	4.95	3.5	4.9	7.0	8.6	9.9	12	14	16	19	22					
	IS16	5.66	4.0	5.7	8.0	9.8	11	14	16	18	22	25					
1/2	IS20	7.07	5.0	7.1	10	12	14	17	20	22	27	32	1.50	0.88	0.88	3.0	1.0
	IS24	8.49	6.0	8.5	12	15	17	21	24	27	33	38					
	IS28	9.90	7.0	9.9	14	17	20	24	28	31	38	44					
3/4	IS32	11.3	8.0	11	16	20	23	28	32	36	44	51	1.75	1.13	1.13	6.0	1.5
	IS40	14.1	10	14	20	24	28	35	40	45	55	63					
	IS48	17.0	12	17	24	29	34	42	48	54	66	76					
1	IS56	19.8	14	20	28	34	40	48	56	63	77	89	2.19	1.38	1.38	8.0	2.0
	IS64	22.6	16	23	32	39	45	55	64	72	88	101					
1 1/4	IS72	25.5	18	25	36	44	51	62	72	80	99	114	2.50	1.75	1.75	12	3.0
	IS80	28.3	20	28	40	49	57	69	80	89	110	126					
1 1/2	IS88	31.1	22	31	44	54	62	76	88	98	120	139	3.00	2.00	2.00	20	5.0
	IS96	33.9	24	34	48	59	68	83	96	107	131	152					
	IS104	36.8	26	37	52	64	74	90	104	116	142	164					

Coverage

12" Mounting Height

Spacing (in.)	F	Approx. Cover. (in.) @ PSI							
		1 PSI		2 PSI		4 PSI		8 PSI	
		D	E	D	E	D	E	D	E
3		24	18	34	26	60	30	72	30
4		20	14	32	18	42	30	46	36
5		30	18	42	22	60	36	78	42
6		26	12	36	20	54	24	60	24
8		36	12	60	30	84	36	88	42
10		42	12	60	20	66	24	90	26
12		30	18	48	20	66	24	90	38
14		48	14	60	18	88	20	108	24
16		36	14	48	18	72	24	120	38

$$\text{Flow Rate (GPM)} = K \sqrt{\text{PSI}}$$

Standard Materials: Brass, 303 Stainless Steel, 316 Stainless Steel and PVC.

Spray angle performance varies with pressure. Contact BETE for specific data on critical applications.

LP

Low Profile

DESIGN FEATURES

- Provides effective cleaning with low water consumption
- Interchangeable family of shower nozzles
- Self-aligning
- Orifice designed for efficient cleaning

SPRAY CHARACTERISTICS

Spray patterns: Straight Jet and Flat Fan.

Spray Angles: 0°, 30° and 60°

Flow rates: 0.041 to 43.9 gpm

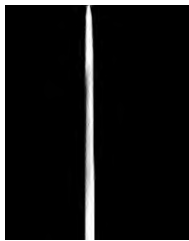

0° Fan

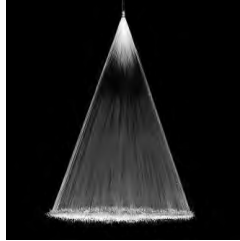

30° Fan

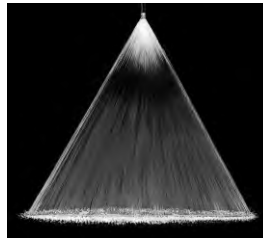

60° Fan



Retaining ring



LP nozzle



Gasket

Dimensions are approximate. Check with BETE for critical dimension applications.

LP Flow Rates and Dimensions

Fan and Straight Jet, 0°, 30° and 60° Spray Angles

Nozzle Number	Available Spray Angle			K Factor	GALLONS PER MINUTE @ PSI					Equivalent Orifice Dia. (in)
	0°	30°	60°		40 PSI	60 PSI	100 PSI	250 PSI	500 PSI	
LP0041	0°			0.0065	0.041	0.050	0.065	0.103	0.14	0.016
LP0073	0°			0.0116	0.073	0.089	0.12	0.18	0.26	0.024
LP0090	0°			0.0142	0.090	0.11	0.14	0.23	0.32	0.028
LP013	0°			0.0207	0.13	0.16	0.21	0.33	0.46	0.031
LP023	0°	30°	60°	0.0361	0.23	0.28	0.36	0.58	0.81	0.039
LP033	0°	30°	60°	0.0516	0.33	0.40	0.52	0.83	1.17	0.047
LP043	0°	30°	60°	0.0671	0.42	0.51	0.66	1.05	1.48	0.059
LP08	0°	30°	60°	0.127	0.80	0.98	1.26	2.00	2.83	0.079
LP12	0°	30°	60°	0.196	1.24	1.52	1.96	3.10	4.38	0.098
LP20	0°	30°	60°	0.312	1.98	2.42	3.13	4.95	7.00	0.118
LP31			60°	0.497	3.14	3.85	4.96	7.85	11.1	0.157
LP49			60°	0.775	4.90	6.00	7.75	12.3	17.3	0.197
LP78			60°	1.24	7.84	9.60	12.4	19.6	27.7	0.236
LP99			60°	1.56	9.88	12.1	15.6	24.7	34.9	0.276
LP124			60°	1.96	12.4	15.2	19.6	31.0	43.9	0.315

$$\text{Flow Rate (GPM)} = K\sqrt{\text{PSI}}$$

Standard Materials: 316 Stainless Steel

Spray angle performance varies with pressure. Contact BETE for specific data on critical applications.

SPECIAL PURPOSE

CALL 413-772-0846
Call for the name of your nearest BETE representative.

PSR

Small Physical Size Straight Jet

DESIGN FEATURES

- High velocity jet
- Small physical size
- Small orifice size: 0.014" through 0.125"
- Interchangeable with most other needle type showers

SPRAY CHARACTERISTICS

- Hard-driving straight jet
- Flow rates:** 0.028 to 8.21 gpm
Spray angle: 0°

TYPICAL APPLICATIONS

Cleaning, Degreasing,
 Cleaning Wires and Felts—Pulp and Paper

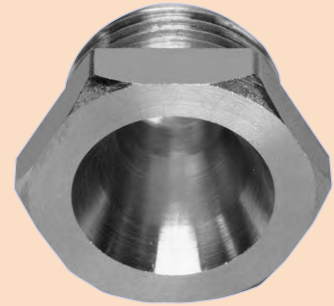

0° Straight Jet

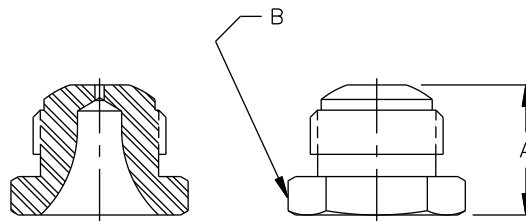

Male

Dimensions are approximate. Check with BETE for critical dimension applications.

PSR Flow Rates and Dimensions Straight Jet 9/16"-24 UNEF Thread

Nozzle Number	K Factor	GALLONS PER MINUTE @ PSI								Equivalent Orifice Dia. (in.)	Approx. Dim. (in.) Wt. (oz.)		
		30 PSI	40 PSI	50 PSI	60 PSI	100 PSI	200 PSI	400 PSI	800 PSI		A	B	
PSR03	0.00565	0.028	0.032	0.036	0.039	0.049	0.068	0.094	0.13	0.014	0.55	0.69	0.5
PSR11	0.0194	0.096	0.11	0.12	0.13	0.17	0.23	0.33	0.45	0.028			
PSR16	0.0272	0.14	0.16	0.18	0.19	0.25	0.35	0.48	0.67	0.033			
PSR23	0.0392	0.20	0.23	0.26	0.29	0.33	0.50	0.70	0.97	0.040			
PSR40	0.0681	0.35	0.40	0.45	0.49	0.62	0.87	1.21	1.68	0.055			
PSR67	0.114	0.58	0.67	0.75	0.81	1.04	1.45	2.02	2.82	0.070			
PSR120	0.204	1.05	1.20	1.34	1.46	1.86	2.60	3.62	5.05	0.094			
PSR195	0.332	1.70	1.95	2.17	2.37	3.03	4.22	5.89	8.21	0.125			

$$\text{Flow Rate (GPM)} = K (\text{PSI})^{0.48}$$

Standard Materials: 316 Stainless Steel.

Spray angle performance varies with pressure. Contact BETE for specific data on critical applications.

SPECIAL PURPOSE

TO ORDER: specify pipe size, connection type, nozzle number, and material.

FINZ™

High Impact Fan Air Nozzle

DESIGN FEATURES

- Controlled wide uniform distribution and high impact coverage of compressed air
- Can be mounted individually or side-by-side for greater coverage
- Efficient air flow with unique eductor feature
- Safe operation—meets OSHA specifications for noise and deadhead pressure
- 1/4" male connection is molded to fit either NPT or BSP
- Up to 2 dB quieter than competing designs

- Rugged construction of Ryton® or ABS plastic.
Ryton® (black) rated to 300°F at 40 psi;
ABS (orange) rated to 155°F at 100 psi.
- Maximum operating pressure 100 psi

SPRAY CHARACTERISTICS

Spray pattern: Fan

Air Flow Rates: 4 to 41 SCFM at 10 to 90 psi

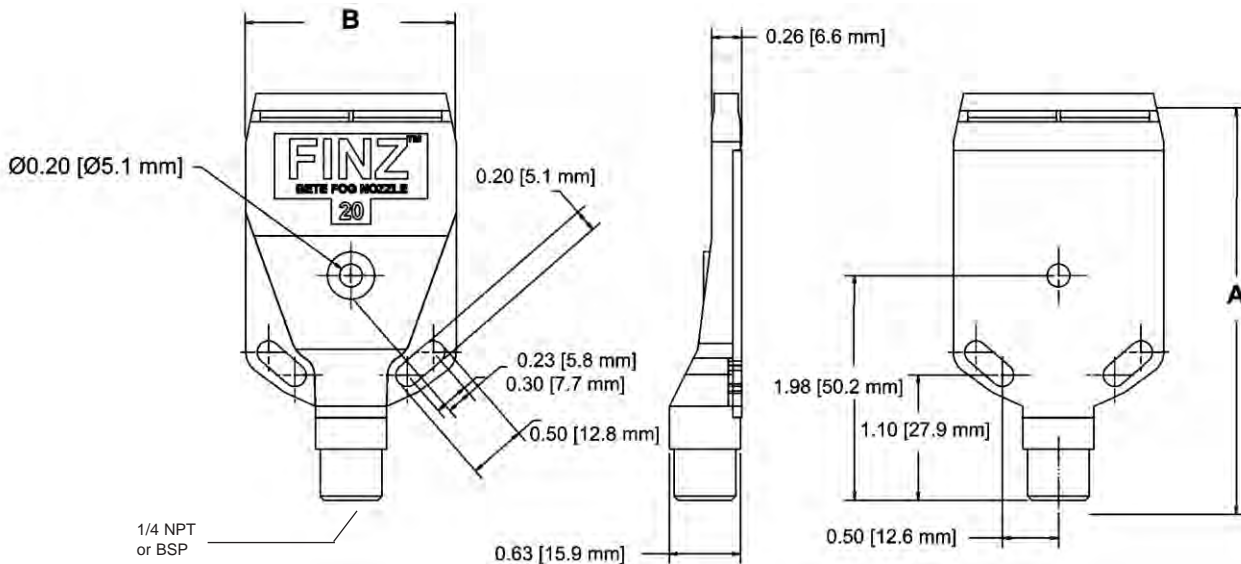

Dimensions are approximate. Check with BETE for critical dimension applications.

FINZ

High Impact Air Nozzle

Male NPT BSP	Nozzle Number	Air Capacity SCFM				Approx. Dim. in.		Wt. (oz.)
		10 PSI	30 PSI	60 PSI	90 PSI	A	B	
1/4"	FZ20	4	8	12	16	3.58	1.85	1.0
	FZ29	7	13	21	28			
	FZ41	9	18	30	41			

Standard Materials: Ryton® and ABS plastic.

Ryton is a trademark of Phillips Petroleum company

SPECIAL PURPOSE

CALL 413-772-0846
Call for the name of your nearest BETE representative.

SJ

Swivel Joints

DESIGN FEATURES

- Adjustable swivel joints allow custom alignment of spray nozzles without expensive piping changes
- Leak-proof design
- Standard materials are brass and stainless steel
- Other materials available upon request

SPRAY CHARACTERISTICS

- **Adjustment angles:** From 30° to 45°
- Greater control of spray direction for precise coverage

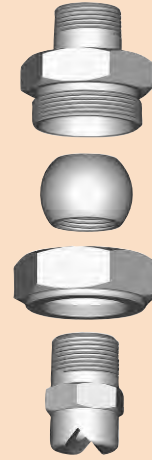

Adjustable Swivel Joints
aid in aligning spray nozzles

(Optional NF nozzle shown,
choose nozzle when ordering)

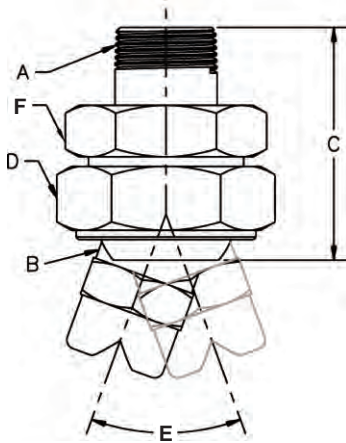

Dimensions are approximate. Check with BETE for critical dimension applications.

Swivel Joint Dimensions

Part Number	A Inlet Pipe Conn. BSP or NPT	B Outlet Pipe Conn. BSP or NPT	C Overall Length (in.)	D Hex Size (in.)	E Angle of Adjustment	F Hex Size	Net Wt.* (oz.)
1/8 x 1/8 SJ	1/8 M	1/8 F	1.25	0.813	45°	0.813	2.0
1/4 x 1/4 SJ	1/4 M	1/4 F	1.50	1.13	45°	1.00	3.9
3/8 x 1/4 SJ	3/8 M	1/4 F	1.75	1.50	45°	1.38	8.6
3/8 x 3/8 SJ	3/8 M	3/8 F	1.75	1.50	45°	1.38	8.6
1/2 x 3/8 SJ	1/2 M	3/8 F	2.00	1.75	45°	1.63	12.9
1/2 x 1/2 SJ	1/2 M	1/2 F	2.00	1.75	45°	1.63	12.2
3/4 x 1/2 SJ	3/4 M	1/2 F	2.13	2.00	45°	1.88	17.8
3/4 x 3/4 SJ	3/4 M	3/4 F	2.13	2.00	45°	1.88	16.4
1x1 SJ	1 M	1 F	3.00	2.44	45°	2.25	34.1
1 1/4 x 1 1/4 SJ	1 1/4 M	1 1/4 F	3.50	3.13	30°	2.88	67.0
1 1/2 x 1 1/2 SJ	1 1/2 M	1 1/2 F	3.88	3.38	30°	3.38	94.5
2 x 2 SJ	2 M	2 F	4.13	4.00	40°	3.50	103







* Weights are based on brass and represent one of the heavier materials

SPECIAL PURPOSE

TO ORDER: specify pipe size, connection type,
nozzle number, and material.

Accessories

Components & Sizes

	Components	Materials	Sizes												
Nozzle Strainers 	Optional strainer to fit BJ and CW nozzles. All strainers equipped with 316 stainless steel screens of various mesh sizes.	316 stainless steel	Mesh Sizes: 50 (S201) 100 (S202) 200 (S203) 400 (S204)												
Reducing Bushings 	BETE nozzles are often installed in pipe sizes larger than their connection. These bushings will adapt BETE nozzles to existing piping.	316 stainless steel nickel alloy C-276 nickel alloy 625 PVC PTFE	Bushing Sizes: 1/4 x 1/8 3/8 x 1/8, 1/4 1/2 x 1/8, 1/4, 3/8 1 x 1/4, 3/8, 1/2, 3/4 1-1/2 x 1/4, 1/2, 1 2 x 1/2, 1												
Y-Type Line Strainers 	BETE recommends the use of strainers to minimize clogging. The 1/4" and 3/8" strainers are equipped with 100-mesh screens, while 1/2" - 2" strainers come with 80-mesh screens. Screens with mesh sizes of 20, 24, 50 and 60 available on special order. Screens are easily removed for cleaning. 150 psi rating.	Bronze body with heavy-duty stainless steel wire mesh.	Strainer Sizes: 1/4, 3/8, 1/2, 3/4, 1, 1-1/2, 2 <table border="1"> <thead> <tr> <th>Mesh Sizes</th> <th>Screen Opening</th> </tr> </thead> <tbody> <tr> <td>100</td> <td>0.005"</td> </tr> <tr> <td>80</td> <td>0.007"</td> </tr> <tr> <td>50</td> <td>0.011"</td> </tr> <tr> <td>24</td> <td>0.028"</td> </tr> <tr> <td>20</td> <td>0.034"</td> </tr> </tbody> </table>	Mesh Sizes	Screen Opening	100	0.005"	80	0.007"	50	0.011"	24	0.028"	20	0.034"
Mesh Sizes	Screen Opening														
100	0.005"														
80	0.007"														
50	0.011"														
24	0.028"														
20	0.034"														
Adapters and Couplings 	Reducing couplings, socket adapters, elbows, and various other fittings are available to meet specific applications.	Wide range of materials available	Sizes available as required												
Flanges 	Alternate method for nozzle attachment. 150# standard for nozzles; other ratings available.	Wide range of materials available	Flange Sizes: 2" - 12" DN 50 - DN 300												
Manifolds 	Used to cluster many nozzles into a small physical space	Wide range of materials available	Standard Sizes <table border="1"> <thead> <tr> <th>Inlet</th> <th>Outlets</th> </tr> </thead> <tbody> <tr> <td>1/2"</td> <td>x (7) 3/8"-24 UNF</td> </tr> <tr> <td>3/4"</td> <td>x (6) 1/4" or 3/8"</td> </tr> <tr> <td>1"</td> <td>x (6) 3/8" or 1/2"</td> </tr> </tbody> </table>	Inlet	Outlets	1/2"	x (7) 3/8"-24 UNF	3/4"	x (6) 1/4" or 3/8"	1"	x (6) 3/8" or 1/2"				
Inlet	Outlets														
1/2"	x (7) 3/8"-24 UNF														
3/4"	x (6) 1/4" or 3/8"														
1"	x (6) 3/8" or 1/2"														

SPECIAL PURPOSE

CALL 413-772-0846
Call for the name of your nearest BETE representative.

SPECIFYING SPRAY NOZZLES

Spray nozzles have three basic functions:

- meter flow
- distribute liquid
- break up a liquid stream into droplets

The process of choosing a nozzle includes specifying:

- its flow-rate-versus-pressure characteristics (see catalog flow rate tables)
- how the droplets will be distributed after leaving the nozzle (see spray pattern, pp. 2, 3)
- the size of the droplets that will be produced (contact BETE Applications Engineering if droplet size is critical)
- the nozzle connection to the feed pipe (see dimension tables)
- the material of construction (see page 12 for complete list)

FLOW RATE

The volume of liquid flowing through a nozzle depends primarily on the difference in fluid pressure upstream of its orifice and the pressure into which the nozzle discharges (normally that of the atmosphere). Pressures that are listed in the flow rate tables of each nozzle series are *gauge pressures*.

Flow rates for pressures not tabulated may be calculated using the equation given at the bottom of each table. The factor "K" is listed for each nozzle and has units of $\text{gpm} \div \text{PSI}^x$.

A nozzle may discharge into a vessel where the pressure is not atmospheric. Since the nozzle flow rate is determined by the *differential* pressure across it, the

System Design Example

Calculate Total Water Flow and Pressure at Pump for Nozzles Operating at 7 PSI

Total Flow (pp. 38, 39) = (1 nozzle)(99 GPM/nozzle) = **99 GPM**

Pump Pressure Formula:

$$P_{\text{pump}} = P_{\text{nozzle}} + P_{\text{pipe losses}} + \rho h/144$$

Pipe Friction: (50')(3.09 PSI/100') = 1.6 PSI
 Fitting Loss: (3 elbows)(5'/elbow) = 15'
 (15')(3.09 PSI/100') = 0.5 PSI
 Total Piping Losses: 1.6 PSI + 0.5 PSI = **2.1 PSI**
 Elevation Losses: (62.4)(40')/144 = **17.3 PSI**

$$P_{\text{pump}} = 7 \text{ PSI} + 2.1 \text{ PSI} + 17.3 \text{ PSI} = 26.4 \text{ PSI}$$

Pump must be sized to provide 99 GPM at 26.4 PSI

flow rate may be calculated by subtracting the gauge pressure inside the vessel from the gauge pressure at the nozzle inlet as shown:

$$GPM = K (PSI_{\text{Inlet}} - PSI_{\text{Vessel}})^x$$

FLUID PROPERTIES

Specific gravity primarily affects nozzle flow. Flow rates of liquids denser than water are lower than flow rates of water at the same pressure because more energy is required to accelerate denser fluids. The following relationship exists between flow rates (Q) of fluids with different specific gravities:

$$\frac{Q_2}{Q_1} = \sqrt{\frac{SG_1}{SG_2}}$$

FLUID PROPERTIES

(at room temperature)

Fluid	Viscosity	Specific Gravity
Water	1cP	SG=1
10W-30 Oil	110 cP	SG=0.88
Honey	1500 cP	SG=1.05

Viscosity also affects nozzle performance. High viscosities inhibit atomization. In general, fluids with viscosities greater than 100 cP are difficult to atomize except with air atomizing nozzles.

SYSTEM DESIGN

The piping system that supplies the nozzles must be designed to deliver the correct pressure at the nozzle inlet.

The following formula is useful in estimating the pressure a pump will have to supply to a nozzle system:

$$P_{\text{Pump}} = P_{\text{Nozzle}} + P_{\text{Pipe Losses}} + \frac{\rho h}{144}$$

where:

ρ = density of fluid (lbm/ft³)

[water = 62.4 lbm/ft³]

h = height of nozzle above

pump (ft) - negative if the nozzle is below the pump

P = pressure (PSI)

A chart of pipe friction losses is presented on page 127. In using the chart be sure to look at the *total* system flow if there are multiple nozzles to be supplied by one pipe. Elbows, tees and other pipe fittings (p. 127) also contribute to pressure loss and can be significant, especially in short, convoluted runs.

SPRAY ANGLE

The spray angle chosen for a particular application depends on the coverage required.

The spray angle for spiral nozzles is relatively stable over a wide range of pressures, while the spray angle for whirl nozzles tends to decrease as the pressure is increased. For additional information see page 126.

NOZZLE SPRAY PATTERN

The term "Spray Pattern" describes the location and spray density of the liquid emitted from a nozzle.

HOLLOW CONE SPRAY PATTERN

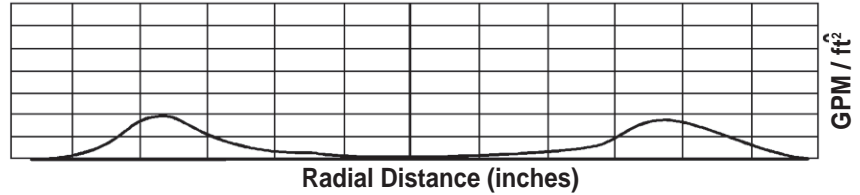

FULL CONE SPRAY PATTERN

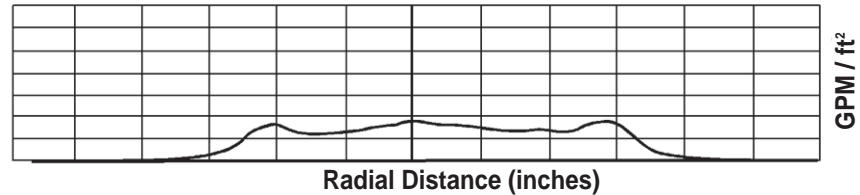

Two examples of pattern measurement are shown above. The height of the curve at any point is the spray density in units of GPM/ft².

DROPLET SIZE

Droplet size is often critical. Many processes such as gas scrubbing depend on exposing the maximum possible amount of liquid surface to a gas stream. Other applications require that the droplets be as large as possible, such as when the spray must project into a fast moving gas stream.

Exposing the maximum surface area requires breaking the liquid into droplets as small as possible. To get an idea of how this works, imagine a cube of water with a volume of 1 gallon. This cube has a surface area of 1.6 ft². If we now split it in two, we expose some of the inner surface and increase the total surface area to 2.1 ft².

Atomizing the liquid into spheres 1 mm (1,000 microns) in diameter would increase the surface area of this gallon of liquid to 244 ft².

A nozzle actually produces a range of droplet sizes from the solid liquid stream. Since it is inconvenient to list all the sizes produced, droplet size (in microns) is usually expressed by a mean or median diameter.

An understanding of diameter terms is essential.

The following definitions are given for the most frequently used mean and median diameters:

Arithmetic Mean Diameter (D₁₀):

- The average of the diameters of all the droplets in the spray sample.

Volume Mean Diameter (D₃₀):

- The diameter of a droplet whose volume, if multiplied by the total number of droplets, will equal the total volume of the sample.

Particle Size Spectrum

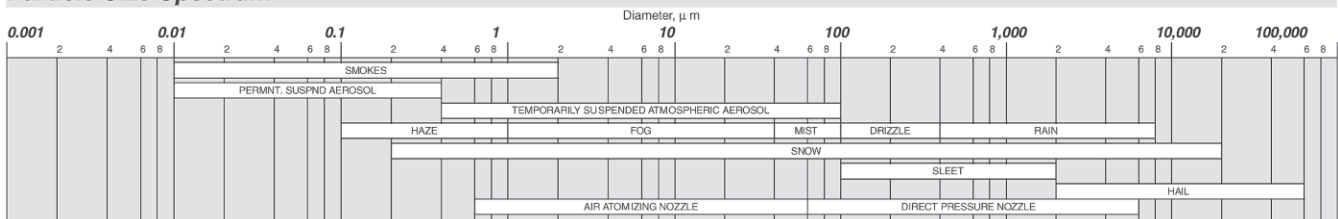

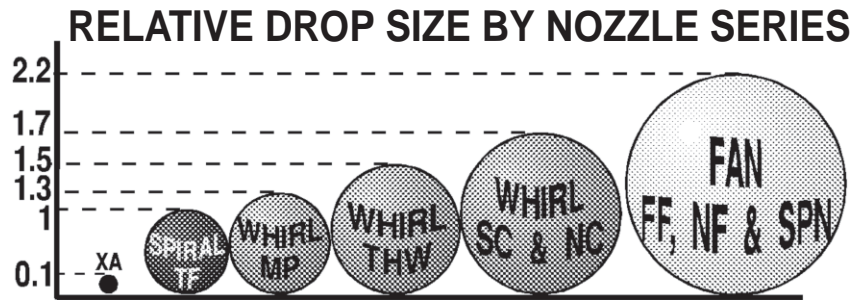

Sauter Mean Diameter (D₃₂):

- The diameter of a droplet whose ratio of volume to surface area is equal to that of the complete spray sample.

Mass (Volume) Median Diameter (DV₀₅):

- The diameter which divides the mass (or volume) of the spray into two equal halves. Thus 1/2 of the total mass is made up of droplets with diameters smaller than this number and the other half with diameters that are larger.

The Sauter Mean Diameter is one of the most useful ways to characterize a spray. The ratio of volume to surface area for the Sauter Mean is the same as that ratio for the entire spray volume. For this reason, the use of the

Sauter Mean is preferred for process calculations.

Whirl nozzles generally produce larger droplets than spiral nozzles, and air-atomizing nozzles such as the XA or SpiralAir Series typically produce the smallest droplets of all.

It is sometimes useful to predict the effect a change in pressure will have on the droplet size produced by the nozzle. For single fluid nozzles the following equation may be used for modest changes in pressure:

$$\frac{D_2}{D_1} = \left(\frac{P_2}{P_1} \right)^{-0.3}$$

TROUBLESHOOTING BASICS

The following are some of the things to look for when a system is not performing as intended:

Nozzle Wear or Corrosion

- may cause excessive flow rate due to enlarged passages
- may increase droplet size
- degrades spray pattern

Nozzle Clogging

- low flow rates
- poor spray pattern

Inadequate Pipe Size

- excessive pipe pressure losses leading to low nozzle pressures
- high velocities in headers that disrupt fluid entering the nozzle

Incorrect Nozzle Location

- poor gas/liquid contact in scrubbers and quenchers
- poor area coverage

Incorrect Nozzle for Application

- drop size too small or too large
- incorrect pattern type

Careful system design and selection of the proper BETE nozzle will minimize spray problems.

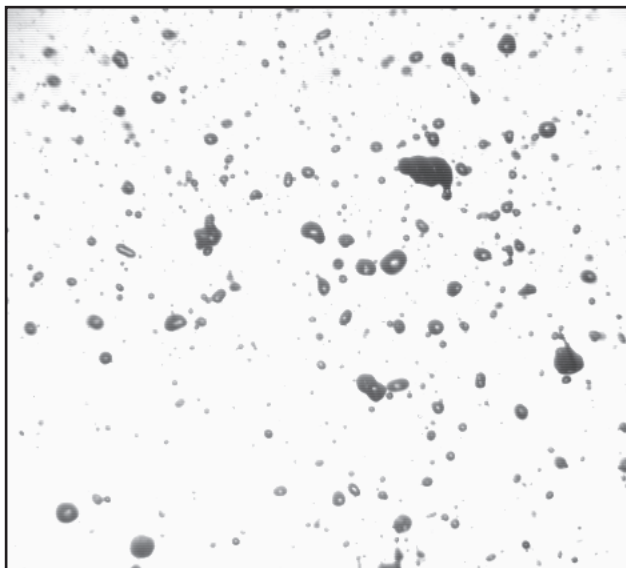

Actual droplet images captured using the BETE Model 700 Spray Analysis System.

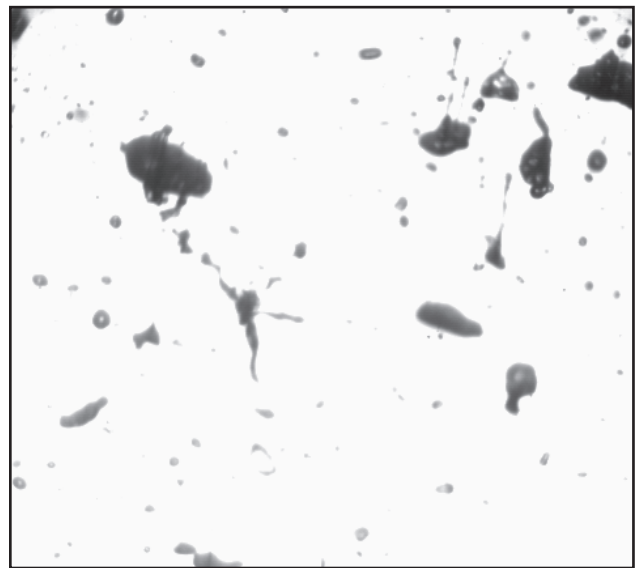

The BETE Droplet Analyzer is capable of characterizing non-spherical droplets like those seen in this actual image.

Research & Development

RESEARCH & DEVELOPMENT

BETE's state-of-the-art

Spray Laboratory (details on page 16) plays a key role in supporting both product R&D and our customer service network.

Equipped with sophisticated video-image processing, CFD, and digital analysis technology, the Spray Lab makes possible rapid nozzle development and evaluation.

The Spray Lab is also available on a contract basis to provide confidential, quantitative evaluation of nozzle performance. Industrial applications for contract testing range from comparative nozzle performance testing to development of proprietary designs. These capabilities allow our customers to optimize process performance while minimizing capital and operating costs—a winning combination in today's competitive global marketplace.

Spray Laboratory Capabilities

- Flow rate (water) measurements from 0.01 to 2000 gpm
- Flow rate (air) measurements to 3000 scfm
- Pressure measurements to 10,000 psi
- Automated drop size distribution measurement from less than 2 to greater than 15,000 microns
- Computerized spray distribution analysis
- Two-fluid capabilities up to 3000 scfm air / 2000 gpm water
- 30' x 50' x 22' high test area

DROPLET ANALYSIS

Frustrated by the limited capabilities of laser-based instruments, BETE developed the Model 700 Video Particle Analyzer. This flexible system allows BETE to characterize the difficult sprays containing significant numbers of

large and non-spherical drops often encountered in industrial applications. The Model 700 is a video-imaging system combining a CCD video camera, microscope lens, fast strobed xenon light source, and image processing hardware and software running on a host PC-compatible computer.

PATTERN DISTRIBUTION ANALYSIS

The BETE Patternator is a unique digital video system for accurately analyzing the volumetric distribution of liquid emitted from a nozzle. The system uses a standard tube patternator combined with BETE's custom shape recognition and timing software. From this digitized information, spray density and effective spray angles are calculated. Because data collection and analyses are handled by a computer, the device is very well-suited for handling the large amount of data required for nozzle development and assessment programs.

Consistently and accurately selecting appropriate sampling positions is extremely important when performing drop size analysis. The challenge lies in sampling the spray in such a way that the number and locations of the individual tests chosen present a reasonable representation of the entire spray. Recognizing this, BETE has integrated the patternator with the Model 700 analyzer on a calibrated X-Y-Z positioner and developed a number of sampling protocols for droplet size analysis. These protocols ensure that the reported drop size distributions most accurately reflect the overall spray performance, thus allowing a high degree of repeatability and confidence.

COMPUTER MODELING AND SIMULATION

There are instances when duplicating the operating environment in the spray lab is impossible. When the nozzle is to be used in a high-temperature or pressure environment or sprayed in a high velocity gas stream, BETE Applications Engineers use computer modeling and simulation software developed in-house to assist in specifying the proper nozzle.

Spray-modeling has also been used to predict spray behavior in HF mitigation systems and to specify nozzles and layouts on off-shore drilling platforms. Other applications include predicting spray drift from cooling ponds and dust suppression systems and estimating evaporation rates from disposal ponds.

Working with engineering companies and consulting groups, BETE Engineering taps this modeling and simulation technology to offer customized spray nozzle solutions to some of the most vexing problems facing today's industries.

INDUSTRY COOPERATIVE DEVELOPMENT PROGRAMS

BETE has worked closely with major industries in research and development programs addressing personnel safety and environmental protection issues.

BETE has provided technical expertise, computer simulation, testing, and nozzle prototypes in a variety of projects, including:

- fire control aboard offshore drilling platforms
- toxic gas control
- oil spill cleanup
- reducing CFC use in the semi-conductor industry

Spray Coverage

SPRAY ANGLE TERMS

Four terms are commonly used to describe spray coverage:

Spray Angle:

(A) The included angle of the spray as measured close to the nozzle orifice. Since the droplets are immediately acted upon by external forces (gravity and moving gases, for example), this measurement is useful only for determining spray coverage close to the nozzle. The spray angles listed for nozzles in this catalog are angles at the nozzle, measured at the nozzle's design pressure, which is highlighted in each chart of flow rate vs. pressure.

Actual Spray Coverage:

(B) The actual coverage at a specified distance **(D)** from the nozzle.

Effective Spray Angle:

(C) The angle calculated from the actual coverage **(B)** at a distance **(D)**.

Theoretical Spray Coverage:

(E) The coverage at distance **(D)** if the spray moved in a straight line.

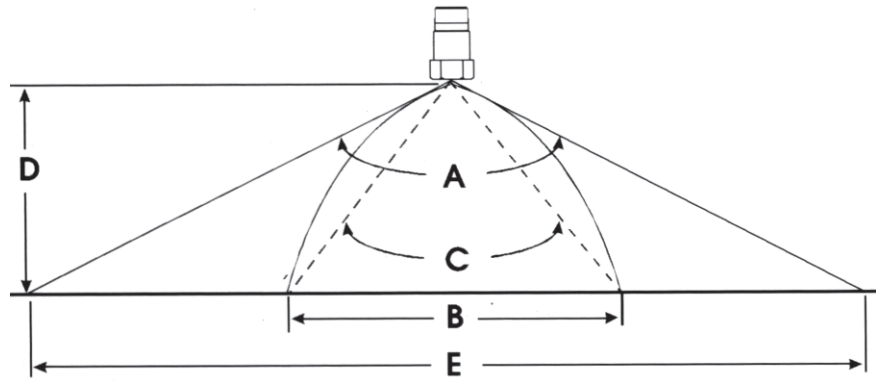

THEORETICAL SPRAY COVERAGE (E) IN INCHES

Included Spray Angle (A)	Distance From Nozzle Orifice (D) (inches)										
	2	4	6	8	10	12	15	18	24	30	36
10°	0.4	0.7	1.1	1.4	1.8	2.1	2.6	3.1	4.2	5.2	6.3
20°	0.7	1.4	2.1	2.8	3.5	4.2	5.3	6.4	8.5	10.6	12.7
30°	1.1	2.1	3.2	4.3	5.4	6.4	8.1	9.7	12.8	16.1	19.3
40°	1.5	2.9	4.4	5.8	7.3	8.7	10.9	13.1	17.5	21.8	26.2
50°	1.9	3.7	5.6	7.5	9.3	11.2	14.0	16.8	22.4	28.0	33.6
60°	2.3	4.6	6.9	9.2	11.5	13.8	17.3	20.6	27.7		
70°	2.8	5.6	8.4	11.2	14.0	16.8	21.0	25.2	33.6		
80°	3.4	6.7	10.1	13.4	16.8	20.2	25.2	30.3	40.3		
90°	4.0	8.0	12.0	16.0	20.0	24.0	30.0	36.0	48.0		
100°	4.8	9.5	14.3	19.1	23.8	28.6	35.8	43.0			
110°	5.7	11.4	17.1	22.8	28.5	34.3	42.8	51.4			
120°	6.9	13.9	20.8	27.7	34.6	41.6	52.0	62.4			
130°	8.6	17.2	25.7	34.3	42.9	51.5	64.4				
140°	10.9	21.9	32.9	43.8	54.8	65.7					
150°	14.9	29.8	44.7	59.6	74.5						
170°	45.8	91.6									

NOTE: Data shown is theoretical and does not take into consideration the effects of gravity, gas flow, or high pressure operation.

EXAMPLES:

Problem: To achieve a 10" diameter spray coverage from a nozzle mounted 15" from the target, what spray angle would be required?

Solution: 40° Spray Angle

Problem: How far from the target should a nozzle with a 110° spray angle be mounted in order to achieve a 36" diameter spray?

Solution: Approximately 15". (Actual coverage will be less than theoretical coverage listed in the table.)

NOTE: For applications where coverage is critical, contact BETE Applications Engineering using the Application Intake Form on page 130.

Water Flow Data

FLOW OF WATER THROUGH SCHEDULE 40 STEEL PIPE

Pressure Drop per 100 feet and Velocity in Schedule 40 Pipe for Water at 60° F

Discharge		Velocity		Press. Drop		Velocity		Press. Drop		Velocity		Press. Drop		Velocity		Press. Drop	
		feet per Second	Lbs. per Sq. In.	feet per Second	Lbs. per Sq. In.	feet per Second	Lbs. per Sq. In.	feet per Second	Lbs. per Sq. In.	feet per Second	Lbs. per Sq. In.	feet per Second	Lbs. per Sq. In.	feet per Second	Lbs. per Sq. In.	feet per Second	Lbs. per Sq. In.
0.2	0.000446	1/8"		1/4"		3/8"		1/2"		3/4"		1"		1 1/4"		1 1/2"	
0.3	0.000668	1.13	1.86	0.616	0.359												
0.4	0.000891	1.69	4.22	0.924	0.903	0.504	0.159	0.317	0.061								
0.5	0.00111	2.26	6.98	1.23	1.61	0.672	0.345	0.422	0.086								
0.6	0.00178	2.82	10.5	1.54	2.39	0.840	0.539	0.528	0.167	0.301	0.033						
0.8	0.00178	3.39	14.7	1.85	3.29	1.01	0.751	0.633	0.240	0.361	0.041						
1	0.00223	4.52	25.0	2.46	5.44	1.34	1.25	0.844	0.408	0.481	0.102						
2	0.00446	5.65	37.2	3.08	8.28	1.68	1.85	1.06	0.600	0.602	0.155	0.371	0.048				
3	0.00668	11.29	134.4	6.16	30.1	3.36	6.58	2.11	2.10	1.20	0.526	0.743	0.164	0.429	0.044	0.473	
4	0.00891			9.25	64.1	5.04	13.9	3.17	4.33	1.81	1.09	1.114	0.336	0.644	0.09	0.630	
5	0.01114			12.33	111.2	6.72	23.9	4.22	7.42	2.41	1.83	1.49	0.565	0.858	0.150	0.771	
6	0.01337	2"		2 1/2"		3"		3 1/2"		4"		5"		6"			
8	0.01782	0.574	0.044														
10	0.02228	0.765	0.073	0.670	0.046												
15	0.03342	1.43	0.224	1.01	0.094												
20	0.04456	1.91	0.375	1.34	0.158	0.868	0.056										
25	0.05570	2.39	0.561	1.68	0.234	0.090	0.083	0.812	0.041								
30	0.06684	2.87	0.786	2.01	0.327	1.30	0.114	0.974	0.056								
35	0.07798	3.35	1.05	2.35	0.436	1.52	0.151	1.14	0.074	0.882	0.041						
40	0.08912	3.83	1.35	2.68	0.556	1.74	0.192	1.30	0.095	1.01	0.052						
45	0.1003	4.30	1.67	3.02	0.668	1.95	0.239	1.46	0.117	1.13	0.064						
50	0.1114	4.78	2.03	3.35	0.839	2.17	0.288	1.62	0.142	1.26	0.076						
60	0.1337	5.74	2.87	4.02	1.18	2.60	0.406	1.95	0.204	1.51	0.107						
70	0.1560	6.70	3.84	4.69	1.59	3.04	0.540	2.27	0.261	1.76	0.143	1.12	0.047				
80	0.1782	7.65	4.97	5.36	2.03	3.47	0.687	2.60	0.334	2.02	0.180	1.28	0.060				
90	0.2005	8.60	6.20	6.03	2.53	3.91	0.861	2.92	0.416	2.27	0.224	1.44	0.074				
100	0.2228	9.56	7.59	6.70	3.09	4.34	1.05	3.25	0.509	2.52	0.272	1.60	0.090	1.11	0.036	15.78	
125	0.2785	11.97	11.76	8.38	4.71	5.43	1.61	4.06	0.769	3.15	0.415	2.01	0.135	1.39	0.055	19.72	
150	0.3342	14.36	16.70	10.05	6.69	6.51	2.24	4.87	1.08	3.78	0.580	2.41	0.190	1.67	0.077		
175	0.3899	16.75	22.3	11.73	8.97	7.60	3.00	5.68	1.44	4.41	0.774	2.81	0.253	1.94	0.102		
200	0.4456	19.14	28.8	13.42	11.68	8.68	3.87	6.49	1.85	5.04	0.985	3.21	0.323	2.22	0.130		
225	0.5013	-	-	15.09	14.63	9.77	4.83	7.30	2.32	5.67	1.23	3.61	0.401	2.50	0.162	1.44	
250	0.5570	-	-	-	-	10.85	5.93	8.12	2.84	6.30	1.46	4.01	0.495	2.78	0.195	1.60	
275	0.6127	-	-	-	-	11.94	7.14	8.93	3.40	6.93	1.79	4.41	0.583	3.05	0.234	1.76	
300	0.6684	-	-	-	-	13.00	8.36	9.74	4.02	7.56	2.11	4.81	0.683	3.33	0.275	1.92	
350	0.7798	-	-	-	-	-	-	11.36	5.41	8.82	2.84	5.62	0.919	3.89	0.367	2.24	
400	0.8912	-	-	-	-	-	-	12.98	7.03	10.08	3.68	6.42	1.19	4.44	0.471	2.56	
450	1.0030	-	-	-	-	-	-	14.61	8.80	11.34	4.60	7.22	1.48	5.00	0.590	2.89	
500	1.114	2.03	0.059	12"		14"		16"		18"		8.02	1.81	5.55	0.720	3.21	
600	1.337	2.44	0.083	2.01	0.047							9.63	2.55	6.66	1.02	3.85	
700	1.560	2.85	0.112	2.29	0.061							11.23	3.43	7.78	1.35	4.49	
800	1.782	3.25	0.143	2.58	0.075							12.83	4.43	8.88	1.75	5.13	
900	2.005	3.66	0.179	2.87	0.091	2.13	0.047					14.44	5.58	9.99	2.18	5.77	
1000	2.228	4.07	0.218	3.14	0.118	2.37	0.057					16.04	6.84	11.10	2.68	6.41	
1200	2.674	4.88	0.306	3.44	0.128	2.85	0.080	2.18	0.042			-	-	13.33	3.81	7.70	
1400	3.119	5.70	0.409	4.01	0.171	3.32	0.107	2.54	0.055			-	-	15.55	5.13	8.98	
1600	3.565	6.51	0.527	4.59	0.219	3.79	0.138	2.90	0.071			-	-	17.77	6.61	10.26	
1800	4.010	7.32	0.663	5.16	0.276	4.27	0.172	3.27	0.088	2.58	0.050	19.99	8.37	11.54	2.08		
2000	4.456	8.14	0.808	5.73	0.339	4.74	0.209	3.63	0.107	2.87	0.060	22.21	10.3	12.82	2.55		



Valve & Fitting Losses Expressed in Equivalent Feet of Pipe

Pipe Fitting or Valve	Nominal Pipe or Tube Size (inches)													
	3/8	1/2	3/4	1	1 1/4	1 1/2	2	2 1/2	3	3 1/2	4	5	6	8
1 90° Standard Elbow	1.4	1.6	2.0	2.6	3.3	4.0	5.0	6.0	7.5	9.0	10	13	16	20
2 45° Standard Elbow	0.7	0.8	0.9	1.3	1.7	2.1	2.6	3.2	4.0	4.7	5.2	6.5	7.9	10
3 Flow-Through Branch Tee	2.7	3.0	4.0	5.0	7.0	8.0	10	12	15	18	21	25	30	40
4 Straight Through Flow Tee - No Reduction	0.9	1.0	1.4	1.7	2.3	2.6	3.3	4.1	5.0	5.9	6.7	8.2	10	13
5 Straight Through Flow Tee - Reduced 1/4	1.2	1.4	1.9	2.3	3.1	3.7	4.7	5.6	7.0	8.0	9.0	12	14	18
6 Straight Through Flow Tee - Reduced 1/8	1.4	1.6	2.0	2.6	3.3	4.0	5.0	6.0	7.5	9.0	10	13	16	20
7 Globe Valve - Fully opened	17	18	22	29	38	43	55	69	84	100	120	140	170	220
8 Gate Valve - Fully opened	0.6	0.7	0.9	1.0	1.5	1.8	2.3	2.8	3.2	4.0	4.5	6.0	7.0	9.0

Notes

FLOW OF AIR THROUGH SCHEDULE 40 STEEL PIPE

Free Air ft ³ /min. at 60°F & 14.7 psia	Compressed Air ft ³ /min. at 60°F at 100 psig	Pressure Drop per 100' of Schedule 40 Pipe For Air For 60°F and 100 Pounds Per Square Inch (PSI)									
		1/8"	1/4"	3/8"	1/2"	3/4"	1"	1 1/4"	1 1/2"	2"	
1	0.128	0.361	0.083	0.018							
2	0.256	1.31	0.285	0.064	0.020	3/4"					
3	0.384	3.06	0.605	0.133	0.042						
4	0.513	4.83	1.04	0.226	0.071						
5	0.641	7.45	1.58	0.343	0.106	0.027					
6	0.769	10.6	2.23	0.408	0.148	0.037	1"	1 1/4"			
8	1.025	18.6	3.89	0.848	0.255	0.062			0.019		
10	1.282	28.7	5.96	1.26	0.356	0.094	0.029		1 1/2"		
15	1.922		13.0	2.73	0.834	0.201	0.062				
20	2.563		22.8	4.76	1.43	0.345	0.102	0.026			
25	3.204		35.6	7.34	2.21	0.526	0.156	0.039	0.019		
30	3.845			10.5	3.15	0.748	0.219	0.055	0.026		
35	4.486			14.2	4.24	1.00	0.293	0.073	0.035		
40	5.126			18.4	5.49	1.30	0.379	0.095	0.044		
45	5.767			23.1	6.90	1.62	0.474	0.116	0.055	2"	
50	6.408			28.5	8.49	1.99	0.578	0.149	0.067		0.019
60	7.690	2 1/2"		40.7	12.2	2.85	0.819	0.200	0.094	0.027	
70	8.971				16.5	3.83	1.10	0.270	0.126	0.036	
80	10.25	0.019		21.4	4.96	1.43	0.350	0.162	0.046		
90	11.53	0.023		27.0	6.25	1.80	0.437	0.203	0.058		

Pipe Dimensions & Weights

Nominal Pipe Size	OD	Schedule	Wall Thickness	ID	Weight	Nominal Pipe Size	OD	Schedule	Wall Thickness	ID	Weight		
NPS [DN]	in [mm]		in	in	lb/ft	NPS [DN]	in [mm]		in	in	lb/ft		
1/8 [6]	0.405 [10.3]	10 10S	0.049	0.307	0.19	4 [100]	4.500 [114.3]	5 5S	0.083	4.334	3.92		
		STD 40 40S	0.068	0.269	0.25			10 10S	0.120	4.260	5.61		
		XS 80 80S	0.095	0.215	0.32			STD 40 40S	0.237	4.026	10.79		
1/4 [8]	0.540 [13.7]	10 10S	0.065	0.410	0.33			XS 80 80S	0.337	3.826	14.98		
		STD 40 40S	0.088	0.364	0.43			120	0.438	3.624	19.00		
		XS 80 80S	0.119	0.302	0.54			160	0.531	3.438	22.51		
3/8 [10]	0.675 [17.1]	10 10S	0.065	0.545	0.42			XX	0.674	3.152	27.54		
		STD 40 40S	0.091	0.493	0.57			6 [150]	6.625 [168.3]	5 5S	0.109	6.407	7.59
		XS 80 80S	0.126	0.423	0.74					10 10S	0.134	6.357	9.29
1/2 [15]	0.840 [21.3]	5 5S	0.065	0.710	0.54					STD 40 40S	0.280	6.065	18.97
		10 10S	0.083	0.674	0.67					XS 80 80S	0.432	5.761	28.57
		STD 40 40S	0.109	0.622	0.85					120	0.562	5.501	36.39
XS 80 80S	0.147	0.546	1.09	160	0.719	5.187	45.35						
XX	0.294	0.252	1.71	XX	0.864	4.897	53.16						
3/4 [20]	1.050 [26.7]	5 5S	0.065	0.920	0.68	8 [200]	8.625 [219.1]			5S	0.109	8.407	9.91
		10 10S	0.083	0.884	0.86					10 10S	0.148	8.329	13.40
		STD 40 40S	0.113	0.824	1.13					20	0.250	8.125	22.36
		XS 80 80S	0.154	0.742	1.47					30	0.277	8.071	24.70
160	0.219	0.612	1.94	STD 40 40S	0.322					7.981	28.55		
XX	0.308	0.434	2.44	60	0.406			7.813	35.64				
1 [25]	1.315 [33.4]	5 5S	0.065	1.185	0.87			XS 80 80S	0.500	7.625	43.39		
		10 10S	0.109	1.097	1.40			100	0.594	7.437	50.95		
		STD 40 40S	0.133	1.049	1.68			120	0.719	7.187	60.71		
		XS 80 80S	0.179	0.957	2.17			140	0.812	7.001	67.76		
160	0.250	0.815	2.84	XX	0.875			6.875	72.43				
XX	0.358	0.599	3.66	160	0.906			6.813	74.69				
1-1/4 [32]	1.660 [42.2]	5 5S	0.065	1.530	1.11	10 [250]	10.750 [273.1]	5S	0.134	10.482	15.19		
		10 10S	0.109	1.442	1.81			10S	0.165	10.420	18.65		
		STD 40 40S	0.140	1.380	2.27			20	0.250	10.250	28.04		
		XS 80 80S	0.191	1.278	3.00			30	0.307	10.136	34.24		
160	0.250	1.160	3.77	STD 40 40S	0.365			10.020	40.48				
XX	0.382	0.896	5.21	XS 60 80S	0.500			9.750	54.74				
1-1/2 [40]	1.900 [48.3]	5 5S	0.065	1.770	1.27			80	0.594	9.562	64.43		
		10 10S	0.109	1.682	2.09			100	0.719	9.312	77.03		
		STD 40 40S	0.145	1.610	2.72			120	0.844	9.062	89.29		
		XS 80 80S	0.200	1.500	3.63			140	1.000	8.750	104.13		
160	0.281	1.338	4.86	160	1.125			8.500	115.65				
XX	0.400	1.100	6.41	12 [300]	12.750 [323.9]			5S	0.156	12.438	20.98		
2 [50]	2.375 [60.3]	5 5S	0.065			2.245	1.60	10S	0.180	12.390	24.17		
		10 10S	0.109			2.157	2.64	20	0.250	12.250	33.38		
		STD 40 40S	0.154			2.067	3.65	30	0.330	12.090	43.77		
		XS 80 80S	0.218			1.939	5.02	STD 40 40S	0.375	12.000	49.56		
160	0.344	1.687	7.46			40	0.406	11.938	53.53				
XX	0.436	1.503	9.03			XS 80 80S	0.500	11.750	65.42				
3 [80]	3.500 [88.9]	5 5S	0.083			3.334	3.03	60	0.562	11.626	73.16		
		10 10S	0.120			3.260	4.33	80	0.688	11.374	88.63		
		STD 40 40S	0.216			3.068	7.58	100	0.844	11.062	107.32		
		XS 80 80S	0.300			2.900	10.25	120	1.000	10.750	125.49		
160	0.438	2.624	14.32			140	1.125	10.500	139.68				
XX	0.600	2.300	18.58	160	1.312	10.126	160.27						
3-1/2 [90]	4.000 [101.6]	5 5S	0.083	3.834	3.47								
		10 10S	0.120	3.760	4.97								
		STD 40 40S	0.226	3.548	9.11								
		XS 80 80S	0.318	3.364	12.51								
XX	0.636	2.728	22.85										

BETE Fog Nozzle, Inc. Application Intake Sheet

www.bete.com/contact/support
 EMAIL: appseng@bete.com
 FAX: 413 772-6729

Name: _____ Company: _____

Telephone: _____ Company Address: _____

FAX: _____ email: _____ BETE Cust. # _____

Sketch a simple representation of the application below:

<ul style="list-style-type: none"> • What are you trying to accomplish with the spray? 	
<ul style="list-style-type: none"> • What is the available pressure? 	<ul style="list-style-type: none"> • What is the desired material of construction?
<ul style="list-style-type: none"> • What is the flow rate? 	<ul style="list-style-type: none"> • What is the piping material?
<ul style="list-style-type: none"> • What is the desired flow rate? 	<ul style="list-style-type: none"> • What are the size and connection types desired?
<ul style="list-style-type: none"> • What liquid is being sprayed? 	<ul style="list-style-type: none"> • What is the distance from the nozzle to the target?
<ul style="list-style-type: none"> • What is the desired spray angle or coverage? 	<ul style="list-style-type: none"> • What are the environmental conditions surrounding the nozzle?

Conversions & Equations

Q = Flow rate

PSI = Pressure SG= Specific Gravity

$$Q = K (PSI)^x$$

$$\left(\frac{Q_2}{Q_1}\right) = \sqrt{\frac{SG_1}{SG_2}}$$

$$P = \left(\frac{Q}{K}\right)^{1/x}$$

Vessel with internal pressure:

$$\left(\frac{Q_2}{Q_1}\right) = \left(\frac{P_2}{P_1}\right)^x$$

$$GPM = K (P_{inlet} - P_{Vessel})^x$$

Dropsizes

System Design

$$\left(\frac{D_2}{D_1}\right) = \left(\frac{P_2}{P_1}\right)^{0.3}$$

$$P_{Pump} = P_{Nozzle} + P_{Pipe Losses} + \frac{\rho h}{144}$$

Nozzle Series	Exponent x	Nozzle Series	Exponent x
BJ	0.50	PJ	0.50
CW	0.47	PSR	0.50
FF	0.50	SC	0.47
IS	0.50	SPN	0.50
L	0.50	ST	0.50
LP	0.50	STXP	0.50
MaxiPass	0.47	TC	0.46
MPL	0.43	TD/TDL	0.50
MicroWhirl	0.50	TF	0.50
N	0.50	TFXP	0.50
NC	0.47	TH, THW	0.50
NCJ	0.47	TW	0.50
NCK	0.47	WL	0.47
NCS	0.47	WT	0.50
NF	0.50	WTX	0.50
P	0.50	WTZ	0.50

Conversion Data		
MULTIPLY	BY	TO OBTAIN
atmospheres	1.013	bar
atmospheres	33.931	feet of water
atmospheres	1.0332	kg/cm ²
atmospheres	101.3	kiloPascals (kPa)
atmospheres	14.696	psi
bar	100	kPa
bar	14.5	psi
barrels (oil)	42	gallons
centimeters	0.3937	inches
centiStokes	Sp. gravity	centiPoise
cm ³	0.061	in ³
cm ³	0.000264	gallons
cm ³	0.001	liters
ft ³	1728	inches
ft ³	0.02832	m ³
ft ³	7.48	gallons
ft ³	28.32	liters
ft ³ (water)	62.43	pounds (water)
in ³	16.39	cm ³
in ³	0.00433	gallons
in ³	0.164	liters
m ³	35.31	ft ³
m ³	61.024	in ³
m ³	264.2	gallons
m ³	1000	liters
degree (angle)	60	minutes
degree (Celsius)	(°C x 1.8) +32	degree (Fahrenheit)
degree (Fahrenheit)	(°F-32) x 5/9	degree (Celsius)
feet	0.3048	meters
feet/sec	30.48	centimeters/sec

Conversion Data		
MULTIPLY	BY	TO OBTAIN
feet/sec	18.29	meters/min
feet of water	0.0295	atmospheres
feet of water	0.884	inches of mercury
feet of water	0.433	psi
gallons	3785	cm ³
gallons	0.1337	ft ³
gallons	0.83267	imperial gallons
gallons	3.785	liters
gallons/min	0.06309	liters/sec
imperial gallons	1.2	gallons
horsepower	1.014	horsepower (metric)
horsepower	33,000	foot pounds/min
horsepower	746	Watts
inches	2.54	centimeters
kg/cm ²	14.22	psi
kiloWatts	1.340	horsepower
liters	1000	cm ³
liters	0.264	gallons
liters	0.22	imperial gallons
liters	33.8	ounces (fluid)
meters	3.281	feet
microns (µm)	0.0394	thousandth of an inch
miles/hr	44.7	centimeters/sec
miles/hr	1.467	feet/sec
millimeters	0.0394	inches
psi	0.068	atmospheres
psi	0.06895	bar
psi	2.307	feet of water
psi	0.0703	kg/cm ²
psi	6.895	kPa

Terms and Conditions.

Prices quoted are FOB, Greenfield, MA. Terms are Net 30 days for approved accounts. Minimum order is \$50.00 net. A restocking charge of 30% will apply for standard product accepted for return up to one year from the date of purchase. BETE FOG NOZZLE reserves the right to charge interest on past-due accounts. No goods may be returned without prior authorization. Non-Standard items are not subject to return.

BETE FOG NOZZLE reserves the right to make changes in specifications or design at any time without notice. Illustrations shown in this catalog are for information only.

Warranty—all goods are warranted for good workmanship in accordance with industry standard and will perform in accordance with the products' specification.

Limitation of Liability—BETE's liability shall be limited to the value of the product billed arising from a purchase order.

ABSORPTION • ADDITIVES • AERATION • AIR AND STEAM • AIR CONDITIONING • AIR NOZZLES
 BIODIESEL • BLOWOFF NOZZLES • CLEAN-IN-PLACE NOZZLES • CLOG-RESISTANT NOZZLES
 COATING • CONCRETE CURING • COOLING • DISTRIBUTION • DRYING • DUST CONTROL
 ETCHING • EVAPORATIVE COOLING • EVAPORATIVE DISPOSAL • FIRE PROTECTION • FLUE GAS
 DESULPHURIZATION • FOAM CONTROL • FOG NOZZLES • FOOD PROCESSING • GAS SCRUBBING
 HUMIDIFICATION • LUBRICATION • MIST ELIMINATOR WASH • MISTING • MIXING
 EDUCTORS • MOISTENING • ODOR CONTROL • PACKING • PARTS WASHING
 PETROLEUM PROCESSING • POLLUTION CONTROL • PULP BLEACHING • QUENCH
 ROLL COOLING • SCRUBBING • SPRAY DRYING • TANK WASHING • WASTEWATER TREATMENT

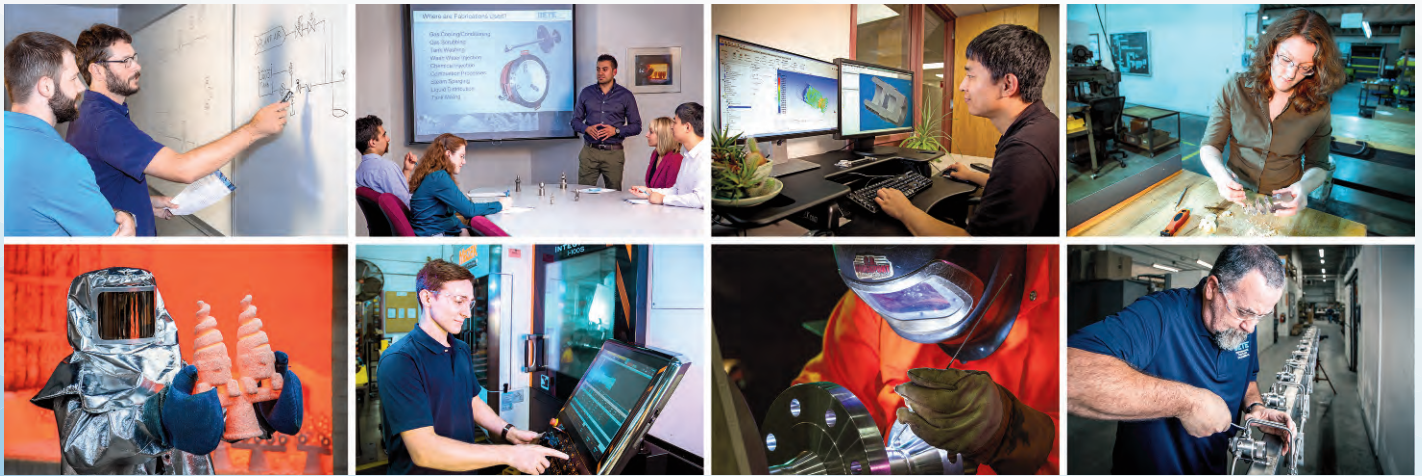

BETE®

BETE Fog Nozzle, Inc.

50 Greenfield Street
 Greenfield, MA 01301
 T (413) 772-0846 F (413) 772-6729
 Email: sales@bete.com

