



Alfa Laval TJ 20G Rotary Jet Head

Award-Winning Design

Application

The Toftejorg TJ 20G rotary jet head provides 3D indexed impact cleaning over a defined time period. It is automatic and represents a guaranteed means of achieving quality assurance in tank cleaning. Used in breweries, food and dairy processes and many other industries, the device is suitable for processing, storage and transportation tanks and vessels between 15 and 150 m³. The award-winning design is particularly suitable for hygienic industries that follow European Hygienic Equipment Design Group guidelines.

Working principle

The flow of the cleaning fluid makes the nozzles perform a geared rotation around the vertical and horizontal axes. In the first cycle, the nozzles lay out a coarse pattern on the tank surface. The subsequent cycles gradually make the pattern more dense, until a full pattern is reached after 8 cycles.



TECHNICAL DATA

Lubricant: Self-lubricating with the cleaning fluid
Standard Surface finish: Exterior surface finish Ra 0.5µm
Max throw length: 9 - 14 m
Impact throw length: 4 - 8 m
Standard thread: 1" Rp (BSP) or NPT, female Top cone.
1" Rp (BSP) with hygienic seal

Pressure

Working pressure: 3-8 bar
Recommended pressure: 5-6.5 bar

Cleaning Pattern

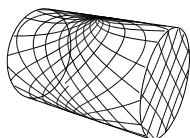

First cycle

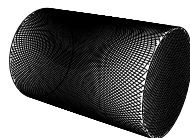

Full pattern

The above drawings show the cleaning pattern achieved on a cylindrical horizontal vessel. The difference between the first cycle and the full pattern represents the number of additional cycles available to increase the density of the cleaning.

PHYSICAL DATA

Materials
316L (UNS S31603), Duplex steel (UNS N31803), EPDM, PEEK, PVDF, PFA

Temperature
Max. working temperature: 95°C
Max. ambient temperature: 140°C

Weight: 5.1 kg

Options
Electronic rotation sensor to verify 3D coverage.

Caution
Avoid hard and abrasive particles in the cleaning liquid, as this can cause increased wear and/or damage of internal mechanisms. In general, a filter in the supply line is recommended. Do not use for gas evacuation or air dispersion.

Certificates
2.2, 3.1 material certificate and ATEX.



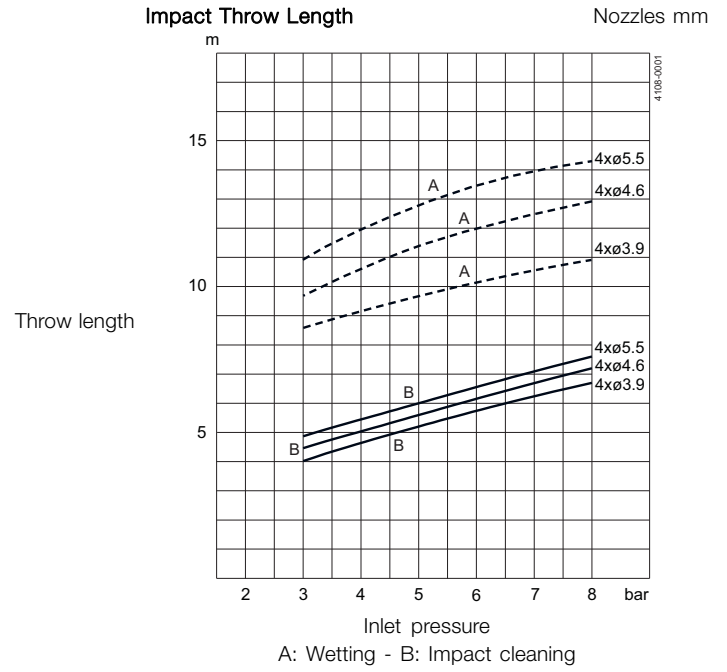
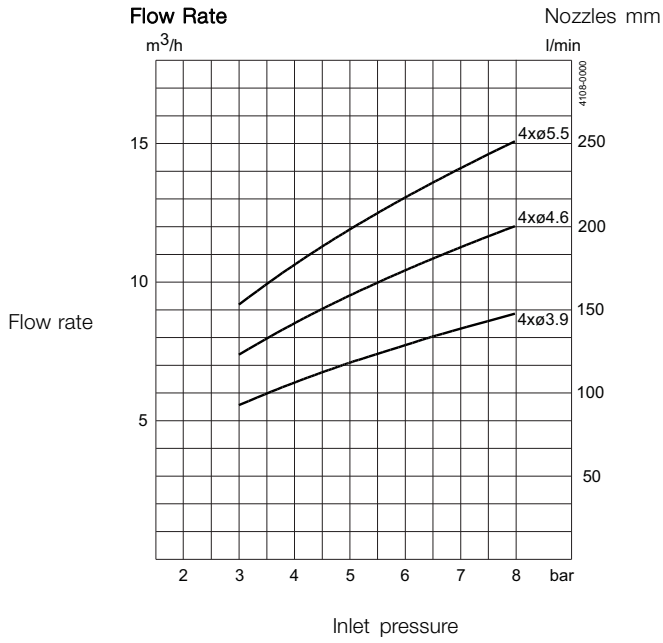

Distillery version - flow at 5 bar / 72.5 PSI
 4 x ϕ 3.9 = 10 (m^3/h)
 4 x ϕ 4.6 = 12.4 (m^3/h)
 4 x ϕ 5.5 = 13.9 (m^3/h)

Dimensions (mm)

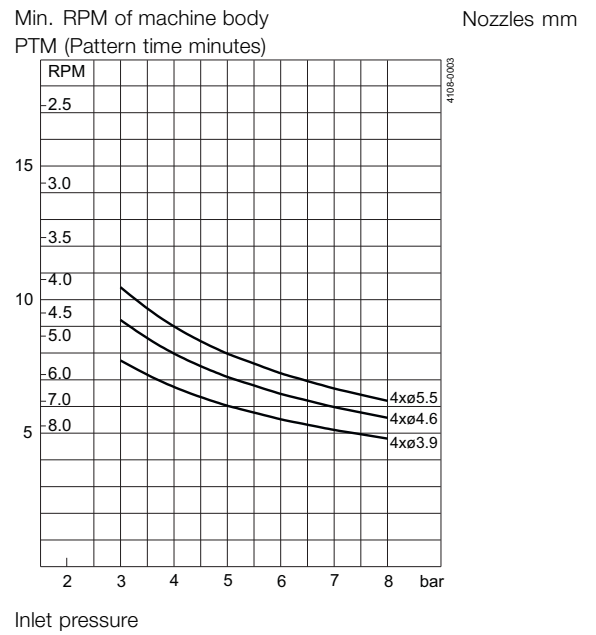
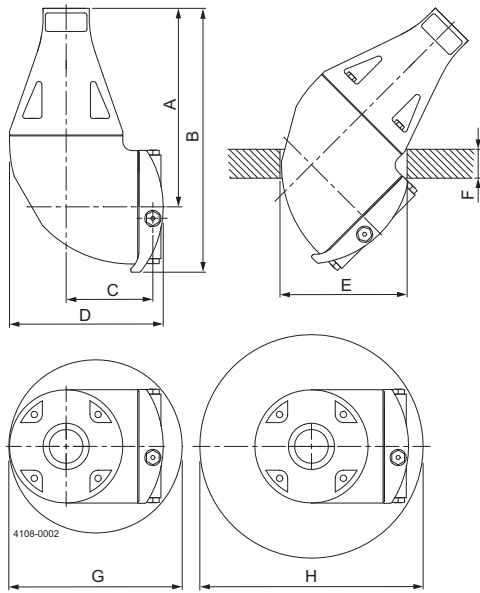

A	B	C	D	E	F	G	H
173	230	75	133	ϕ 110	max. 25	ϕ 150	ϕ 200

Standard Design

The choice of nozzle diameters can optimise jet impact length and flow rate at the desired pressure. The Toftejorg TJ 20G is also available with PEEK impeller. A welding adaptor with sealing for 1" ISO, 1" ANSI, 1 1/2" ISO Dairy Pipe or 1 1/2" SWG Pipe is available as an accessory. The hygienic construction of the Toftejorg TJ20G is designed, with the aim to meet both European and American standards and regulations, such as EHEDG, USDA, USFDA, 3A etc. The TJ20G has been tested according to the EHEDG test procedure on cleanability and in-line steam sterilisability. As standard documentation, it can be supplied with a "Declaration of Conformity" for material specifications. Special distillery version available - see Price lists.

TRAX simulation tool

TRAX is a unique software that simulates how the Toftejorg TJ 20G performs in a specific tank or vessel. The simulation gives information on wetting intensity, pattern mesh width and cleaning jet velocity. This information is used to determine the best location of the tank cleaning machine and the correct combination of flow, time and pressure to implement.

A TRAX demo containing different cleaning simulations covering a variety of applications can be used as reference and documentation for tank cleaning applications. A TRAX simulation is free and available upon request.

Wetting Intensity

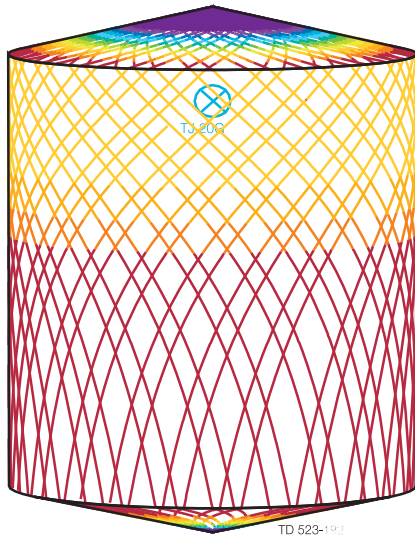
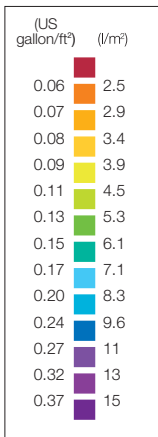

D4.6m H5.5m, Toftejorg TJ 20G, 4 x ø5.5 mm, Time = 2.08 min., Water consumption = 403 l

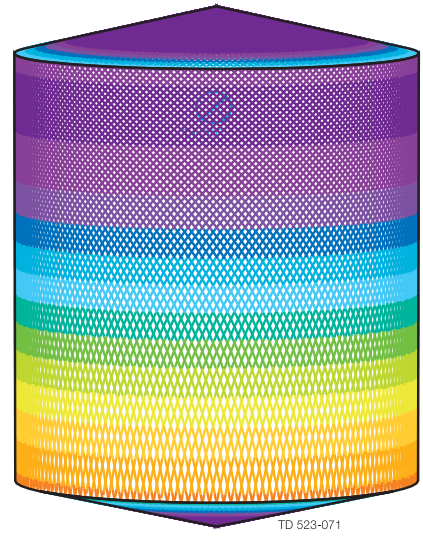

D4.6m H5.5m, Toftejorg TJ 20G, 4 x ø5.5 mm, Time = 8.3 min., Water consumption = 1612 l

Alfa Laval reserves the right to change specifications without prior notification.

How to contact Alfa Laval

Contact details for all countries
are continually updated on our website.
Please visit www.alfalaval.com to
access the information direct.