



## Alfa Laval GJ 8

### Fast, Effective Impact Cleaning

#### Application

Designed with ergonomics in mind, the Alfa Laval GJ 8 provides the same high impact clean as traditional, larger tank cleaners but is lighter, shorter, and narrower. This device is part of the world-renowned Gamajet range of high impact tank cleaning devices, and is the perfect alternative to heavy impingement cleaners, time-intensive spray balls, and costly manual tank cleaning. Compact and efficient, the Alfa Laval GJ 8 allows for space saving while maintaining the impact, durability, and range required for optimal impingement tank cleaning. This device is fluid-driven, eliminating the need for power assistance and is ideal for cleaning stubborn residues in large tanks in a variety of industries such as ethanol, paper, pulp, chemical, steel, industrial fermentation and many more applications requiring high impact cleaning.

#### Working principle

The Gamajet range of high impact tank cleaning devices combine pressure and flow to create high impact cleaning jets. Cleaning occurs at the point at which the concentrated stream impacts the surface. It is this impact and the tangential force that radiates from that point which blasts contaminants from the surface, scouring the tank interior. In conjunction with this impact, the device is engineered to rotate in a precise, repeatable and reliable, 360° pattern. This full-coverage, global indexing pattern ensures the entire tank interior is cleaned, every time.

#### TECHNICAL DATA

Lubricant . . . . . Food grade  
 Max. throw length . . . . . 14 - 26 m

#### Pressure

Working pressure . . . . . 3 - 28+ bar  
 Recommended pressure . . . . . 4 - 20 bar

#### Cleaning Pattern

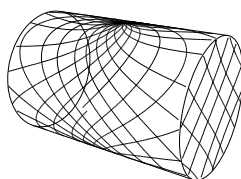

First Cycle

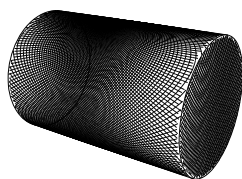

Full Pattern

The above drawings show the cleaning pattern achieved on a cylindrical horizontal vessel. The difference between the first cycle and the full pattern represents the number of additional cycles available to increase the density of the cleaning.



#### PHYSICAL DATA

##### Materials

1.4404 (316L), PPS, PTFE, FKM (EPDM and FFKM available).

##### Temperature

Max. working temperature . . . . . 95°C  
 Max. ambient temperature . . . . . 140°C

##### Weight

. . . . . 6.5 kg

##### Connections

Standard thread . . . . . 1½" Rp (BSP) or NPT, female  
 Available option . . . . . 2" Rp (BSP) or NPT, female

##### Caution

Avoid hydraulic shock, hard and abrasive particles in the cleaning liquid, as this can cause increased wear and/or damage of internal mechanisms. In general, a filter in the supply line is recommended. Do not use for gas evacuation or air dispersion. For steaming we refer to the manual.

### Flow Rate

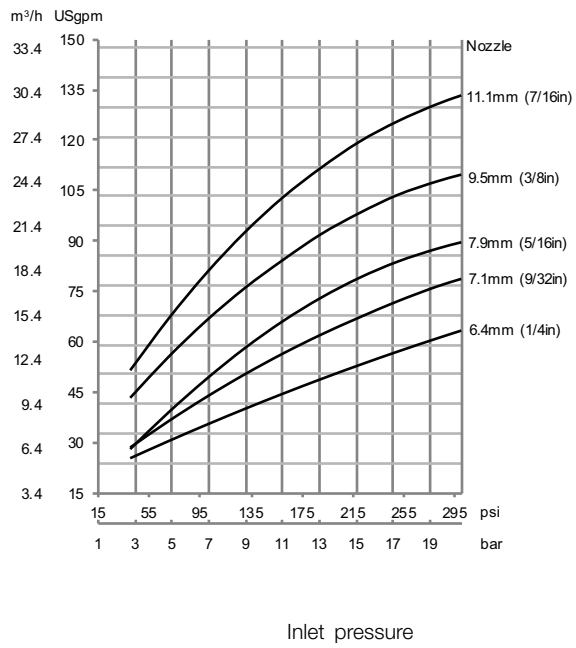

### Impact Throw Length

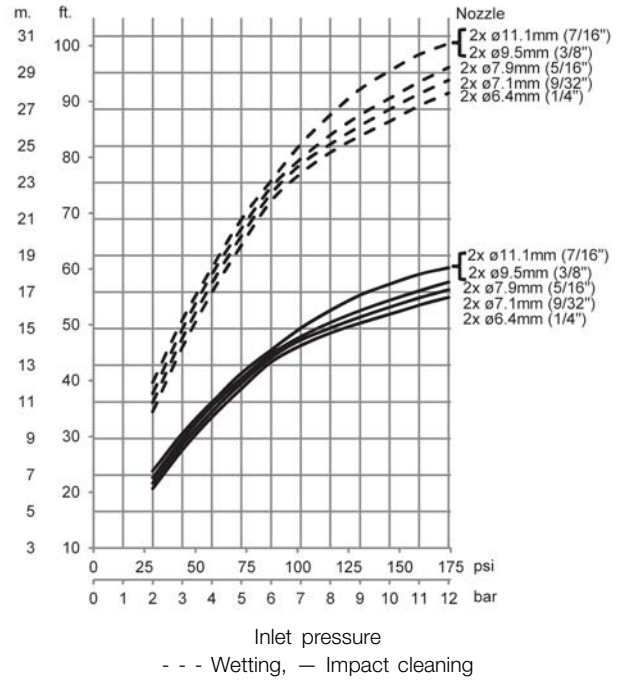

### Cleaning Time

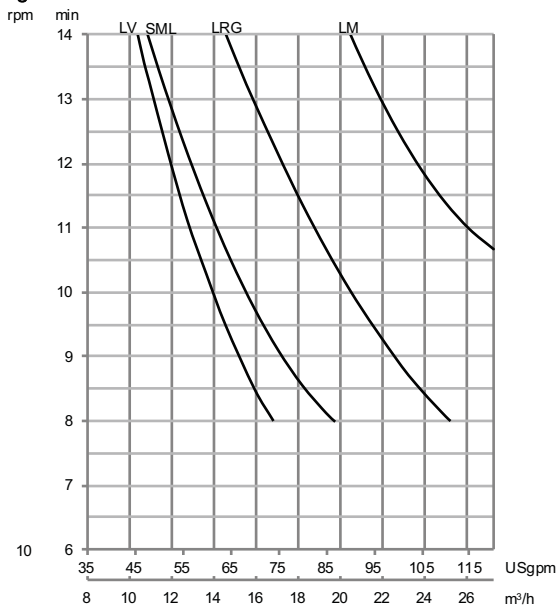

Dimensions(mm)

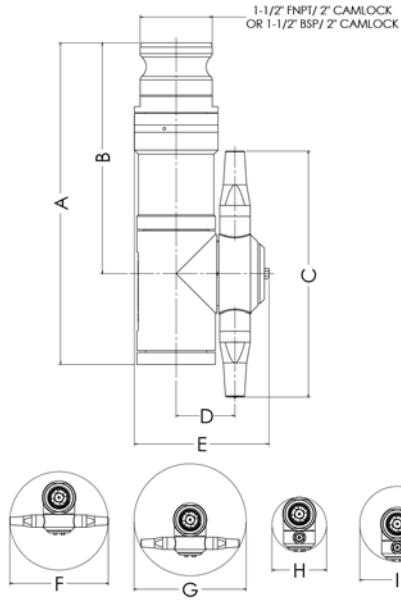

Dimensions 180° directional version

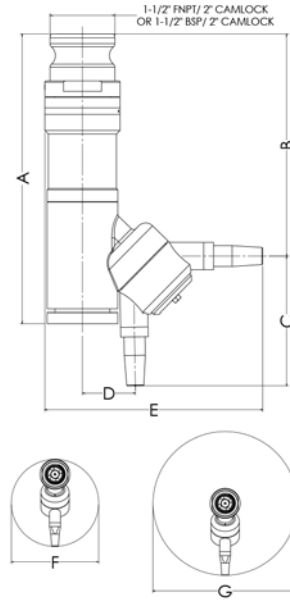

A	B	C	D	E	F	G	H	I
281	202	215	51	118	216	248	121	165

Dimensions 180° directional version

A	B	C	D	E	F	G
281	217	126	51	211	350	248

### Standard Design

The choice of nozzle diameters can optimize jet impact length and flow rate at the desired pressure. As standard documentation, the Alfa Laval GJ 8 can be supplied with a "Declaration of Conformity" for material specifications.

### TRAX simulation tool

TRAX is a unique software that simulates how the Alfa Laval GJ 8 performs in a specific tank or vessel. The simulation gives information on wetting intensity, pattern mesh width and cleaning jet velocity. This information is used to determine the best location of the tank cleaning device and the correct combination of flow, time, and pressure to implement.

A TRAX demo containing different cleaning simulations covering a variety of applications can be used as a reference and documentation for tank cleaning applications. The TRAX demo is free and available upon request.

### Wetting Intensity

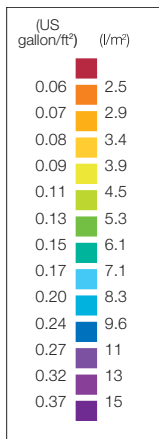

TD 523-208

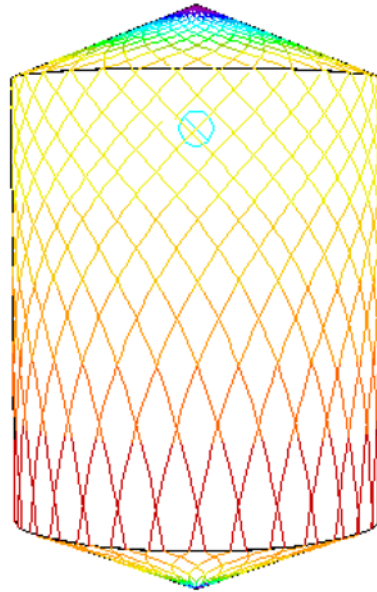

D12.2m, H19.6m, 2xØ7.94mm Time = 3.1 min.

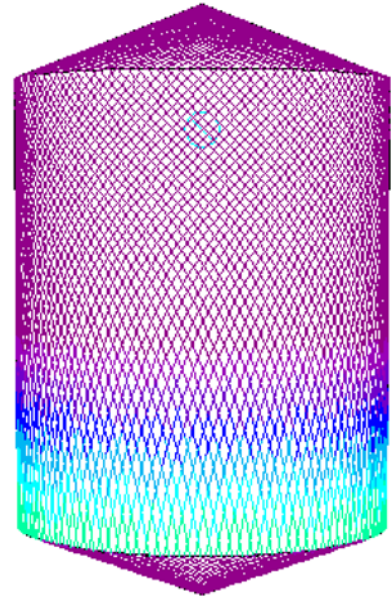

D12.2m, H19.6m, 2xØ7.94mm Time = 12.5 min.

Alfa Laval reserves the right to change specifications without prior notification.

#### How to contact Alfa Laval

Contact details for all countries are continually updated on our website. Please visit [www.alfalaval.com](http://www.alfalaval.com) to access the information direct.