

UNI-SPRAY SYSTEMS INC.

# UNI-SPRAY

- QUIK-DISCONNECT RISERS -

## Complete 'Quik-Disconnect' Riser Assemblies...

direct to you from Uni-Spray, made exactly to your specifications and ready to install. We offer a full range of our own exclusive Quik-Disconnect and third party components in a full range of sizes, including premium quality PVC, CPVC, PolyPro, Kynar and Stainless Steel pipe. To give you total design flexibility, we can custom bend the pipework for smooth flow without extra fittings to precisely meet your design configuration.

To simplify your ordering process, there are over twenty design configurations with separate worksheets for each. The worksheets allow you to enter all of the dimensions, design parameters, selection and positioning of components in a simple, fill-in-the-blank format. If you don't see exactly what you want, send us your own drawing for a quotation.

When we receive your completed worksheet or drawing, our technicians will review it for accuracy, and we will provide you with a detailed quote.

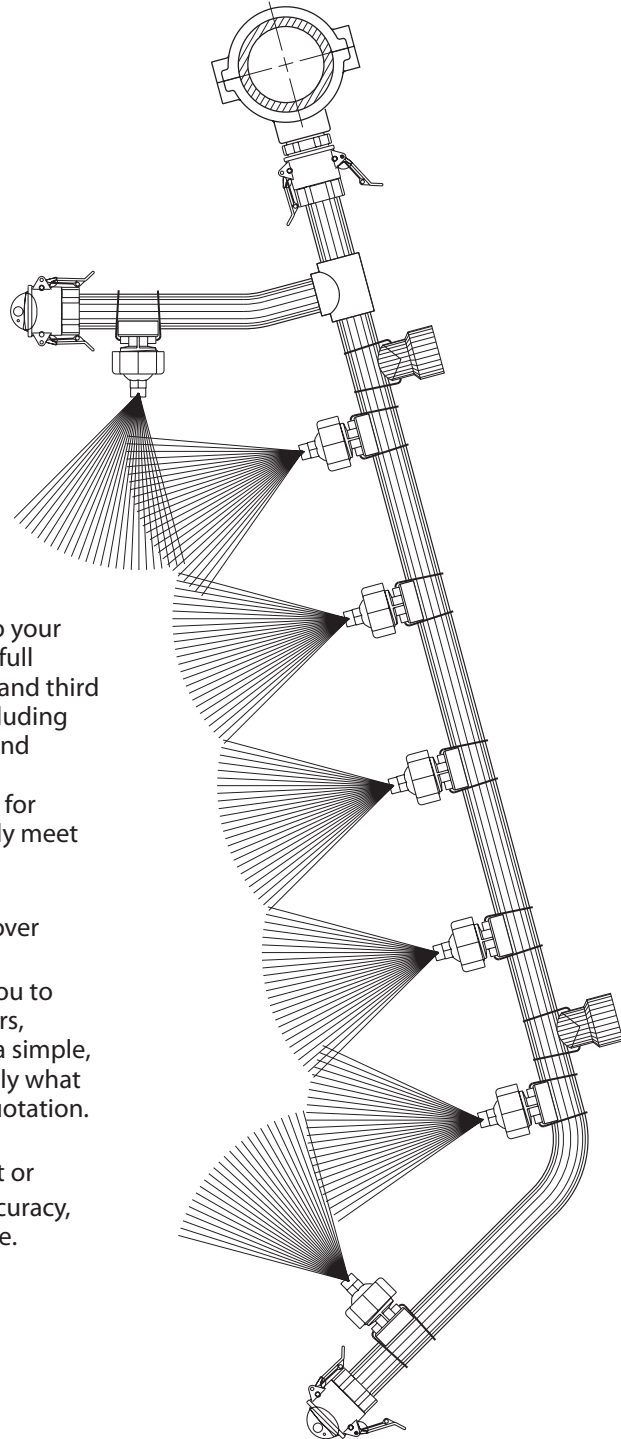

# UNI-SPRAY SYSTEMS INC.

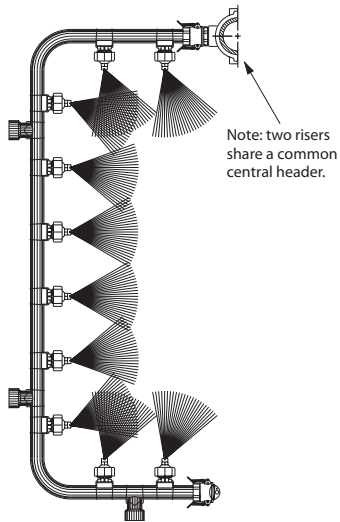

R 11T

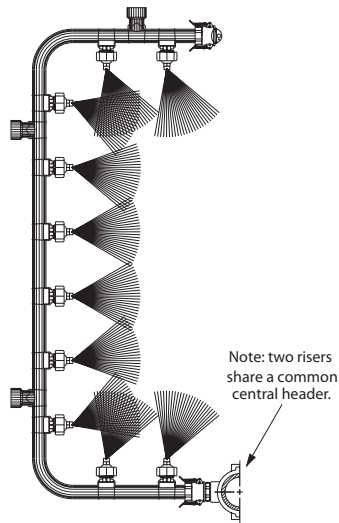

R 11B

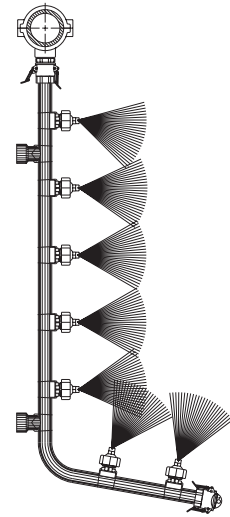

R 12T

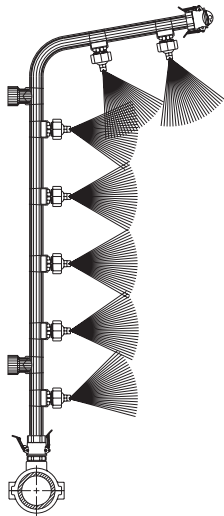

R 12B

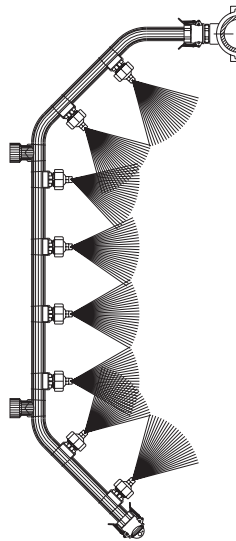

R 14T

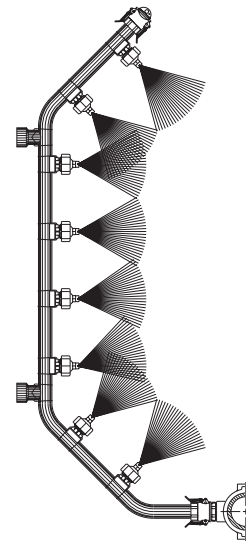

R 14B

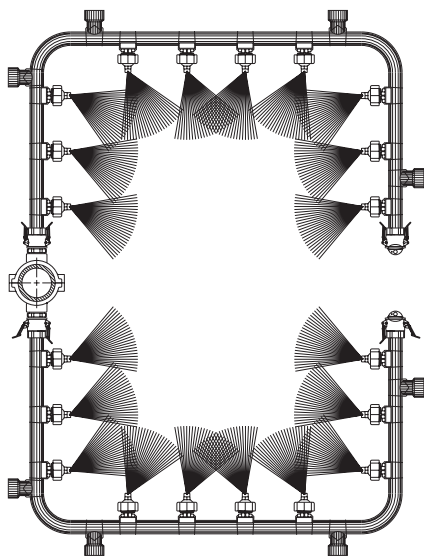

R 15C

This space is reserved for your special riser design from Uni-Spray!

MANUFACTURED BY:  
**UNI-SPRAY**

CORPORATE OFFICE:  
UNI-SPRAY SYSTEMS INC.  
44 Durward Place,  
Waterloo, Ontario, Canada N2L 4E4  
Tel: (519) 885-4270 Fax: (519) 885-4325

UNI-SPRAY SYSTEMS INC.

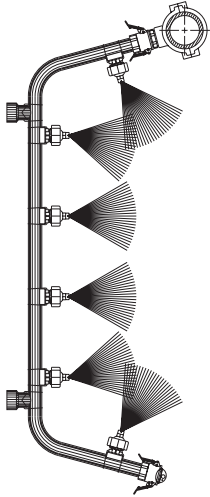

R6T

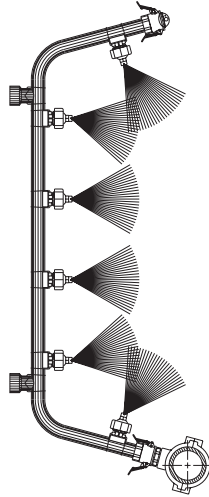

R6B

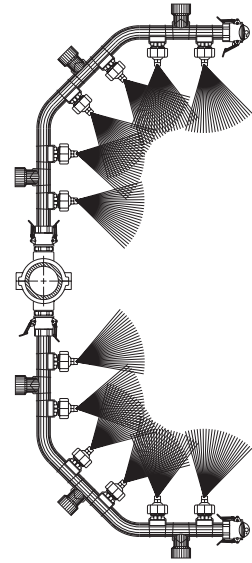

R7C

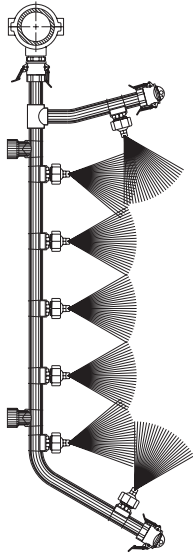

R8T

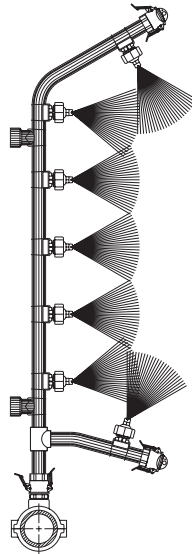

R8B

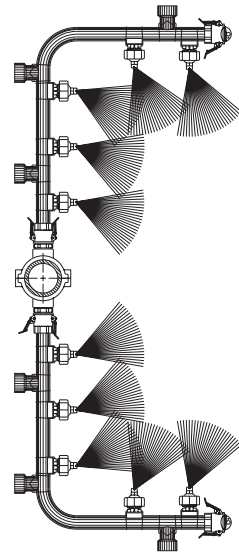

R9C

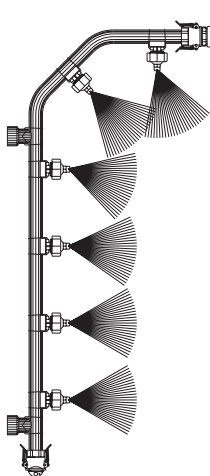

Note: two risers share a common central header.

R10T

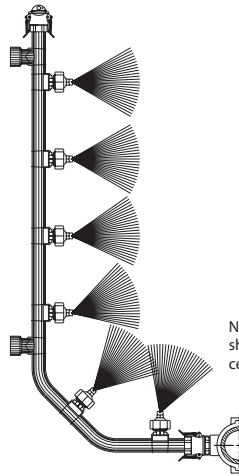

Note: two risers share a common central header.

R10B

MANUFACTURED BY:  
**UNI-SPRAY**

CORPORATE OFFICE:  
UNI-SPRAY SYSTEMS INC.  
44 Durward Place,  
Waterloo, Ontario, Canada N2L 4E4  
Tel: (519) 885-4270 Fax: (519) 885-4325

# SPRAY ANGLE SELECTION AND SPACING

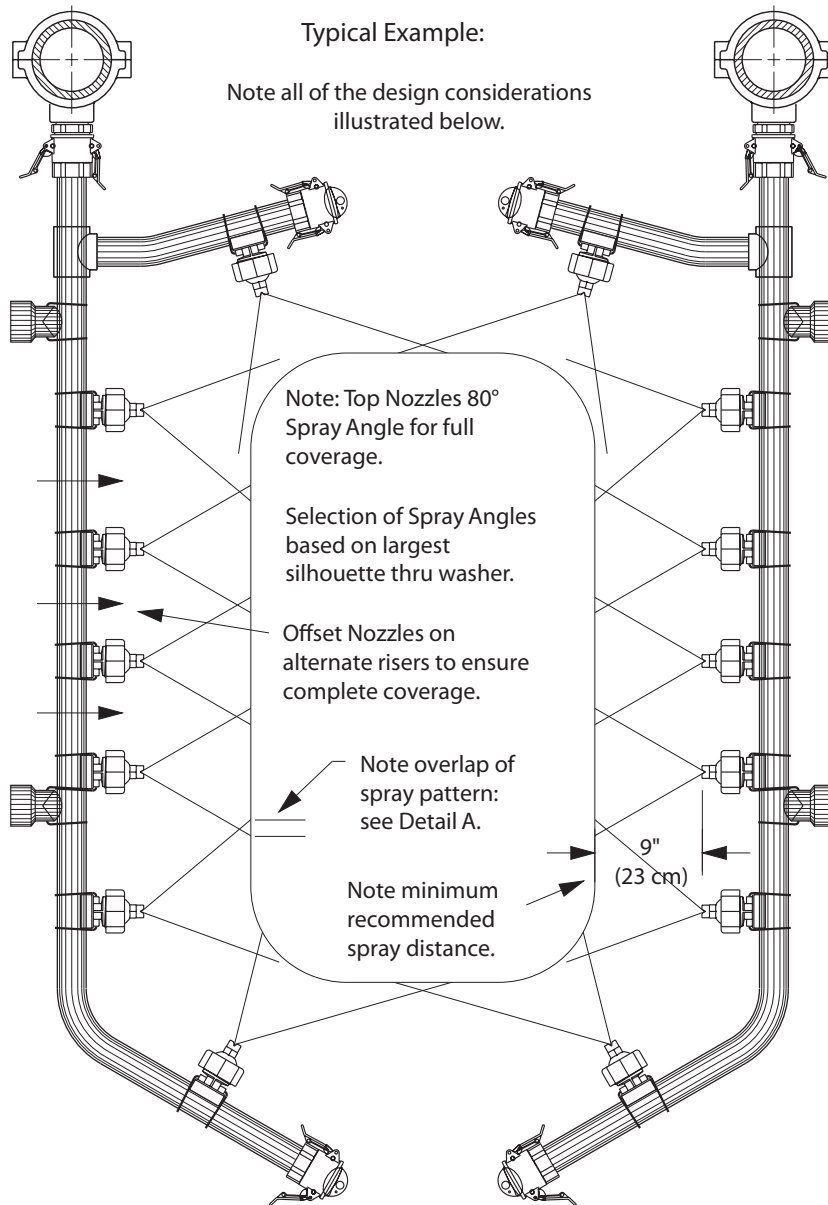

**Please Note!**

When selecting Nozzle Spray Angle, and the quantity and distance between nozzles, it is necessary to consider the size and shape of the largest ware that will pass through the washer.

Nozzles must be sized and spaced so that their sprays will cover the entire part, with at least 1" (25 mm) overlap between adjacent spray patterns. Sprays should be at least 9" (23 cm) from the end of the tip to the part for even coating. The nozzles should be rotated 15° from the riser axis to avoid interference from the overlap of spray patterns.

Failure to observe these guidelines may result in poor coating weights and banding.

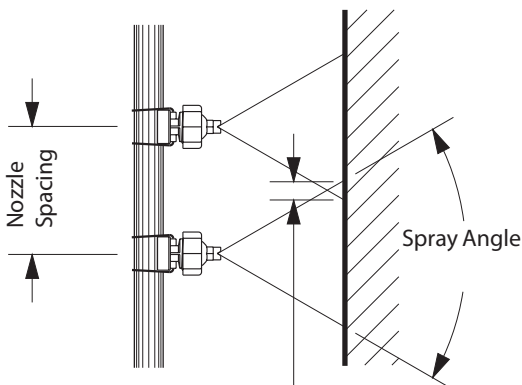
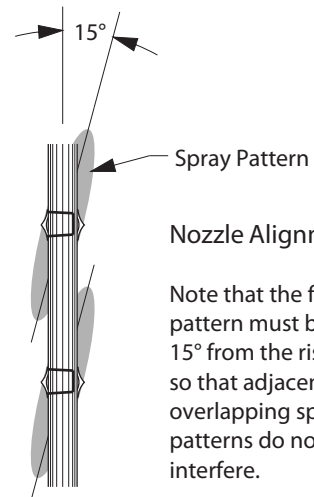

**Detail A: Nozzle Spacing**

Select Nozzle Spray Angles and Nozzle Spacing on Riser so that there is at least a 1 inch (25mm) overlap between adjacent sprays, as shown at left. This measurement must be obtained using the largest silhouette which must pass through the washer.

Incorrect Spray Angle selection and Nozzle Spacing as shown at right, can result in 'banding'.

Overlap: Correct

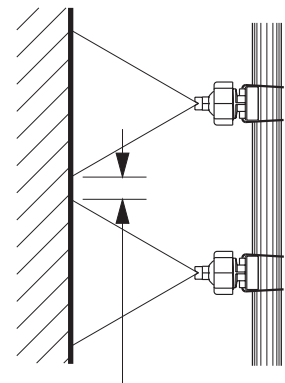

Gap: Incorrect