



Fast, effective impact cleaning for small tanks

Alfa Laval GJ 5

Application

The Alfa Laval GJ 5 offers compact cleaning for small-sized tanks, vats, and vessels. This device is designed for cleaning tanks 4.6 m (15 ft.) in diameter by 4.6 m (15 ft.) high and can easily fit through 7.62 cm (3 in.) openings. By switching from costly manual cleaning and time-intensive spray balls to the Alfa Laval GJ 5, companies are able to save a substantial amount of time, water, and money. The device is part of the world-renowned Gamajet range of high impact tank cleaning devices.

Working principle

The Gamajet range of high impact tank cleaning devices combine pressure and flow to create high impact cleaning jets. Cleaning occurs at the point at which the concentrated stream impacts the surface. It is this impact and the tangential force that radiates from that point which blasts contaminants from the surface, scouring the tank interior. In conjunction with this impact, the device is engineered to rotate in a precise, repeatable and reliable, 360° pattern. This full-coverage, global indexing pattern ensures the entire tank interior is cleaned, every time.



TECHNICAL DATA

Lubricant Food-grade
Max. throw length 1.2 - 7.5 m (4 - 24 ft.)

Pressure

Working pressure 3 - 70 bar (40 - 1,000 PSI)
Recommended pressure 4 - 40 bar (50 - 600 PSI)

Cleaning Pattern

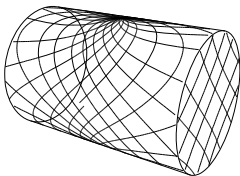

First Cycle

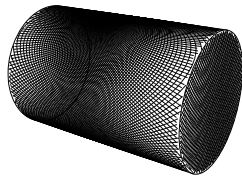

Full Pattern

The above drawings show the cleaning pattern achieved on a cylindrical horizontal vessel. The difference between the first cycle and the full pattern represents the number of additional cycles available to increase the density of the cleaning.

Certificate

2.1 material certificate

PHYSICAL DATA

Materials

1.4404 (316L), PPS, PTFE, FKM (EPDM and FFKM available)

Temperature

Max. working temperature 95°C (203°F)
Max. ambient temperature 140°C (284°F)

Weight

. 3.2 kg (7 lbs.)

Connections

Standard thread 1¼" Rp, NPT female
Available option 1½" tube weld on

Options

Electronic rotation sensor to verify 3D coverage.

Caution

Do not use for gas evacuation or air dispersion.



Disclaimer: Information in this product data leaflet is intended for general guidance purposes. Specific data for device selection and sizing is available upon request.

Flow Rate

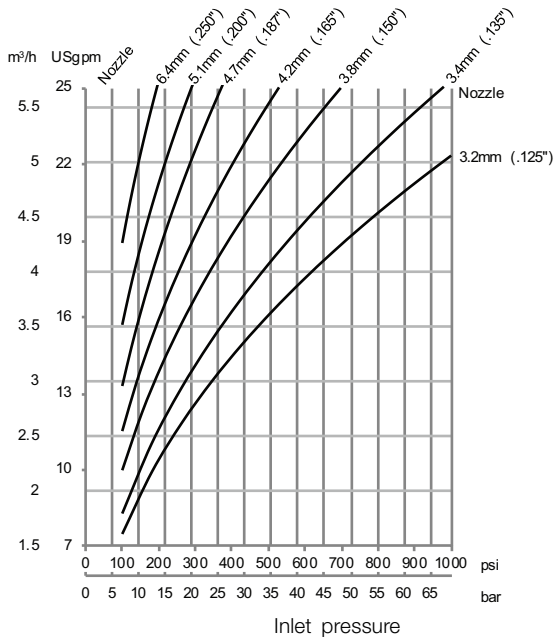

Impact Throw Length

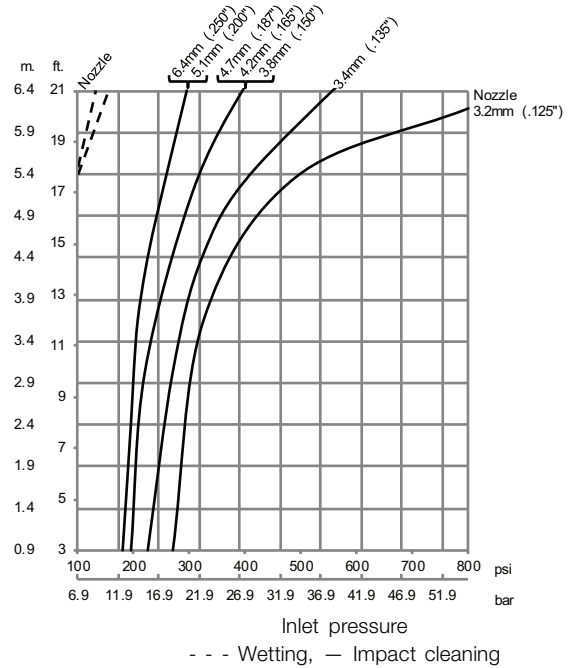

Dimensions

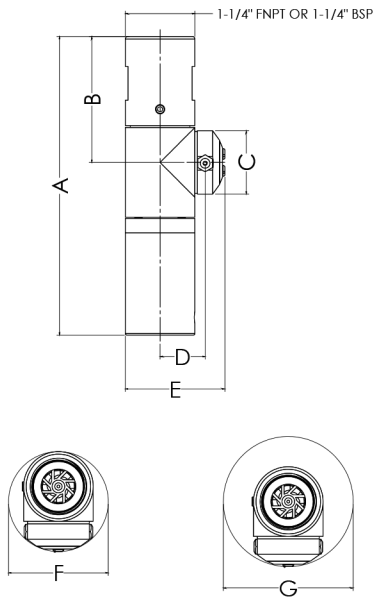

Cleaning Time

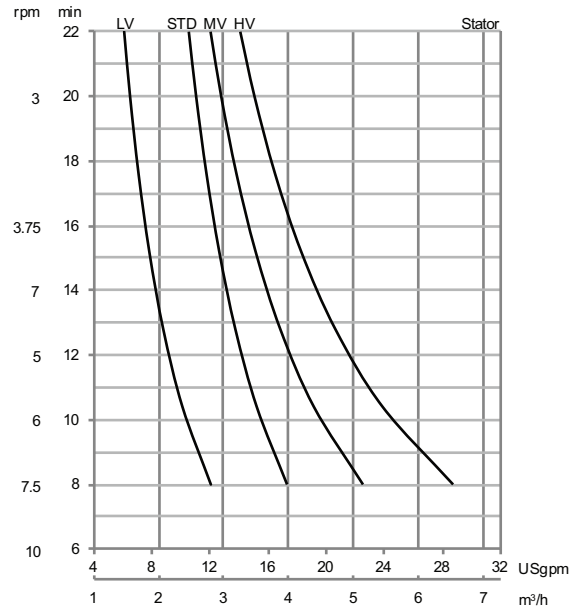

	A	B	C	D	E	F	G
mm	224	95	48	34	75	75	98
in	8.8	3.7	1.9	1.3	3	3	3.9

NOTE 1: 1" R-CLIP COLLAR OR 1-1/2" BUTT WELD

Standard Design

The choice of nozzle diameters can optimize jet impact length and flow rate at the desired pressure. As standard documentation, the Alfa Laval GJ 5 can be supplied with a "Declaration of Conformity" for material specifications.

TRAX simulation tool

TRAX is a unique software that simulates how the Alfa Laval GJ 5 performs in a specific tank or vessel. The simulation gives information on wetting intensity, pattern mesh width and cleaning jet velocity. This information is used to determine the best location of the tank cleaning device and the correct combination of flow, time, and pressure to implement.

A TRAX demo containing different cleaning simulations covering a variety of applications can be used as a reference and documentation for tank cleaning applications. The TRAX demo is free and available upon request.

Wetting Intensity

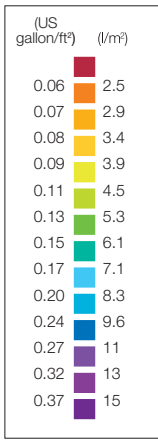

TD 523-208

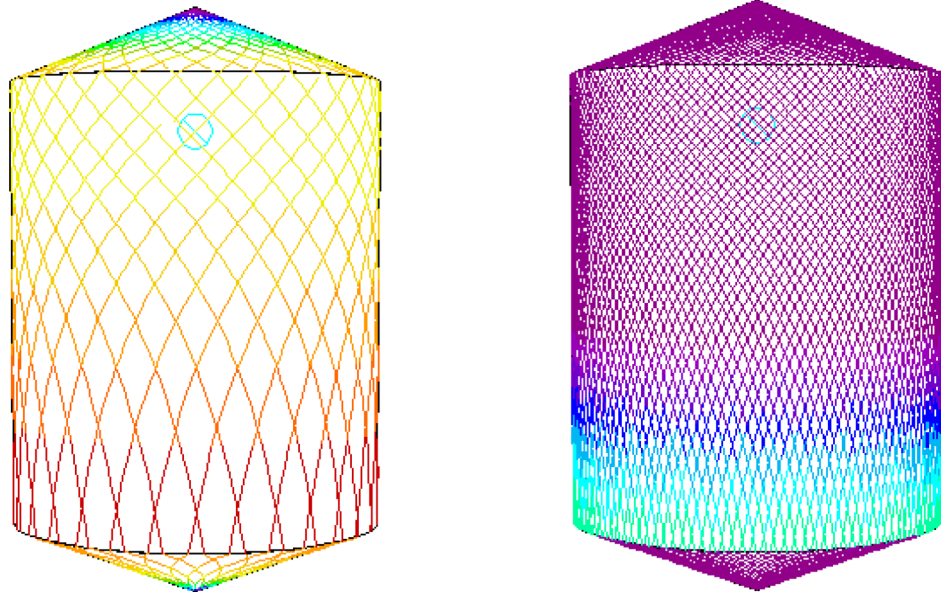

D4.8m (190"), H7.6m (300"), 2xØ4.76mm (2xØ3/16") Time = 2.75 min. D4.8m (190"), H7.6m (300"), 2xØ4.76mm (2xØ3/16") Time = 11 min.

Alfa Laval reserves the right to change specifications without prior notification. ALFA LAVAL is a trademark registered and owned by Alfa Laval Corporate AB.

ESE02999EN 1015

© Alfa Laval

How to contact Alfa Laval

Contact details for all countries are continually updated on our website. Please visit www.alfalaval.com to access the information direct.